



DAX-8823-BG



BATHTUB FILLERS **SERIES**





## FEATURES

- Free Standing with Gooseneck spout
- Brushed gold finish
- Flow Rate: Handle 2.2 GPM at 60 PSI  
Spout 2.5 GPM at 79 PSI
- Ceramic Cartridge
- Water lines and mounting parts included

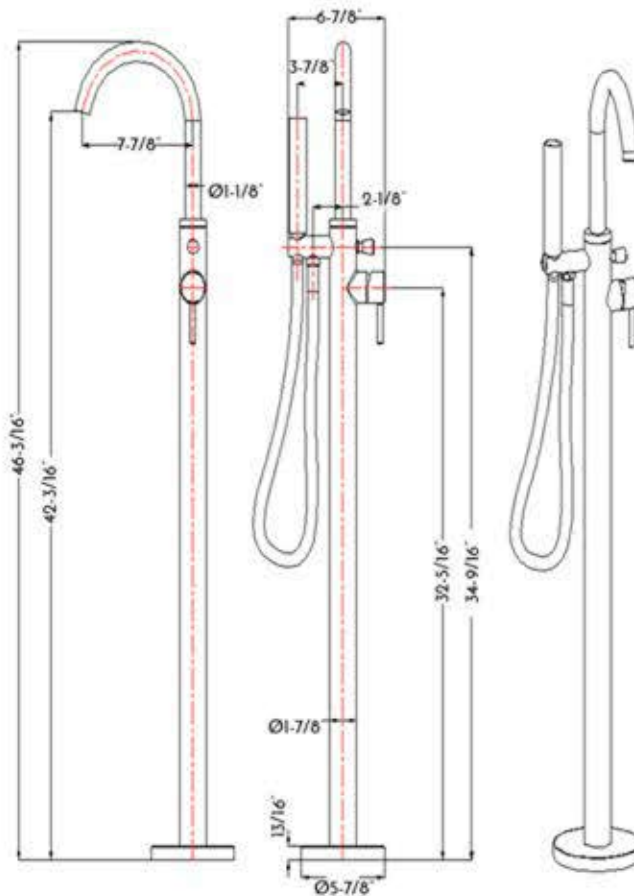



**BATHTUB FILLER DAX-8823-BG**

MODEL	DAX-8823-BG
MATERIAL	Brass
FINISH	Brushed gold
HEIGHT	45-1/2"
SPOUT HEIGHT	40-7/8"
SPOUT REACH	7-7/8"
FLOW RATE	2.2 GPM
HOT COLD INDICATORS	No
DECK PLATE INCLUDED	No
COMPATIBLE VALVE TYPE	Ceramic Cartridge
HANDLE STYLE	Single Handle
NUMBER OF HANDLES	One
HOSE LENGHT	-
FAUCET HOLES	One
FAUCET HOLE SIZE	1-15/16"
INSTALATION TYPE	-
SPOUT SWIVEL	-
MAX DECK THICKNESS	-

For parts or sale requirements  
please contact our customer service department:



[CS@daxib.com](mailto:CS@daxib.com)



1 888 685 8236



DAX-8823

**For easy installation of your faucet, please ensure the following:**

Read thoroughly all the instructions before installing the faucet.

Read and understand all warnings

Check all the components in the package.

**PLEASE CAREFULLY READ THIS INSTRUCTIONS MANUAL BEFORE INSTALLING AND USING THE PRODUCT.**

**PLEASE KEEP THIS INSTRUCTION MANUAL FOR FUTURE REFERENCE REGARDING PRODUCT OPERATION AND MAINTENANCE.**

**Attention: Before you install the faucet,**

- 1) Please make sure the direction of the faucet should face to.
- 2) Please divided the hot water and cold water.
- 3) Please make sure you shut off the water supply.

**Tools you may need.**

					
Electric drill	Safety goggles	Adjustable wrench	Pliers	Screwdriver	Pencil

For parts or sale requirements please contact our customer service department:

 [CS@daxib.com](mailto:CS@daxib.com)



1 888 685 8236



### Cleaning and Care

Care should be exercised when cleaning this product. Although its finish is durable, it can be damaged from harsh abrasives and cleaning pads. To clean, use light, non-abrasive cleaning solution or cleaning polish.

### Package contents:

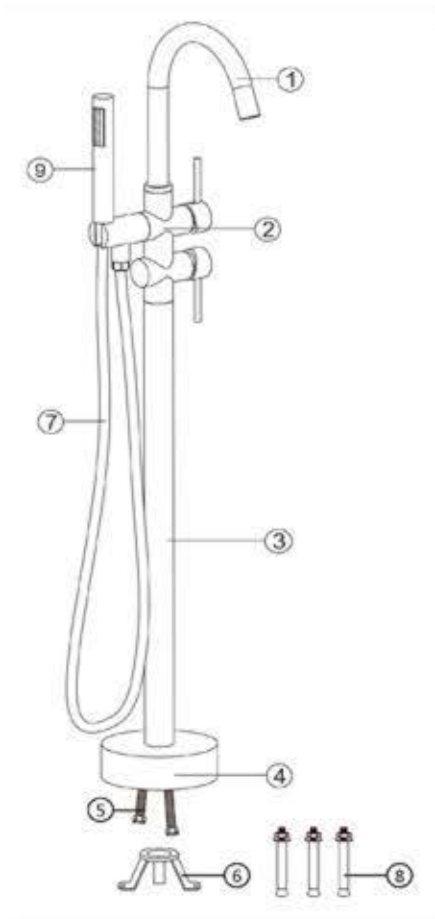

### Accessory list:

- 1) Tub filler spout
- 2) Mixer
- 3) Standpipe
- 4) Escutcheon
- 5) Inlet supply line (2 pcs)
- 6) Permanent seat
- 7) Shower hose
- 8) Expansion screw (3 pcs)
- 9) Hand shower

For parts or sale requirements please contact our customer service department:

 [CS@daxib.com](mailto:CS@daxib.com)



1 888 685 8236



Installation steps

- 1 Place the escutcheon (#4) over the standpipe (#3) and push it to the base, then turn the permanent seat to standpipe

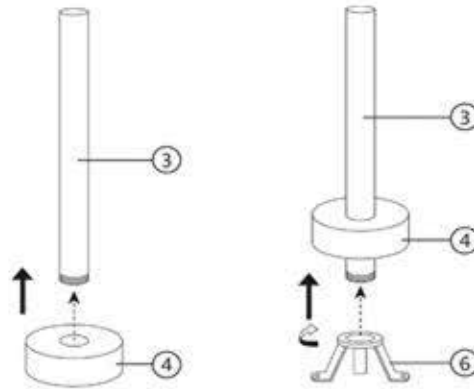

- 2 Ture the inlet supplies to mixer, verify the hot one with red line and the cold one with the blue line. Attach the mixer (#2) to the standpipe (#3).

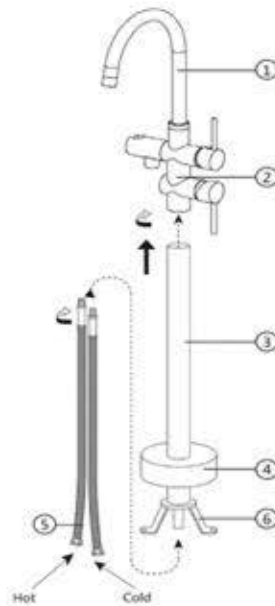

For parts or sale requirements  
please contact our customer service department:

✉ [CS@daxib.com](mailto:CS@daxib.com)



1 888 685 8236



- 3 Making sure the prongs on the top of standpipe (#3), insert into the hole of the mixer (#2). Install the set and tighten into the standpipe (#3)

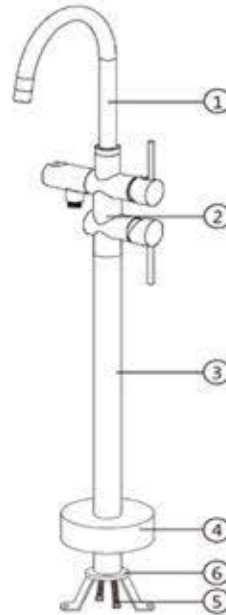

- 4 Mark the locations for the screws with a pencil. With an electric drill , drill three holes for the expansion screws (#8) in the floor. Place the expansion screw (#8) into the holes. Connect the flexible supply lines (#5) to the water supplies.

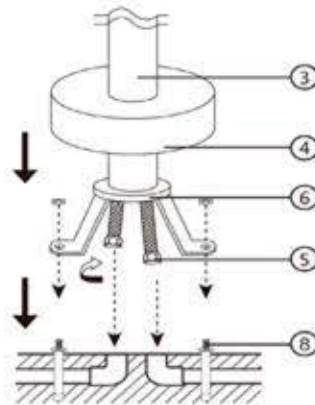

For parts or sale requirements  
please contact our customer service department:

✉ [CS@daxib.com](mailto:CS@daxib.com)



1 888 685 8236



- 5 Ensure the standpipe (#3) sits flush against the finished floor surface. Then secure the standpipe(#3) using screws (#8). Push the escutcheon (#4) over the standpipe (#3) base so that it sits flush against the finished floor surface.

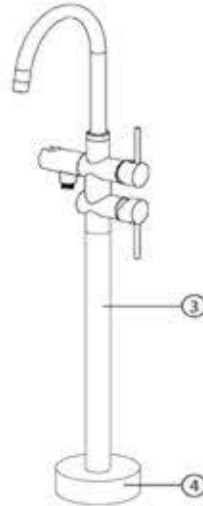

- 6 Connect one end of the shower hose (#7) to the mixer (#2) and the other end to the showerhead (#9). Ensure the washer is placed into each end for seal.

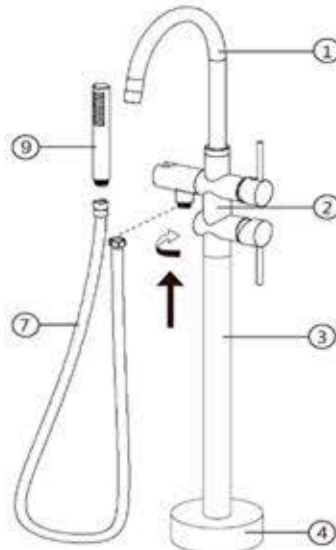

Note: This instruction manual is written for universal use and may be subjected to specification variance of actual parts.

For parts or sale requirements please contact our customer service department:

✉ [CS@daxib.com](mailto:CS@daxib.com)



1 888 685 8236