



DAX-478-BN



KITCHEN FAUCETS SERIES



www.daxib.com

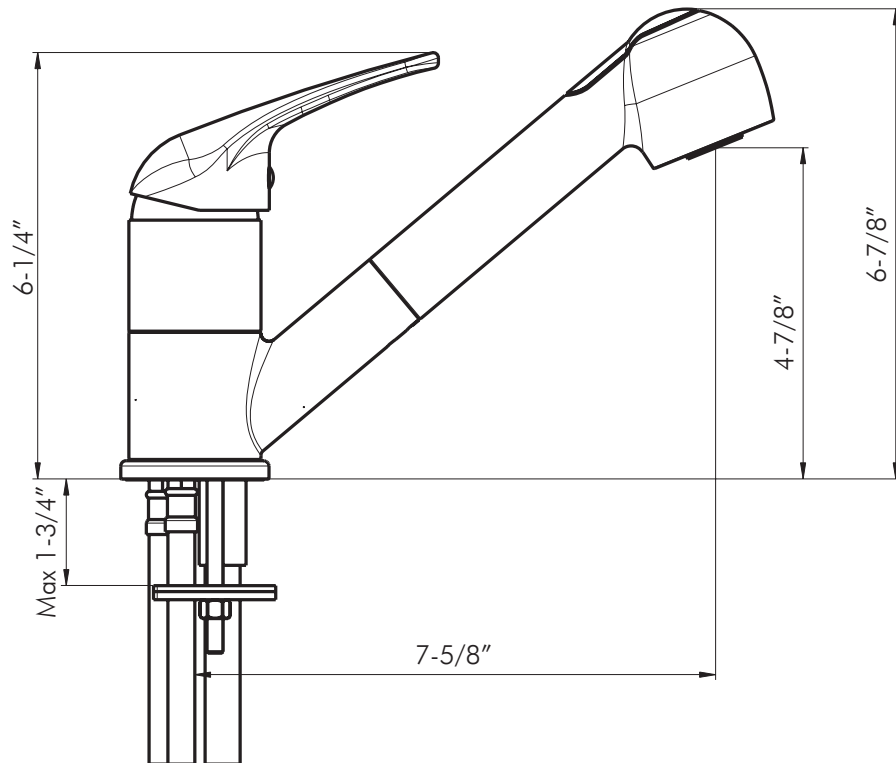

FEATURES

- Pull out shower head
- Brass body casting
- Dual sprayer
- ABS shower head
- Ceramic cartridge
- Flow rate 1.8 GPM
- Height 6-7/8"
- Installation hole 1-3/8"
- Water lines and mounting parts included





KITCHEN FAUCET **DAX-478-BN**

MODEL	DAX-478
ADA	Y
UPC APPROVED	Comply
ANSI APPROVED	Comply
ASME APPROVED	Comply
WATERSENSE CERTIFIED	N/A
NSF APPROVED	Y
CONNECTION SIZE	9/16"
FAUCET HOLE SIZE	1-3/8"
FAUCETS HOLE	1
FAUCET TYPE	Pull out
FLOW RATE (GPM)	1.8
HANDLE STYLE	Single
NUMBER OF HANDLES	1
HOSE LENGTH	19-11/16"
MATERIAL	Brass
FINISH	BN
PULL OUT SPRAY	2 Function
SIDESPRAW	N/A
SPOUT REACH	7-5/8"
SPOUT SWIVEL	Y
CARTRIDGE TYPE	Ceramic
MAX DECK THICKNESS	N/A
INCLUDED COMPONENTS	N/A





01

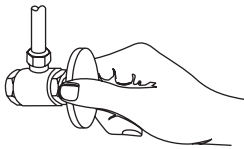

You should clean all the dirt from valve outlets. Turning off the water supply valves. This is usually found near the water meter. If you are replacing an existing faucet, remove the faucet from the sink and clean the sink surface thoroughly.

02

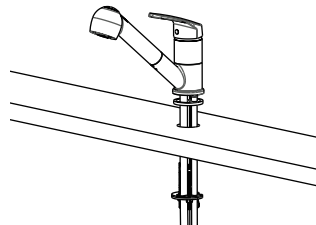

Install without Deck Plate. Make sure the O-RING is placed onto the bottom of Base Ring. Install faucet through hole in sink. From underside sink, put Plastic Washer and Mounting Nut. Position faucet on sink properly and tighten Mounting Nut.

2A

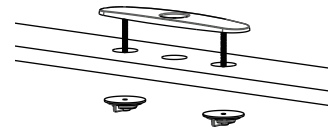

Install with Deck Plate. Place a bead of plumber's putty between faucet and sink. Place Deck Plate over the three holes of sink. From underside sink, tighten Wing nut.

2B

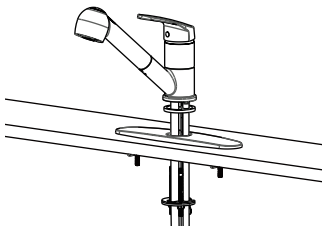

Make sure the O-RING is placed onto the bottom of Base Ring. Install faucet through Deck Plate. From underside sink, put Plastic Washer and Mounting Nut. Position faucet on sink properly and tighten Mounting Nut.

03

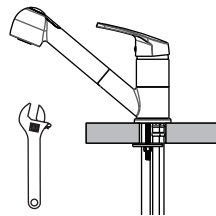

If necessary, tighten screws using an adjustable wrench until the faucet is firmly connected to the sink.

04

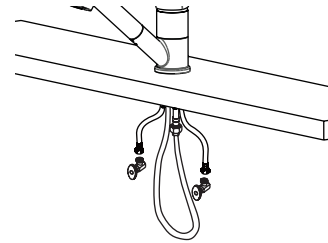

Connect hot and cold water supply lines to the Water Supply Valves.





05

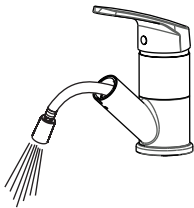

After installation is complete, remove Spray head and rotate handle to the close position. Turn Water Supply Valves on, and check all connections for leak. Flush faucet by running hot and cold water in full position for one minute.

06

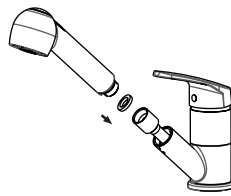

Replace Spray head.

07

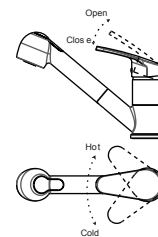

Lift the handle up, the cartridge will be activated allowing water to flow. The water flow will increase by continuing to rotate handle. By rotating the handle to the right, the water temperature will decrease to cold flow only. By rotating Handle to the left, the water temperature will increase to hot only.

08

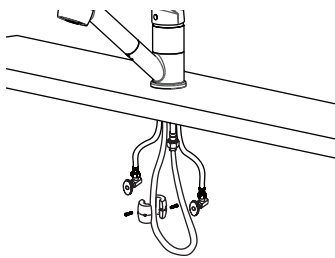

Attach Weights to the pull-out hose using screws at the proper point of the hose. Be noted Weights are optional.

Handle Removal Maintenance

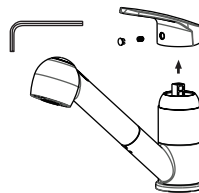

Turn off water and relieve pressure! Detach handle button using a small flathead screwdriver, unscrew set screw using Allen Wrench and take off handle.

Valve Cartridge Removal Maintenance

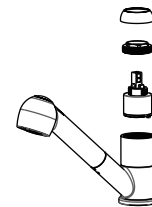

Remove handles. Unscrew Dome Cap counter clockwise by hand. Unscrew Retaining Nut using adjustable wrench, take out cartridge assembly and inspect. Replace parts as necessary. Reassemble parts by reversing steps.





DIAGRAM NUMBER	DAX SKU	TITLE DESCRIPTION
1	A	Faucet
2	B	Spray Head
3	C	Flexible Hoses(3)
4	D	Pull-out hose
5	E	Mounting Nut
6	F	Weight(1) + Screw (2)
7	G	Brass Adaptor + Back Pressure Valve
8	H	Allen Wrench

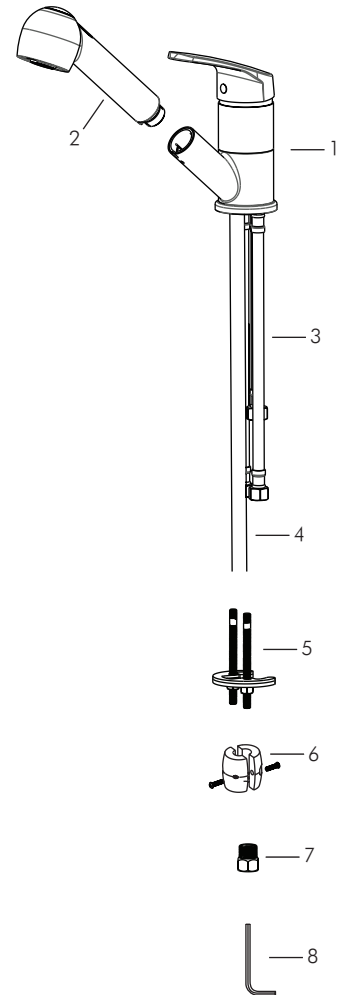

For parts or sale requirements please contact our customer service department:

 CS@daxib.com

 1 888 685 8236

