



2260359



TOILET PAPER HOLDERS **SERIES**
BY COSMIC



BY
COSMIC

www.daxib.com



MEASUREMENTS

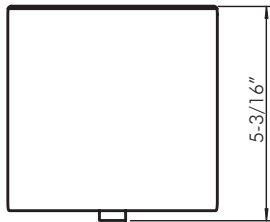
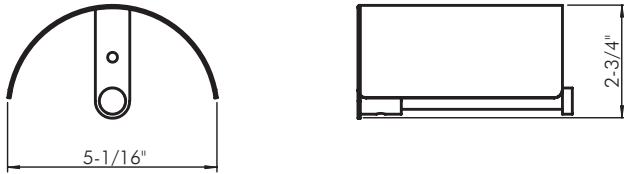

DIMENSIONS

5-1/16" x 2-3/4" x 5-3/16"

INSTALLATION GUIDE

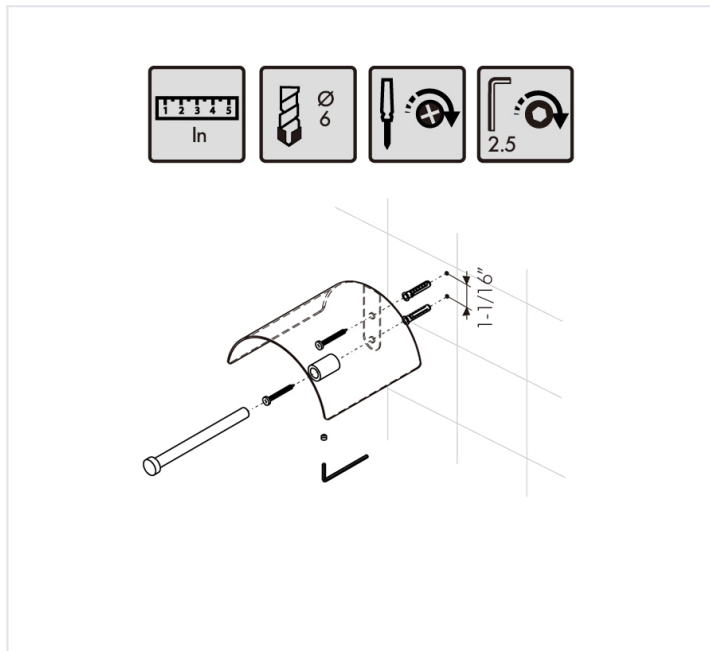

For parts or sale requirements
please contact our customer service department:



CS@daxib.com



1 888 685 8236

BY
COSMIC