



DAX-2002



SHOWER SYSTEMS SERIES



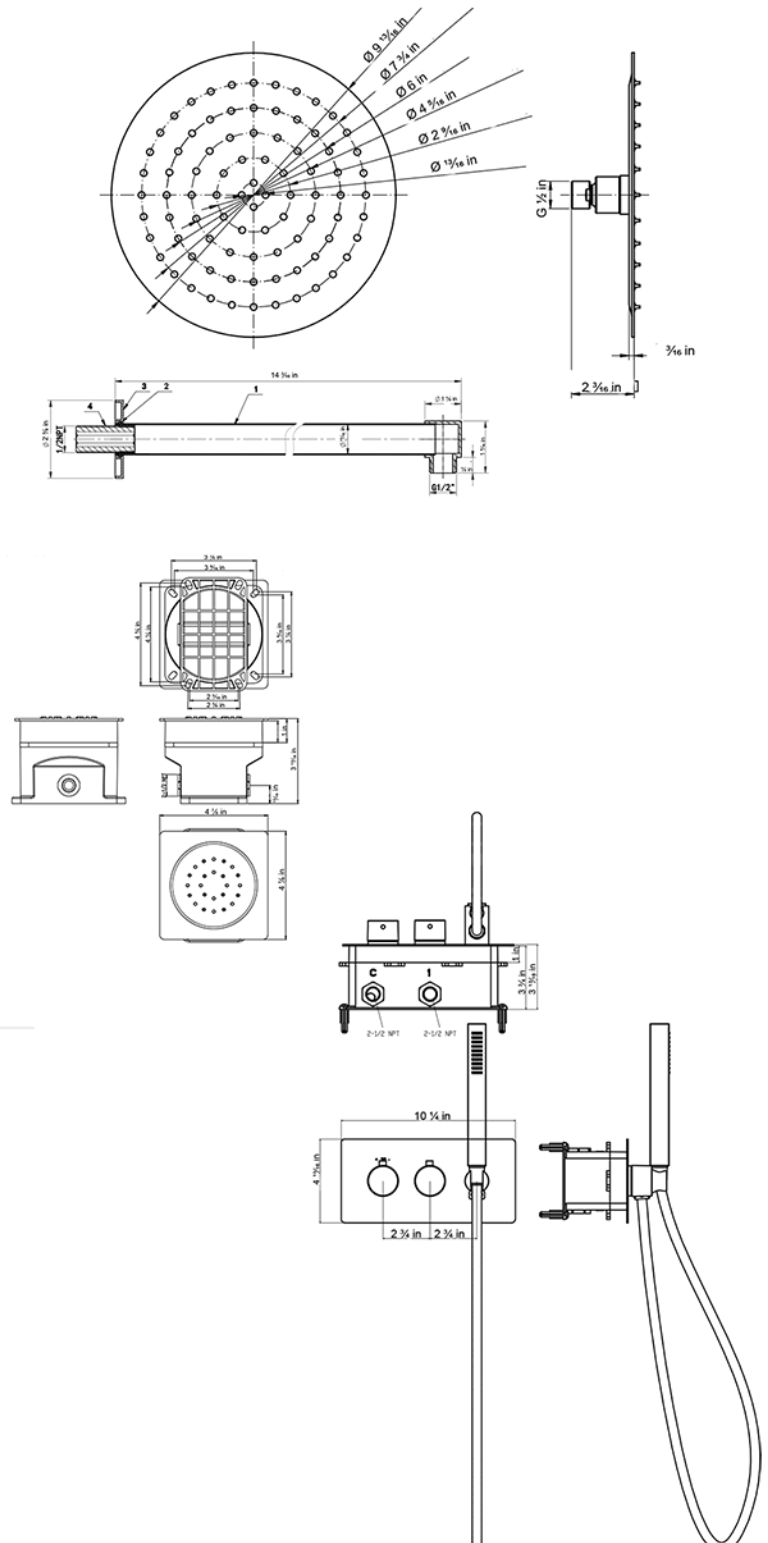

FEATURES

- Shower System
- Thermostatic Mixer
- Stainless Steel
- Chrome Finish





SHOWER SYSTEM DAX-2002

| | |
|--------------------------------|--------------------------------|
| MODEL | DAX-2002 |
| ADA | NO |
| UPC APPROVED | YES |
| ANSI APPROVED | NO |
| ASME APPROVED | NO |
| BODYSPRAYS INCLUDED | YES |
| NUMBER OF BODYSPRAYS | 6 |
| BODYSPRAYS CONNECTION SIZE | NPT 1/2" FEMALE |
| HAND SHOWER FLOW RATE (GPM) | 2.5 |
| SHOWER HEAD FLOW RATE (GPM) | 2.5 |
| ROUGH-IN VALVE FLOW RATE (GPM) | 7.9 |
| HANDLE MATERIAL | BRASS |
| HANDLE STYLE | WALL MOUNTED |
| HAND SHOWER INCLUDED | YES |
| HAND SHOWER HOSE INCLUDED | YES |
| HAND SHOWER HOSE LENGTH | 1.5M |
| INSTALLATION TYPE | CONCEALED |
| MATERIAL | STAINLESS STEEL 304 & BRASS |
| PRESSURE BALANCE | NO |
| SCALD GUARD | YES |
| SHOWER ARM REACH | YES |
| SHOWER ARM CONNECTION SIZE | NPT 1/2" MALE |
| SHOWER HEAD | YES |
| SHOWER HEAD HEIGHT | 2.2M |
| SHOWER HEAD SHAPE | CIRCLE |
| SHOWER HEAD WIDTH | 9-13/16" |
| SLIDE BAR INCLUDED | NO |
| SLIDE BAR DIMENSION | / |
| SPRAY PATTERN | RAIN, BODY SPRAY & HAND SHOWER |
| THERMOSTATIC | YES |
| VALVE INCLUDED | FRENCH VENET |
| VALVE TYPE | THERMOSTATIC |
| WATER EFFICIENT | YES |
| WATERSENSE CERTIFIED | NO |
| WALL ELBOW DIMENSION | NPT 1/2" |
| FINISH | BRUSHED S.S |





01 ① →

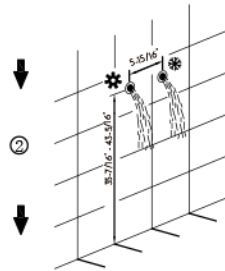

③ →

Flush the water supply lines thoroughly to drain debris and impurities. Shut off the water before installation.

02

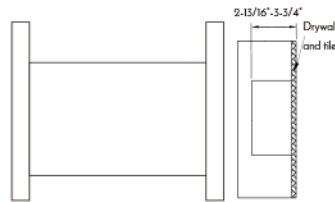

Fix a wood plate to the two wood pipes for faucet installation.

03

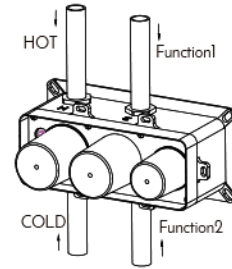

Design the pipelines connection inside the wall according to the function chart.

04

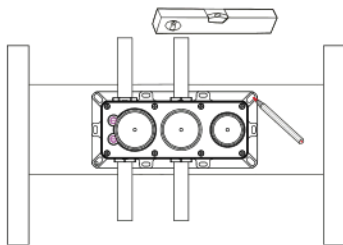

Put the installation box on the wood plate. Measure the correct position with level and marks.

05

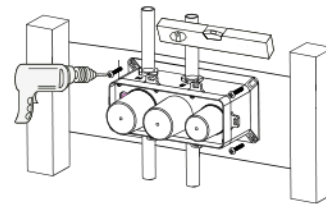

Screw the installation box to the wood plate.

06

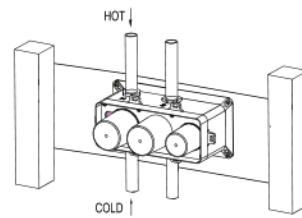

Connect hot and cold water pipes and all outlets accordingly and test the leakage.

07

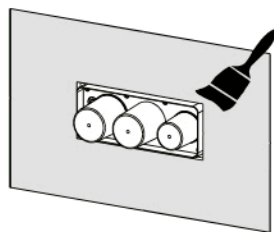

Create a dry wall around the installation box and brush with water proof glue.

08

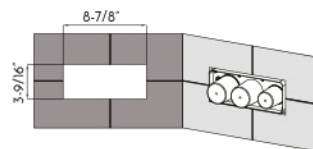

Leave a hole on tile covering according to chart dimensions and real product size. Use silicone along the installation box to seal.

09

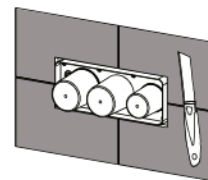

Cut the excess part of installation box. Make sure there are no bump edges above tiles.





10

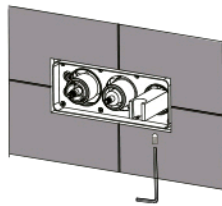

Take away the plastic protection cups on the valve. Insert the shower holder body into the socket in the wall. Be aware of the direction and fix the holder with screw.

11

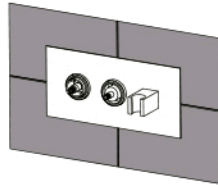

Insert the stainless steel plate. Consider the correct direction of plate.

12

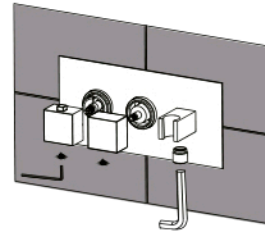

Install the handles and connector with allen keys. Test and make sure all the functions are closed when handle is pointed at OFF position.

13

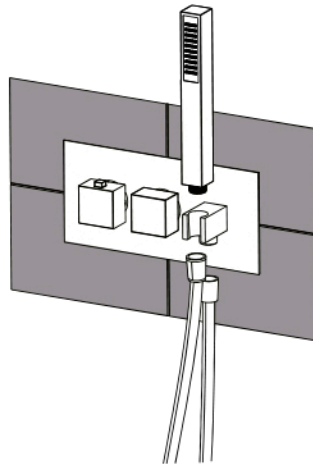

Connect the shower hose with hand shower and hose connector to complete the installation.





| DIAGRAM NUMBER | DAX SKU | TITLE DESCRIPTION |
|----------------|---------|-------------------|
| 1 | | |
| 2 | | |
| 3 | | |
| 4 | | |
| 5 | | |
| 6 | | |
| 7 | | |
| 8 | | |
| 9 | | |
| 10 | | |
| 11 | | |
| 12 | | |

