



BSN-715



CERAMIC VESSEL SINKS SERIES



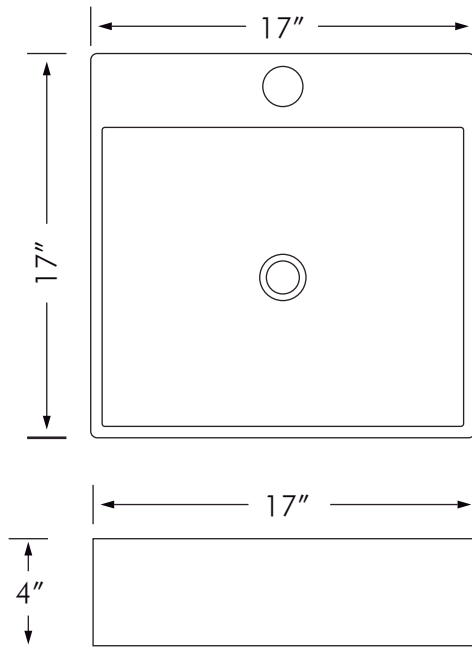

FEATURES

- Ceramic material
- White gloss finish
- Pop up drain not included (available)
- Vessel installation
- Size W 17" x H 17" x D 4"





01

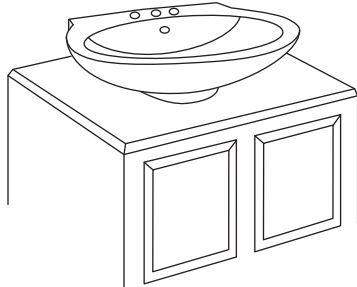

Choose the location on the vanity top where you will install the countertop basin. Make sure there is enough space under the counter for the water lines and the drain. Also, ensure that the space between the back of the basin and the backsplash (or the wall) is large enough for the faucet.

02

The outside diameter of the drain hole will have to be drawn and cut. You will have to measure precisely the center of the drain and trace it on the vanity. Before cutting the counter, make sure it is centered on the vanity and centered in the basin. (see illustration 2).

03

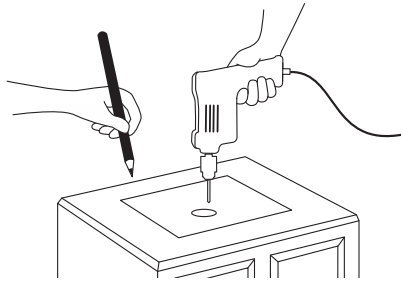

Confirm that the mark on the vanity lines up with the basin you have chosen and that it is centered. Then cut the hole the size of the pipe (see illustration 2).

04

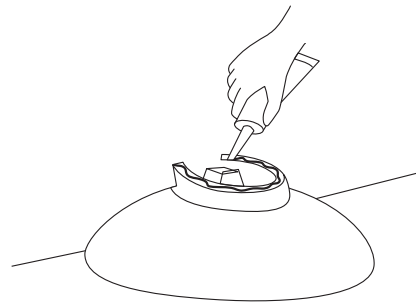

Place the countertop basin on the hole. Ensure it is centered and that there is enough space for it to lay flat. After these verifications, take it back, turn it upside down and apply a generous portion of silicone adhesive under the basin (see illustration 3).

05

After silicone adhesive has been applied, carefully install the basin on the countertop and press down firmly and trim any excess sealant.

06

WARNING: If you install the plumbing immediately after applying the silicone, without waiting for it to harden, once you finish installing the faucet, water lines and drain make sure the basin has not moved when you tightened the pipes. If it moved, replace it immediately.

07

Allow silicone to dry for 24 hours before using the washbasin.

For parts or sale requirements please contact our customer service department:

 CS@daxib.com

 1 888 685 8236