

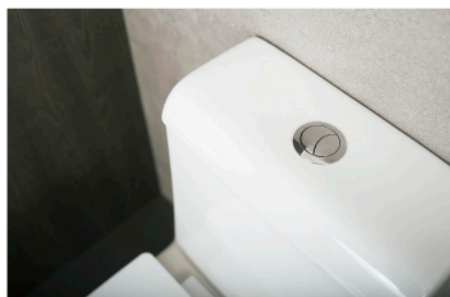

**BSN-43A**

TOILETS **SERIES**





**BSN-43A**

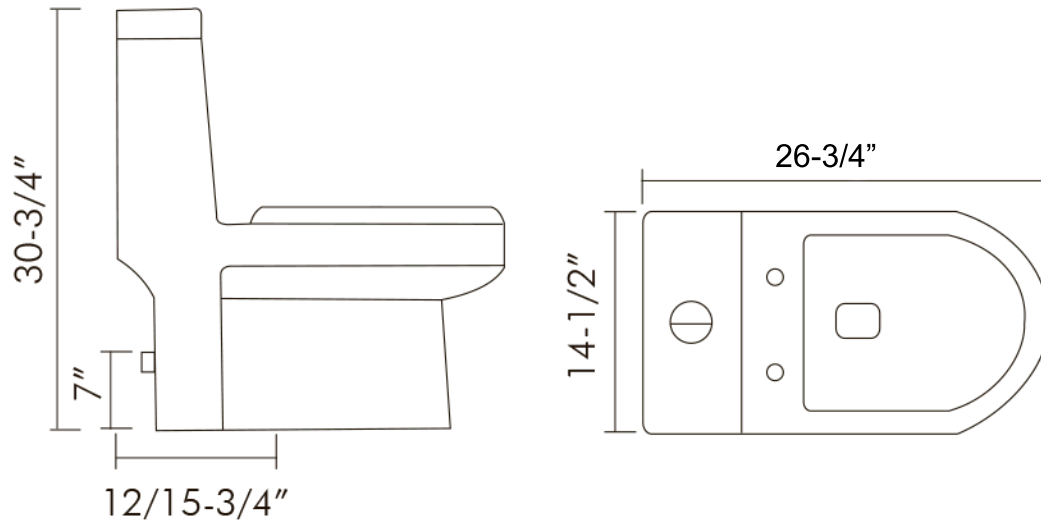

## FEATURES

- Ceramic material
- White gloss finish
- Chrome flush buttons
- Soft close seat included
- Dual flush
- 1.1 - 1.6 GPF
- One piece construction
- Floor mount





**TOILET BSN-43A**

|                      |                   |
|----------------------|-------------------|
| MODEL                | BSN-43A           |
| BOWL HEIGHT          | 16-1/2"           |
| BOWL SHAPE           | ROUND             |
| HEIGHT               | 30-3/4"           |
| LENGTH               | 26-3/4"           |
| WIDTH                | 14-1/2"           |
| CONFIGURATION        | ONE PIECE         |
| FLUSH TYPE           | DUAL FLUSH        |
| FLUSH VALVE SIZE     | 2"                |
| GALLONS PER FLUSH    | 1.1 - 1.6 GPF     |
| INSTALLATION TYPE    | S TRAP TO FLOOR   |
| MATERIAL (IN)        | CERAMIC           |
| COLOR                | WHITE             |
| SEAT INCLUDED        | PP SOFT CLOSE     |
| TRIP LEVER PLACEMENT | INSIDE WATER TANK |
| WATER AREA           | 7-3/8"X5-1/8"     |
| WATER EFFICIENT      | NORMAL            |
| WATERSENSE CERTIFIED | NO                |
| INCLUDED COMPONENTS  | SCREWS            |
| PRODUCT WEIGHT       | 116.9993 LB       |
| UPC APPROVED         | NO                |

For parts or sale requirements please contact our customer service department:



[CS@daxib.com](mailto:CS@daxib.com)



1 888 685 8236



01

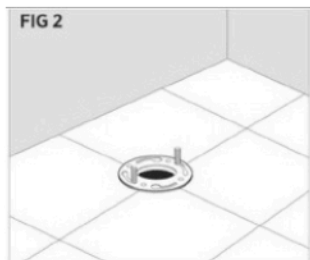

Install new floor bolts into floor flange. (Figure 2)

02

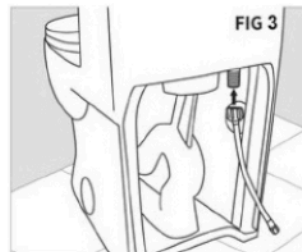

Attach flexible water supply line to the inlet of the fill valve and hand tighten only. At this point, DO NOT connect to the water shut-off valve. (Figure 3)

03

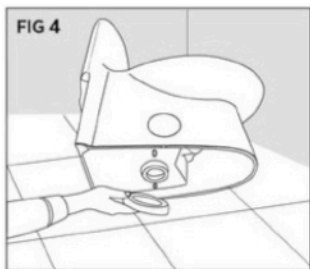

Place a new wax ring around the waste flange of toilet bowl. (Figure 4)

04



Lower the toilet onto the closet bolts, so the bolts project through mounting holes in base of toilet. (Figure 5) Using a rocking motion, press the bowl to position the toilet onto the flange.

05

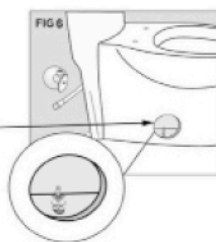
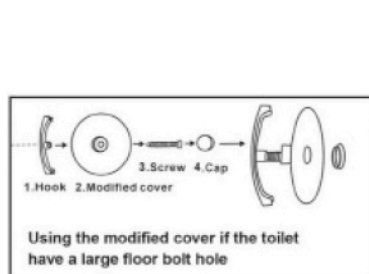

Install plastic cap washers, followed by metal washers and nuts onto the closet bolts. (Figure 6)

Tighten the bolts alternately until toilet is firmly seated on the floor.

**CAUTION: DO NOT OVERTIGHTEN NUTS, SEVERE DAMAGE MAY OCCUR**

Install plastic cap covers.

For parts or sale requirements please contact our customer service department:



CS@daxib.com



1 888 685 8236



**06**

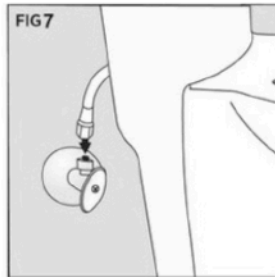

Connect the flexible water supply line (not included) to the shut-off valve. Tighten coupling nut securely (Figure 7).

**07**

### WATER SUPPLY

Turn on supply valve and allow tank to fill until float rises to shutoff position.

Check for leakage at fittings, tighten or correct as needed.

### **08** TWO PIECES TOILET INSTALLATION PROCEDURE

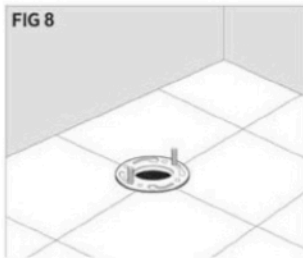

Install new closet bolts into closet flange. (Figure 8) You can pre-cut the closet bolts to the desired length to put on the bolt cap by doing the following: Temporarily install closet bolts and set the toilet and place the washers and nuts onto the bolts. Cut the closet bolts to the length and then turn the toilet upside down onto a soft surface to avoid scratches on the finish.

**09**



Place a new wax ring around the waste flange of toilet bowl. (Figure 9)

**10**



Lower the toilet onto the closet bolts, so the bolts project through mounting holes in base of toilet. (Figure 10) Using a rocking motion, press the bowl down to position the toilet onto the flange.

For parts or sale requirements please contact our customer service department:



CS@daxib.com



1 888 685 8236



11



Install plastic cap washers, followed by metal washers and nuts onto the closet-bolts. (Figure 11) Tighten the bolts alternately until toilet is firmly seated on the floor.

**CAUTION: DO NOT OVERTIGHTEN NUTS, SEVERE DAMAGE MAY OCCUR**

Install the flange bolt caps. (Figure 11)

12

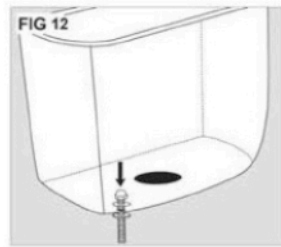

Insert tank bolts inside the tank. Use the metal and rubber washers supplied to create a seal. (Figure 12)

Install the metal nut and washers on the bolts under the tank. Tighten the nuts until the rubber washers in the tank create a proper and secure seal.

13



Attach the large rubber sealing gasket to the center drain hole under the tank. (Figure 13)

Gently place the tank on the bowl with the bolts protruding out underneath. Then tighten with metal oval washers and wing nuts, tighten enough that the tank sits flat on the bowl.

Make sure that the toilet tank is parallel to the wall and straight on the bowl.

**CAUTION: DO NOT OVERTIGHTEN NUTS, SEVERE DAMAGE MAY OCCUR**

14 **CONNECT WATER SUPPLY**

Connect water supply line (new or existing) between shutoff valve and tank inlet water fitting. Tighten coupling nuts securely. **NOTE: DO NOT OVERTIGHTEN**

Turn on supply valve and allow tank to fill until float rises to shutoff position.

Check for leakage at fittings, tighten or correct as needed.

For parts or sale requirements please contact our customer service department:



CS@daxib.com



1 888 685 8236