

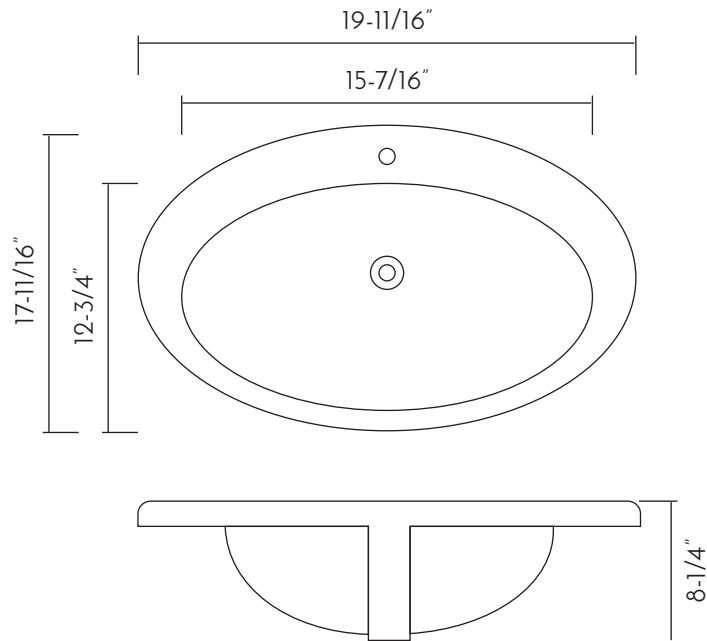

BSN-209-1



CERAMIC TOP MOUNT  
SINKS **SERIES**



## FEATURES

- Ceramic material
- Ivory gloss finish
- Overflow
- Overflow chrome ring included
- Pop up drain not included (available)
- Overmount installation
- Size W 19-11/16" x H 17-11/16" x D 8-1/4"





01

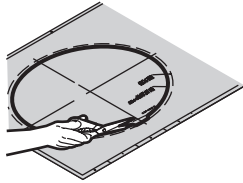

Cut along the inside line of the supplied template.

02

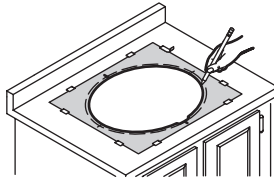

Trace the cutout.

03

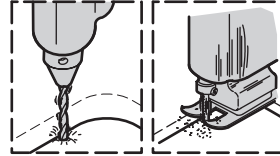

Drill a pilot hole and cut the countertop opening along the inside line.

04

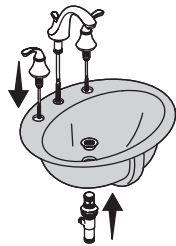

Install the faucet and rain.

05

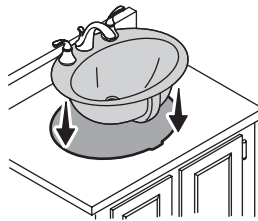

Verify de fit. Adjust the cutout if your needed.

06

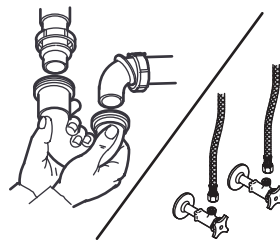

Complete the faucet and rain connections.

07

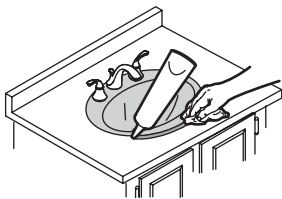

Apply sealant and wipe away any excess. Fill avoids and allow to dry.

08

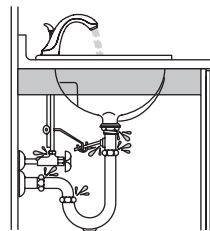

Run water and check for leaks.

For parts or sale requirements please contact our customer service department:



CS@daxib.com



1 888 685 8236