

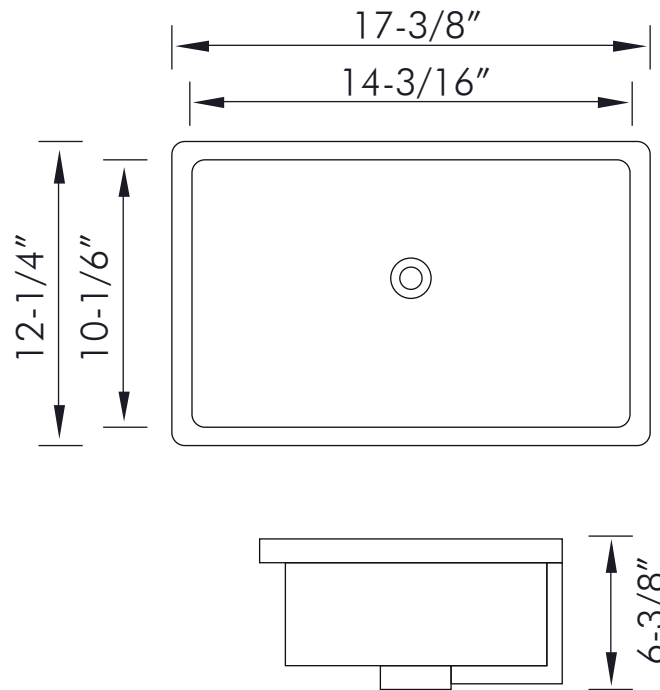

BSN-1812



CERAMIC UNDERMOUNT SINKS **SERIES**



FEATURES

- Ceramic material
- White gloss finish
- Overflow
- Overflow chrome ring included
- Pop up drain not included (available)
- Undermount installation
- Size W $17\text{-}3/8''$ x H $12\text{-}1/4''$ x D $6\text{-}3/8''$





01

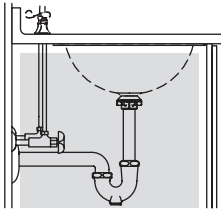

Verify fit or relocate plumbing.
If possible, pre-install the drain
to the lavatory.

02



Clean the underside of the
countertop and the rim of
the lavatory.

03

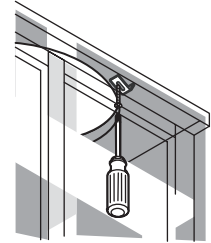

Loosely install the clips.

04

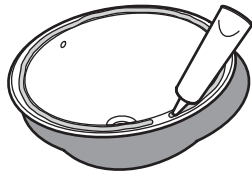

Generously apply 100% silicone
sealant. Do not use adhesives
or adhesive sealants.

05

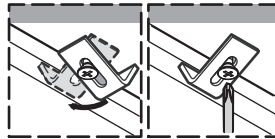

While lifting the lavatory,
rotate and tighten clips evenly.
Use anchors and fasteners
provided with countertop.

06



Wipe away excess sealant.
Essuyer l'excès de mastic.
Limpie el exceso de sellador.

07

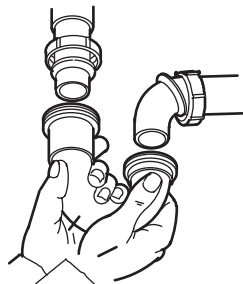

Complete faucet installation.
Connect drain.

08

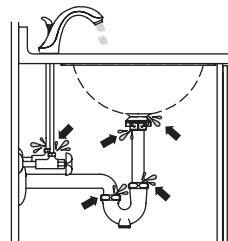

Run water into the lavatory
and check for leaks.