

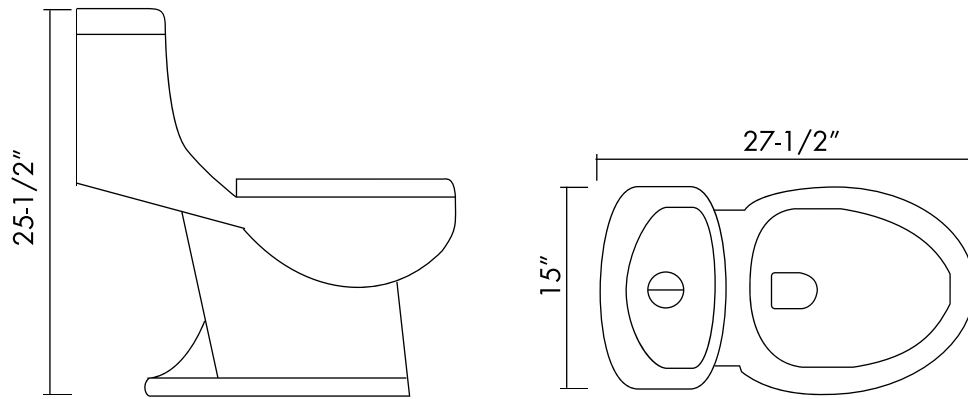

BSN-11

TOILETS **SERIES**





FEATURES

- Ceramic material
- White gloss finish
- Chrome flush buttons
- Soft close seat included
- Dual flush
- 1.06 - 1.6 GPF
- One piece construction
- Floor mount





TOILET BSN-11

MODEL	BSN-11
BOWL HEIGHT	15-3/4"
BOWL SHAPE	ROUND
HEIGHT	25-1/2"
LENGTH	27-1/2"
WIDTH	15"
CONFIGURATION	ONE PIECE
FLUSH TYPE	DUAL FLUSH
FLUSH VALVE SIZE	2"
GALLONS PER FLUSH	1.06 - 1.6 GPF
INSTALLATION TYPE	S TRAP TO FLOOR
MATERIAL	CERAMIC
COLOR	WHITE
SEAT INCLUDED	PP SOFT CLOSE
TRIP LEVER PLACEMENT	INSIDE WATER TANK
WATER EFFICIENT	NORMAL
WATERSENSE CERTIFIED	YES
INCLUDED COMPONENTS	SCREWS
UPC APPROVED	YES



For parts or sale requirements please contact our customer service department:



CS@daxib.com



1 888 685 8236



01

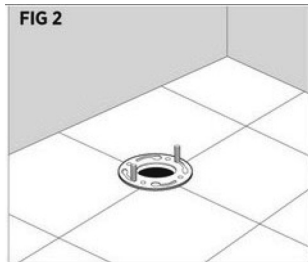

Install new floor bolts into floor flange. (Figure 2)

02

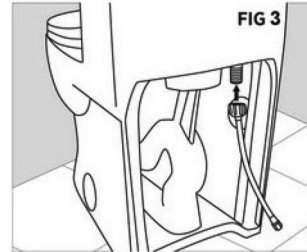

Attach flexible water supply line to the inlet of the fill valve and hand tighten only. At this point, **DO NOT** connect to the water shut-off valve. (Figure 3)

03

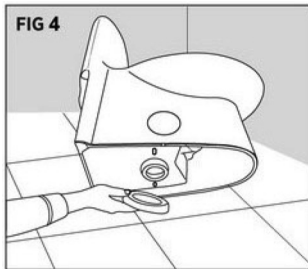

Place a new wax ring around the waste flange of toilet bowl. (Figure 4)

04

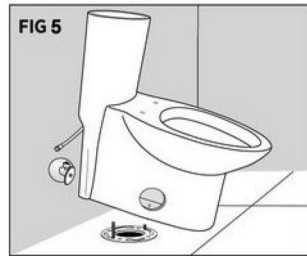

Lower the toilet onto the closet bolts, so the bolts project through mounting holes in base of toilet. (Figure 5) Using a rocking motion, press the bowl to position the toilet onto de flange.

05

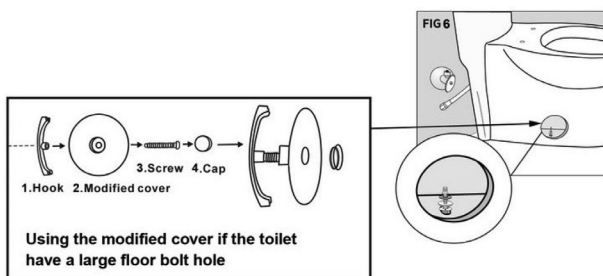

Install plastic cap washers, followed by metal washers and nuts onto the closet bolts. (Figure 6)

Tighten the bolts alternately until toilet is firmly seated on the floor.

CAUTION: DO NOT OVERTIGHTEN NUTS, SEVERE DAMAGE MAY OCCUR

Install plastic cap covers.

For parts or sale requirements please contact our customer service department:



CS@daxib.com



1 888 685 8236





06

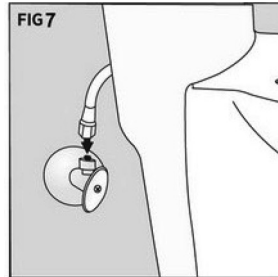

Connect the flexible water supply line (not included) to the shut-off valve. Tighten coupling nut securely (Figure 7).

07

WATER SUPPLY

Turn on supply valve and allow tank to fill until float rises to shutoff position.

Check for leakage at fittings, tighten or correct as needed.

08 TWO PIECES TOILET INSTALLATION PROCEDURE

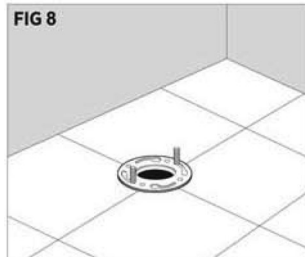

Install new closet bolts into closet flange. (Figure 8) You can pre-cut the closet bolts to the desired length to put on the bolt cap by doing the following: Temporarily install closet bolts and set the toilet and place the washers and nuts onto the bolts. Cut the closet bolts to the length and then turn the toilet upside down onto a soft surface to avoid scratches on the finish.

09



Place a new wax ring around the waste flange of toilet bowl. (Figure 9)

10



Lower the toilet onto the closet bolts, so the bolts project through mounting holes in base of toilet. (Figure 10) Using a rocking motion, press the bowl down to position the toilet onto the flange.

For parts or sale requirements please contact our customer service department:



CS@daxib.com



1 888 685 8236





11



Install plastic cap washers, followed by metal washers and nuts onto the closet-bolts. (Figure 11) Tighten the bolts alternately until toilet is firmly seated on the floor.

CAUTION: DO NOT OVERTIGHTEN NUTS, SEVERE DAMAGE MAY OCCUR

Install the flange bolt caps. (Figure 11)

12

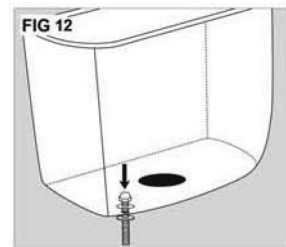

Insert tank bolts inside the tank. Use the metal and rubber washers supplied to create a seal. (Figure 12)

Install the metal nut and washers on the bolts under the tank. Tighten the nuts until the rubber washers in the tank create a proper and secure seal.

13



Attach the large rubber sealing gasket to the center drain hole under the tank. (Figure 13)

Gently place the tank on the bowl with the bolts protruding out underneath. Then tighten with metal oval washers and wing nuts, tighten enough that the tank sits flat on the bowl.

Make sure that the toilet tank is parallel to the wall and straight on the bowl.

CAUTION: DO NOT OVERTIGHTEN NUTS, SEVERE DAMAGE MAY OCCUR

14 CONNET WATER SUPPLY

Connect water supply line (new or existing) between shutoff valve and tank inlet water fitting. Tighten coupling nuts securely. **NOTE: DO NOT OVERTIGHTEN**

Turn on supply valve and allow tank to fill until float rises to shutoff position.

Check for leakage at fittings, tighten or correct as needed.

For parts or sale requirements please contact our customer service department:



CS@daxib.com



1 888 685 8236

