



2290156



TOILET PAPER HOLDERS **SERIES**
BY COSMIC



BY
COSMIC

www.daxib.com



MEASUREMENTS

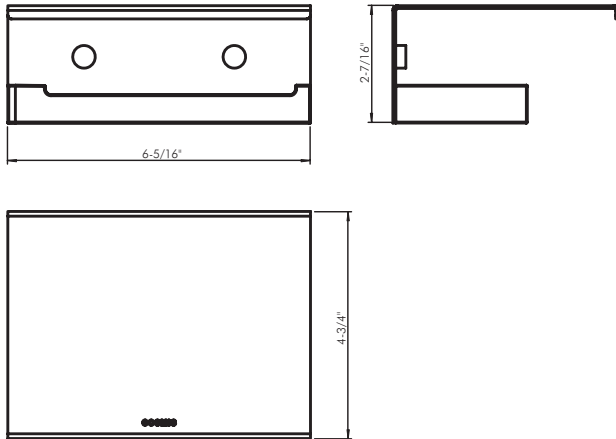

DIMENSIONS

6-5/16" x 2-7/16" x 4-3/4"

INSTALLATION GUIDE

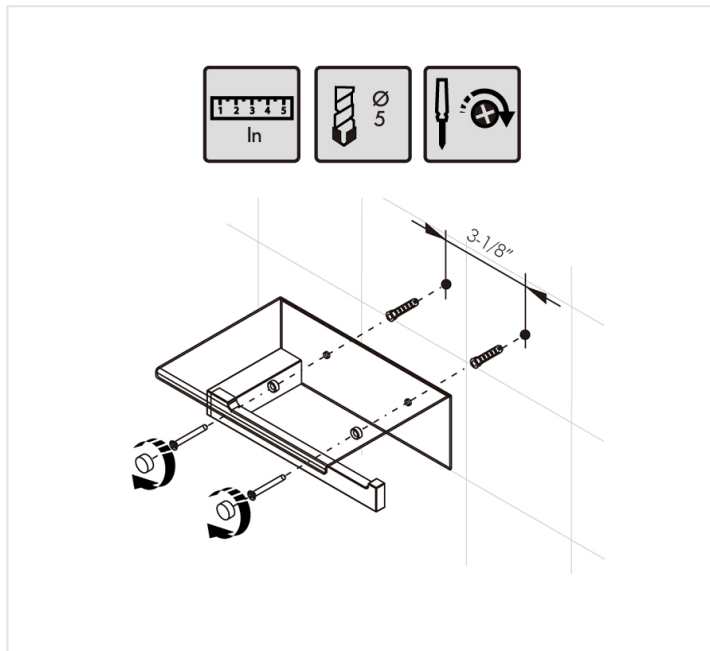

For parts or sale requirements
please contact our customer service department:



CS@daxib.com



1 888 685 8236

BY
COSMIC