

LUKAS COT BED

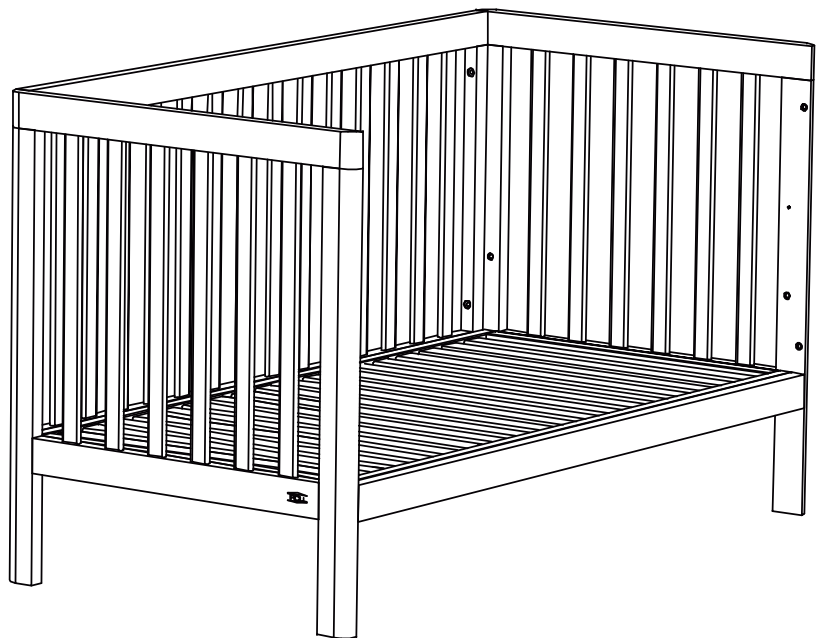

TROLL NURSERY

Part list

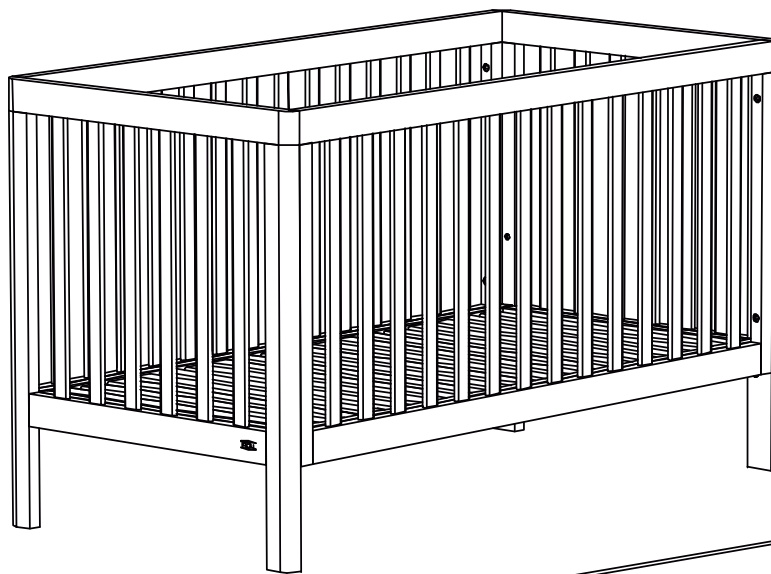
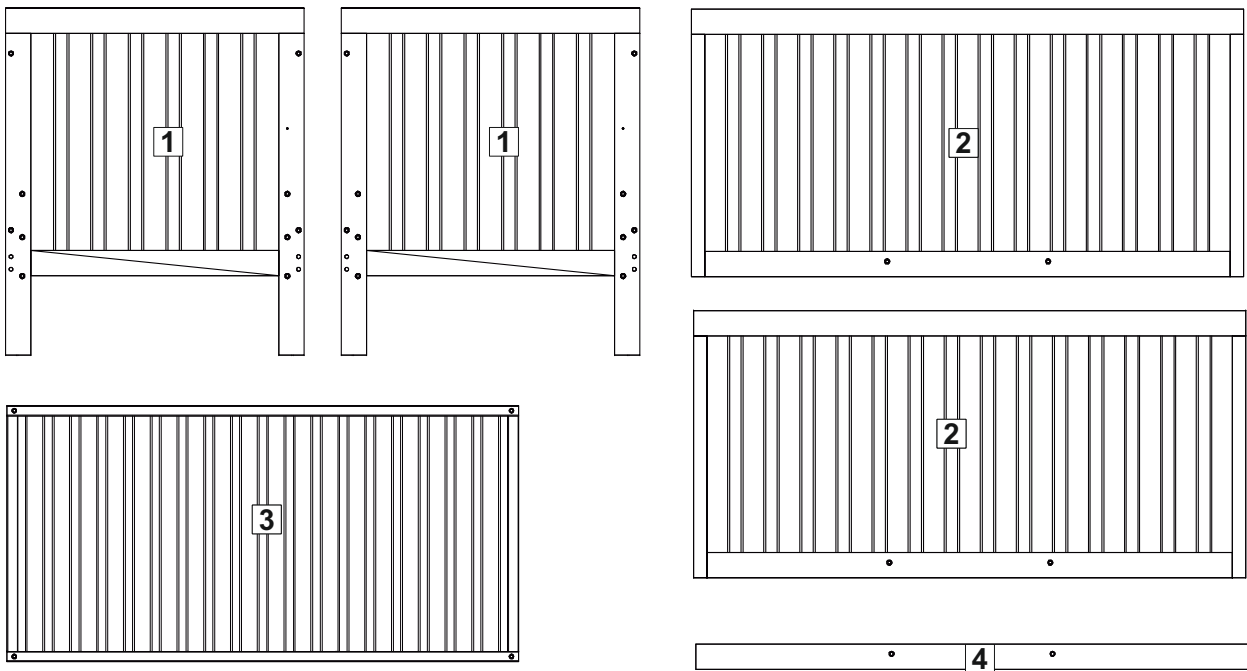

Fittings list

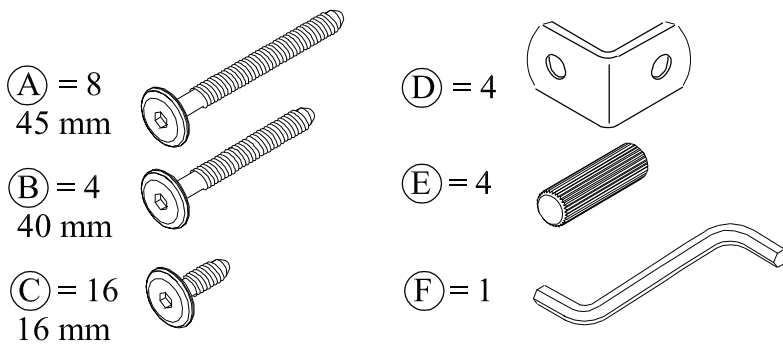

Assembly - Cot

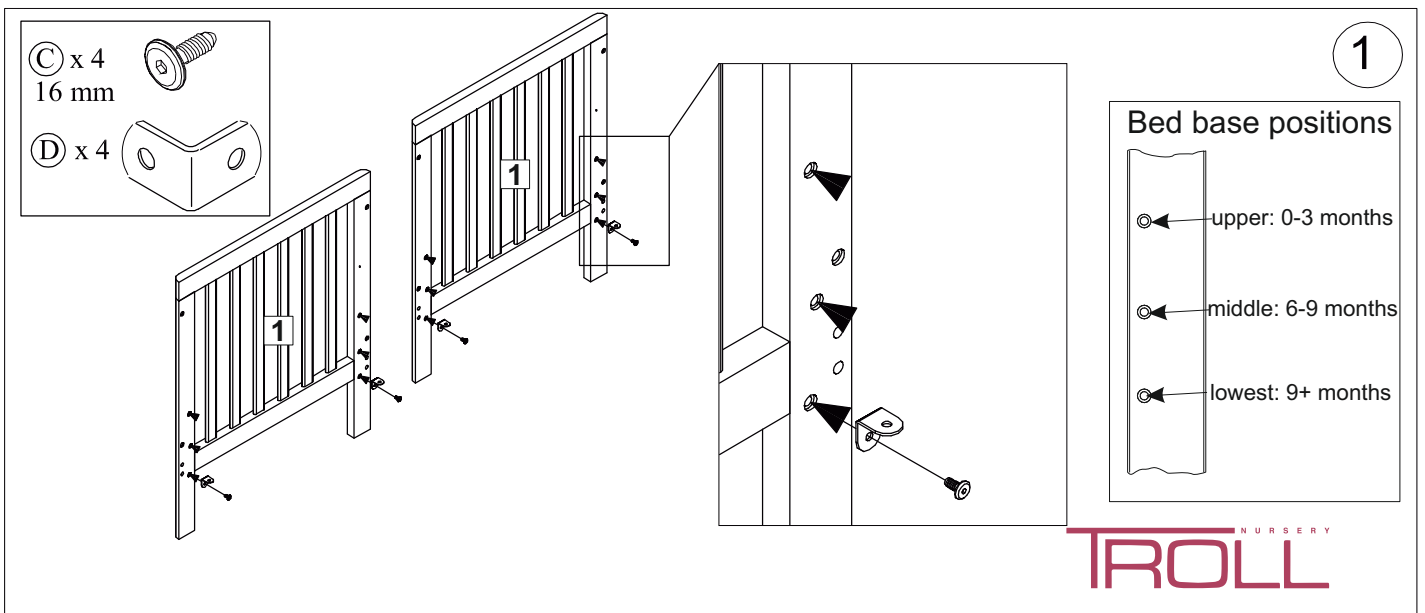

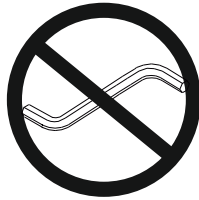

Ⓒ x 4
16 mm



Ⓐ x 8
45 mm

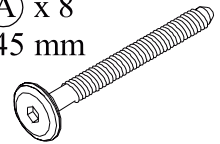

2

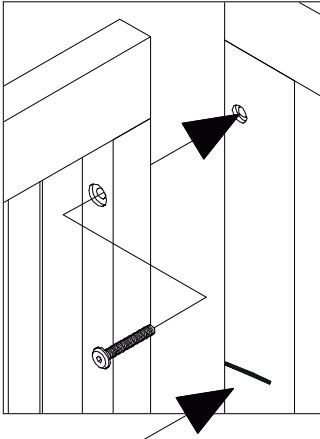

WARNING! The top of the mattress surface must not be higher than this mark!

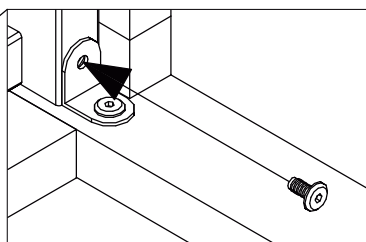
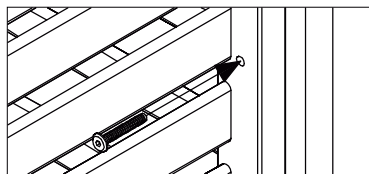
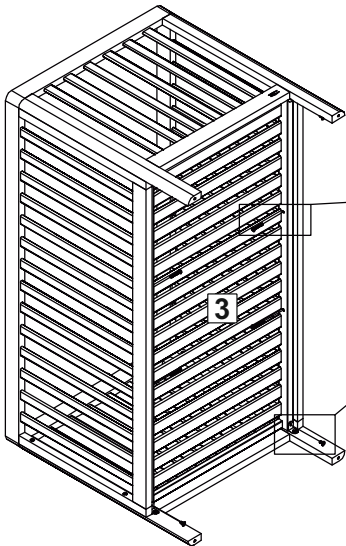
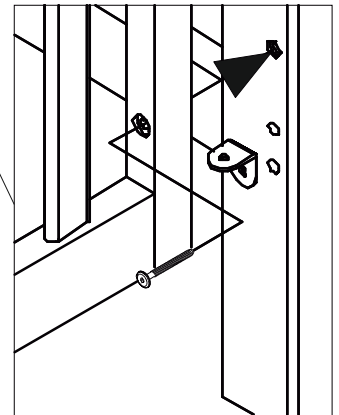
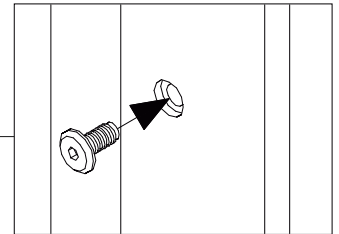
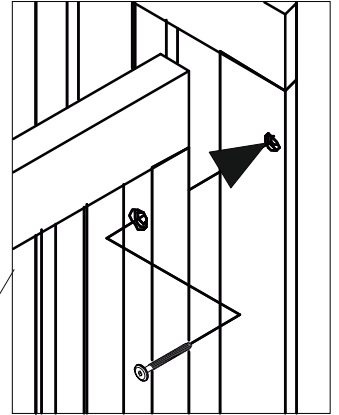
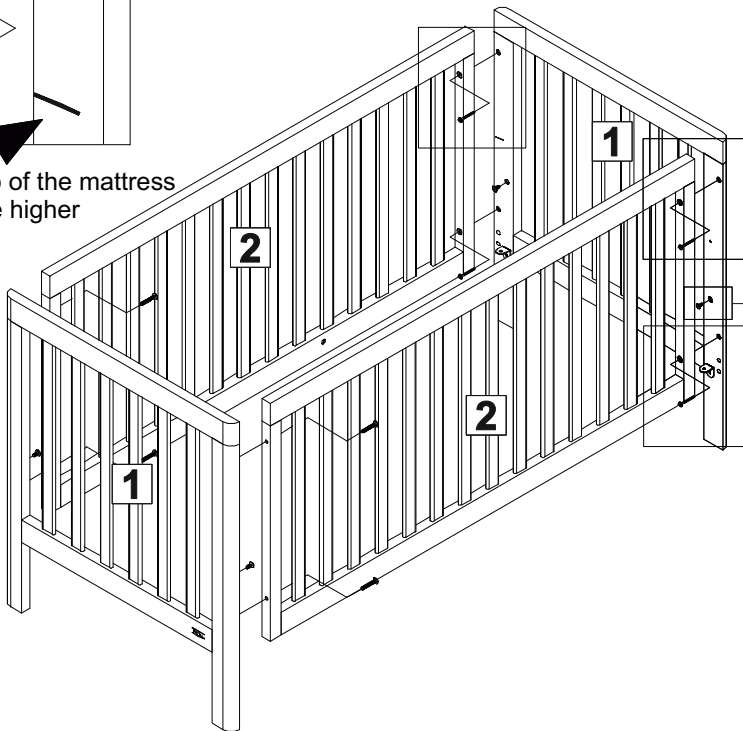

3

Ⓑ x 4
40 mm

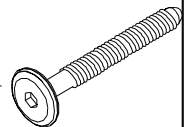

Ⓕ = 1

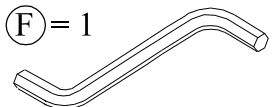

Tighten all bolts

Ⓒ x 4
16 mm

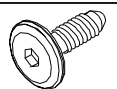

Assembly - Bed

1

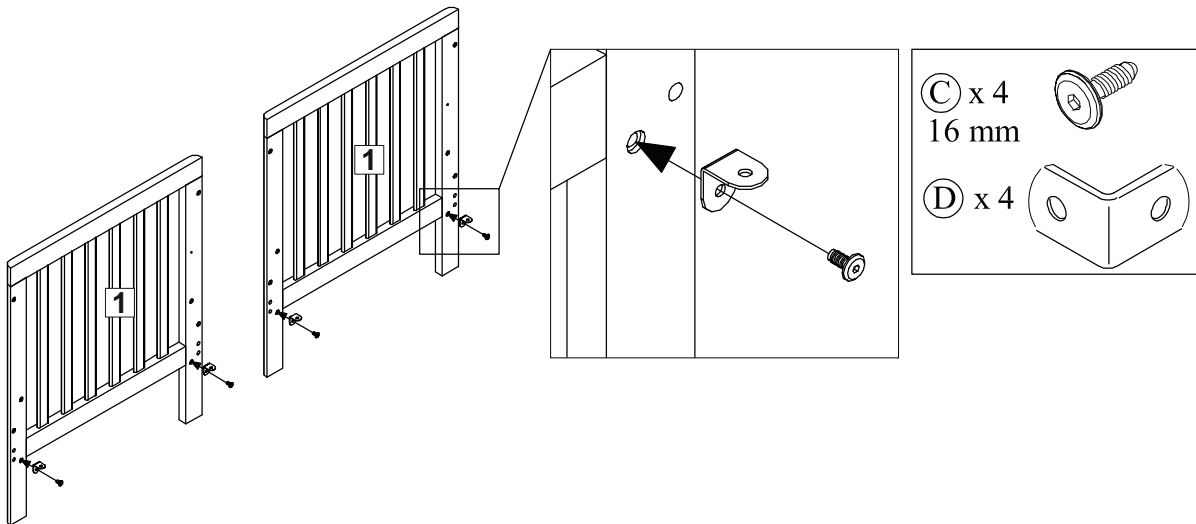

2

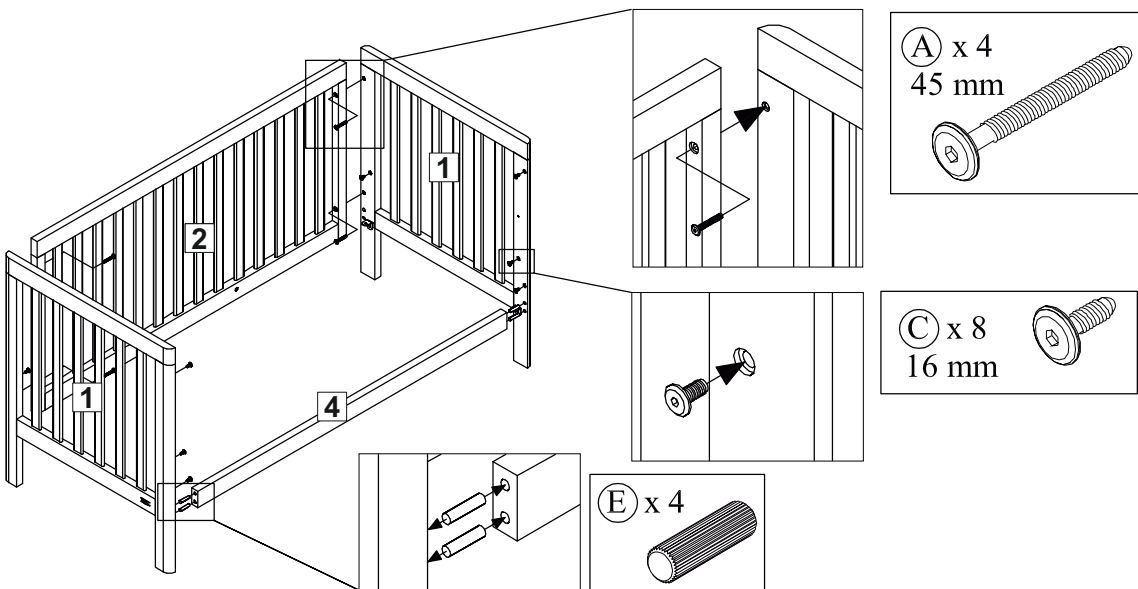

3

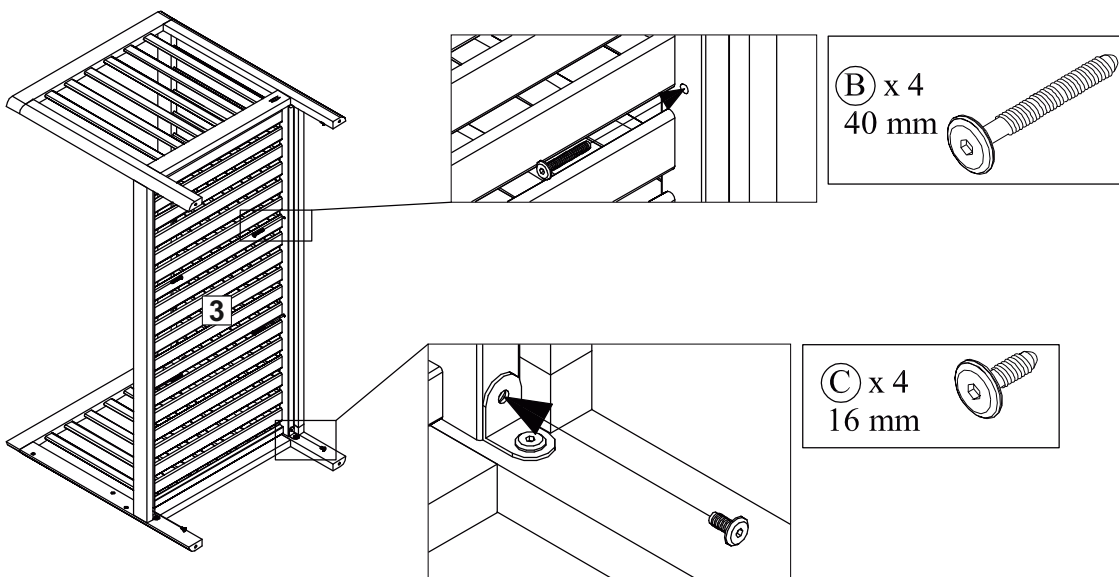

IMPORTANT RETAIN FOR FUTURE REFERENCE READ CAREFULLY

Your child's safety is your responsibility

Furniture can be dangerous if incorrectly installed, assembly should be carried out by a competent person

Follow the instructions in detail to ensure the safety features of the cot are not compromised

Take care when handling or moving furniture. Careless handling can cause damage

Keep children away during assembly as pack contains small parts which may present a choking hazard

Remove all parts from packaging and check against the parts list

Do not discard any packaging until you are sure you have all parts and the fittings pack

Assembly of the furniture will be easier with 2 people

WARNING: Be aware of the risk of open fire and other sources of strong heat, such as electric bar fires, gas fires, etc. in the near vicinity of the cot

WARNING. Do not place this child's bed near heat sources, windows and other furniture

WARNING: Do not use the cot if any part is broken, torn or missing and use only spare parts approved by the manufacturer

WARNING: Do not leave anything in the cot or place the cot close to another product, which could provide a foothold or present a danger of suffocation or strangulation, e.g. strings, blind/curtain cords

WARNING: Do not use more than one mattress in the cot

The lowest bed base position is the safest. To prevent falls the mattress base of this cot should be adjusted to the lowest position before the child can sit up.

The thickness of the mattress shall be such that the internal height (surface of the mattress to the upper edge of the cot frame) is at least 500 mm in the lowest position of the cot base and at least 200mm in the highest position of the cot base. There is a mark on the inside of the cot which shows the maximum thickness of the mattress to be used with the cot

The cot bed is designed to be used with a mattress measuring 1400mm long by 700mm wide and 100mm tall

The minimum size of the mattress to be used with the cot is 1370mm long by 670mm wide. There shall be no gap more than 30 mm between the mattress and the sides end ends in any position of the mattress.

To prevent injury from falls; when the child is able to climb out of the cot, the cot shall no longer be used by the child.

When converted into a toddler bed the product can be used from 18 months to 4 years

Children are likely to play, bounce, jump and climb on beds, therefore the child's bed should not be placed too close to other furniture or windows, blind cords, curtain pulls or other strings or cords, and should be placed either tight to any wall or have a gap of 300 mm between the wall and the side of the bed

All assembly fittings should always be tightened properly and fittings should be checked regularly and retightened as necessary

The bed is designed to be dismantled for transportation and storage

Your furniture may be cleaned by wiping down with a damp cloth and dried with a soft, clean cloth. Do not use abrasives, bleach, alcohol or ammonia based household polishes.

The Cot bed is made to conform to safety regulations: BS EN 716-1&2: 2017 and BS 8509: 2008+A1: 2011

For questions and advice regarding this product please contact CuddleCo

Customer services at: customerservice@cuddleco.co.uk or go to www.cuddleco.co.uk