

ANCONA

Gala Dual XL Towel Warmer



User Manual & Installation Instructions

IMPORTANT SAFETY INSTRUCTIONS
Carefully read the important information
regarding installation, safety and maintenance.
Keep these instructions for future reference.

MAAN5366-02
2018-06-04

Required Tools

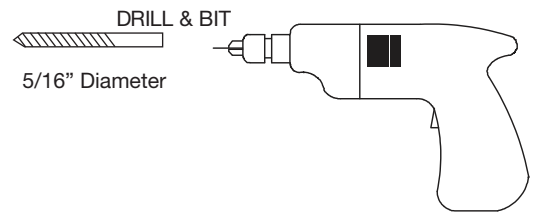
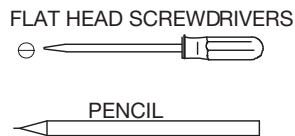
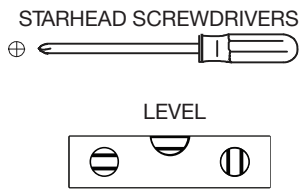

Electrical requirements: 120V, 120W, 60Hz, 1.0A. MUST HAVE A GROUND CONNECTION. Should be protected by a 15 amp GFI circuit breaker or equal.
READ ALL INSTRUCTIONS IN THE MANUAL BEFORE INSTALLING THIS TOWEL WARMER.

Before You Begin

Unpack the towel warmer carefully to avoid any damage or loss of any part. When opening the box, care should be taken to not discard packet of mounting screws. It is your responsibility to immediately inspect for any damage. Shipping damage should be reported immediately to your place of purchase.

Follow instructions to make sure your towel warmer is properly installed. **FAILURE TO FOLLOW THESE STEPS COULD RESULT IN HAZARDOUS CONDITIONS.**

To avoid possible fire hazard, the Towel Warmer must be mounted as intended. **MOUNT THIS UNIT AS SHOWN IN THESE INSTRUCTIONS.**

The towel warmer must be used in accordance with any prevailing code and relevant electrical wiring rules and regulations, in particular regulations that cover the use of products and accessories in damp situations such as showers, laundries and other areas with fixed water containers.

- Towel Warmer must be mounted vertical with cord in position as shown. No other position is safe or recommended.
- To provide continued protection against the risk of electrical shock, connect to properly grounded outlet only.
- Towel Warmer must be securely mounted to the wall. When possible, the Towel Warmer should be attached to adequate blocking or framing. Installations where blocking or framing is not available, must use appropriate wall anchors for mounting directly to sheetrock.



CAUTION:

1. Approved for domestic use only. Do not use outdoors.
2. Install in accordance with national and local codes.
3. Do not install in the shower, sauna or any wet locations.
4. Make sure towel warmer is properly secured to the wall before use.

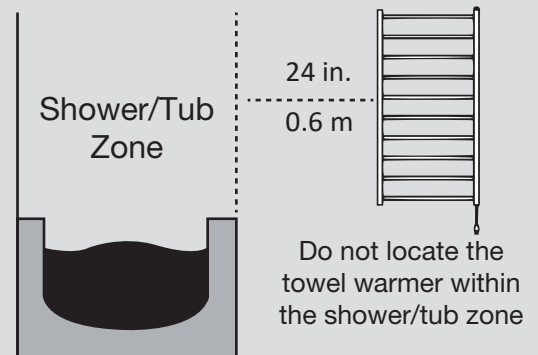

For illustrative purposes only



- Failure to follow the installation instructions may lead to overheating and malfunction.
- Any repairs that involve opening the Towel Warmer must be carried out by manufacturer or their representative.
- Please contact your supplier in the event of any problem or if repair is needed.

Product Dimensions

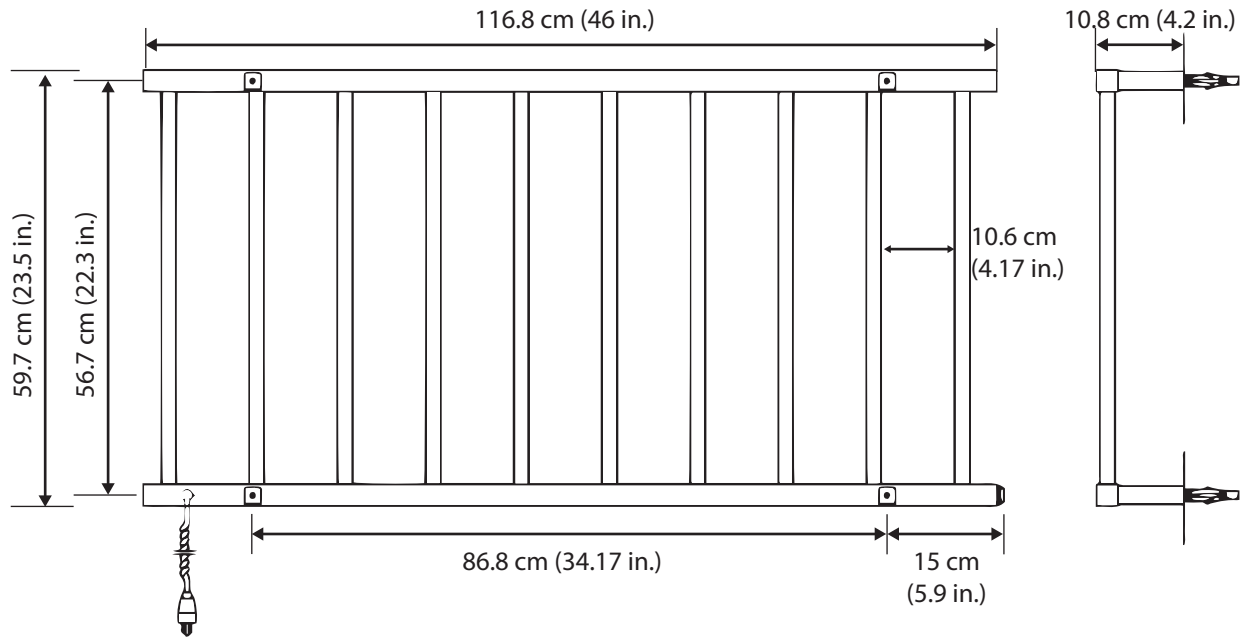

Parts for Plug-In Wall Mount Installation

• x 4
M5x5

▬ x 4

⊙ x 4

• x 4
M5x10

▬ x 4
ST4.2x40

└ x 2

▬ x 4

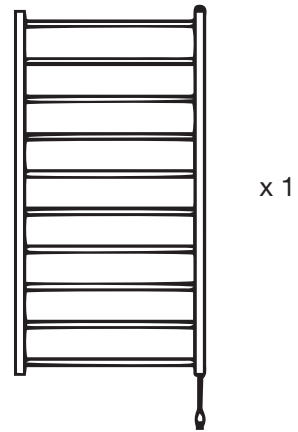

Plug-In Installation

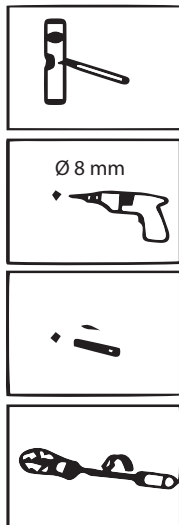
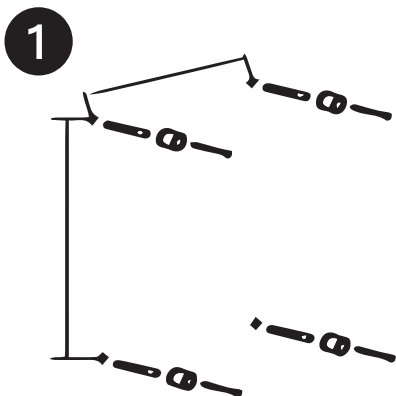

2

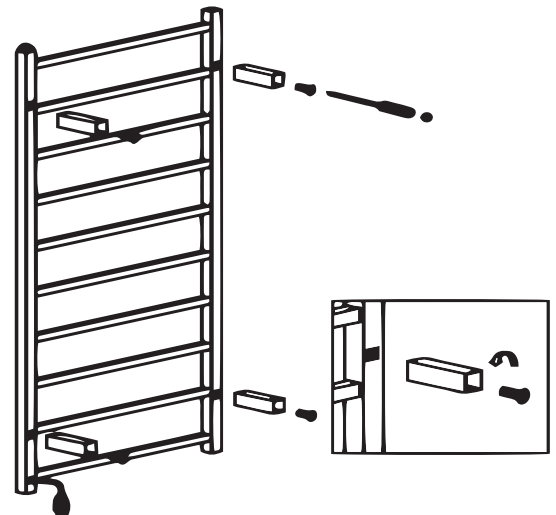

Plug-In Installation

3

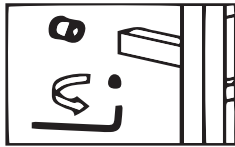
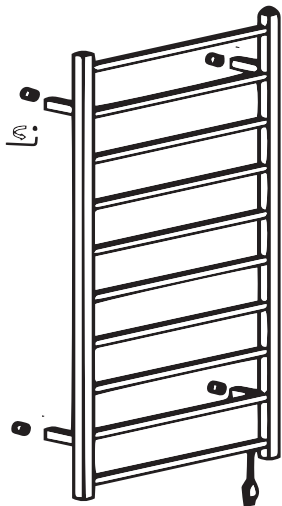

4

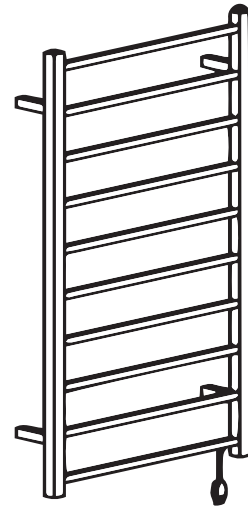

Parts for Hardwire Wall Mount Installation

• x 4
M5x5

▬ x 4

▬ x 1

⊖ x 4

• x 4
M5x10

▬ x 4
ST4.2x40

▬ x 1

└ x 2

• x 1
M5x15

▬ x 4

▬ x 2

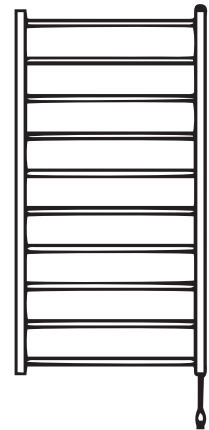

x 1

Hardwire Installation

1

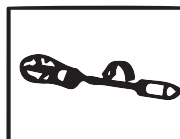
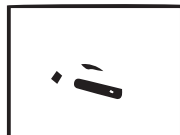
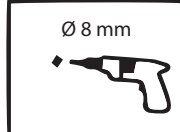
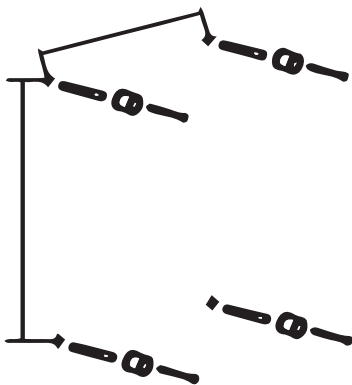

2

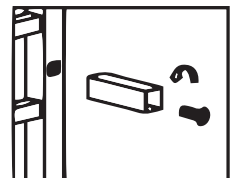
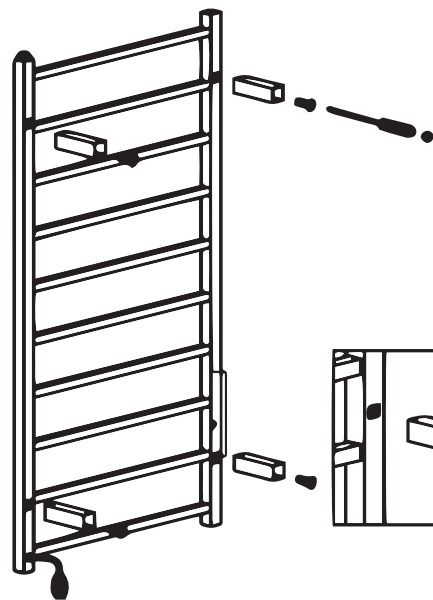

Hardwire Installation

3

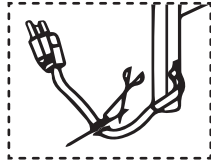

4

All electrical connections in the junction box must be performed by a fully qualified electrician.

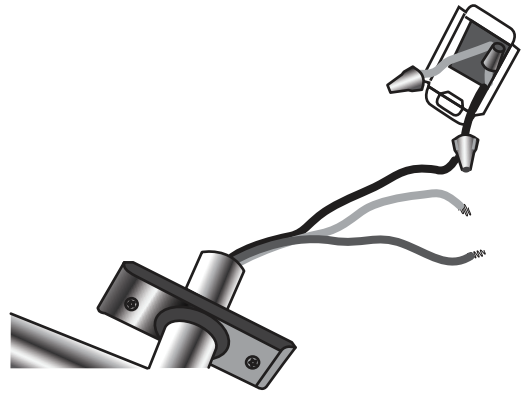

5

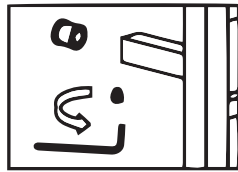
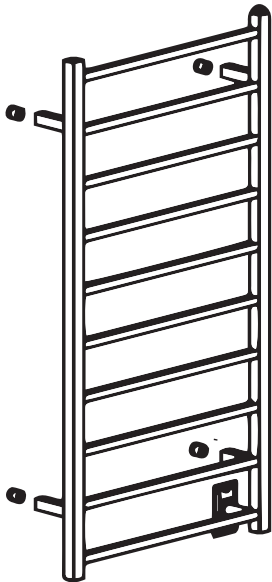

6

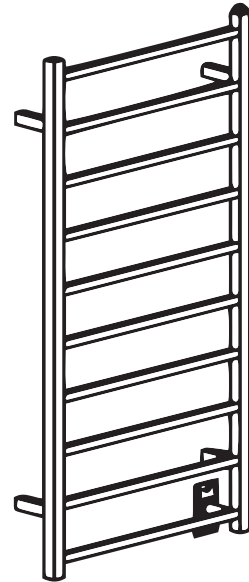

Operation and Maintenance Instructions

- After installation, connect the electric power and turn on the switch. The indicator light will show red and the towel warmer will start to work.
- Turn off the switch when the towel warmer is not in use. The indicator light will turn dark and the towel warmer will stop working.
- When cold, clean the towel warmer with a soft dry towel. Do not clean with abrasive cleaning powder.
- Unplug the unit if not in use for a long period of time.



CAUTION - Overlapping towels may increase towel warmer temperatures.

- **PROPERLY HANG TOWELS.**
- **DO NOT OVERLAP TOWELS.**

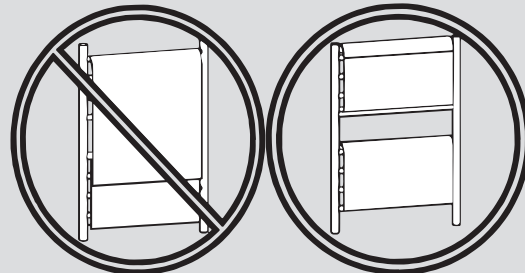

NOTE: There is no limit to how long a towel warmer can stay on. However, in order to conserve the life expectancy of our Ancona towel warmer, we recommend that the unit be on consecutively no more than two to three hours at a time.



- According to the National Electrical Code, all electrical work must be carried out by authorized licensed professionals. For your safety, please ensure you adhere to these regulations.
- Please ensure the power cord does not come in contact with the rail during operation.
- The power code is the means of disconnecting the unit from the main power outlet.
- The Towel Warmer will be hot. Please exercise caution if the Towel Warmer is accessible to children or the elderly. Please ensure that children are supervised at all times in the vicinity of the Towel Warmer and warn them that it is a hot surface that can cause burns.



HIGH OPERATING TEMPERATURE!

- Towel warmers are designed for heating towels and bathrobes and should not be used for other purposes. The manufacturer or reseller assumes no liability if the device is used in combination with equipment or accessories not sold by the manufacturer.
- This towel warmer is to be only used with fabrics that are water washable. Towels which contain soap or detergent residue may appear to have scorch marks; however, this is simply discoloration of the residue in the towels themselves. The unit does not reach a temperature sufficient to scorch towels.
- Never stand, sit or climb on the unit.
- This towel warmer operates at high temperatures that can cause burns. Do not touch surfaces of the towel warmer while the warmer is in operation. The unit is designed to warm up towel and may become very hot.
- Do not allow unsupervised children in the vicinity of the towel warmer; and warn children of hot surfaces. An adult must supervise when the device is used by or near children.
- Unplug the unit with a dry hand and ensure that the electrical circuit breaker is off the main panel before wiring, carrying out a repair or servicing your heated towel warmer.
- Do not place your towel warmer inside a shower, sauna or plunge into the water.
- To ensure continued protection against risk of electric shock, plug the unit into a properly grounded outlet.
- Approved for domestic use only. Do not use outdoors.

Information: service@anconahome.com or 1-800-350-4562