



# NOAH

## convertible crib

### ASSEMBLY INSTRUCTIONS



**assembling**  
2 people



**time**  
approximately 1 hour



**tools**  
philips screwdriver, rubber hammer

[www.simplynursery.com](http://www.simplynursery.com)

Manufacturer Móveis Caftor Ltda. Rio Negrinho/SC - Brazil - 89295-000.

Distributed in the USA by: SIMPLY NURSERY, LLC. Orlando/Florida - 32819 - United States - 1-888-343-0730

**⚠ CAUTION: ANY MATTRESS USED IN THIS CRIB SHALL BE AT LEAST 27 ¼ BY 51 ⅝ IN. WITH A THICKNESS NOT EXCEEDING 6 IN. THE DIMENSIONS OF THE MATTRES SHALL BE TAKEN FROM SEAM TO SEAM OR EDGE TO EDGE WHERE APPROPRIATE.**

**⚠ WARNING!**

Infants can suffocate in gaps between crib sides and mattress that is too small.

**⚠ WARNING!**

Infants can suffocate on soft bedding. Never add a pillow or comforter. Never place additional padding under an infant

**⚠ WARNING:** Failure to follow these warnings and the assembly instructions could result in serious injury or death

**⚠ WARNING:** Never use plastic shipping bags or other plastic film as mattress covers because they can cause suffocation.

**⚠ WARNING:** Read all instructions before assembling crib. Keep instructions for future use.

- To reduce the risk of SIDS, pediatricians recommend healthy infants be placed on their backs to sleep, unless otherwise advised by your physician.

**⚠ Strangulation Hazard:**

- Strings can cause strangulation! Do not place items with a string around a child's neck, such as hood strings or pacifier cords. Do not suspend strings over a crib or attach strings to toys.
- To help prevent strangulation tighten all fasteners. A child can trap parts of the body or clothing on loose fasteners.
- DO NOT place crib near window where cords from blinds or drapes may strangle a child.

**⚠ Fall Hazard:**

- When child is able to pull to a standing position, set mattress to lowest position and remove bumper pads, large toys and other objects that could serve as steps for climbing out.
- Stop using crib when child begins to climb out or reaches the height of 35 in (89 cm).
- Check this product for damaged hardware, loose joints, loose bolts or other fasteners, missing parts, or sharp edges, before and after assembly and frequently during use. Securely tighten loose bolts and other fasteners. DO NOT use crib if any parts are missing, damaged or broken. Contact Simply Nursery, LLC for replacement parts and instructional literature if needed. DO NOT substitute parts.

**⚠ WARNING:** Follow warnings on all products in a crib.

- DO NOT use this crib if the instructions cannot be strictly followed.
- DO NOT use a water mattress with this crib.
- If refinishing, use a non-toxic finish specified for children's product.
- Do not place this crib near a window or a patio door where a child could reach the cord of a blind or curtain and be strangled.
- Parents should ensure a safe environment for the child by checking regularly, before placing the child in the product, that every component is properly and securely in place.

## **Care and Cleaning**

To remove accumulated dust of your wood product use a soft, lint-free cloth. For a deeper cleaning use a soft, lint-free cloth which has been dampened on a solution of neutral detergent and warm water. Do not use oily products, abrasives, ammonia or other aggressive products of cleaning.

## **How to prevent your wood furniture from warping, cracking or drying out:**

- Keep moderate temperatures (70°F - 72°F) and humidity around 50% - 55% in your home set.
- Ensure your humidifier is working properly.
- Avoid recurrent and/or sudden variation in humidity.
- Place your wood furniture away from heat sources, for example, but not limited to fireplaces or radiators.
- Keep your furniture away from direct sunlight.
- Use a dehumidifier during rainy seasons to remove excess moisture from the air.

# NOAH CONVERTIBLE CRIB

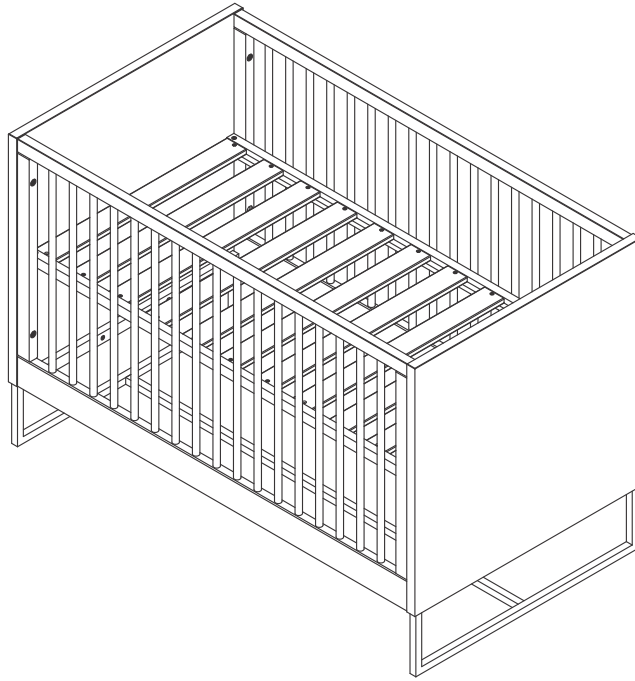

## Parts

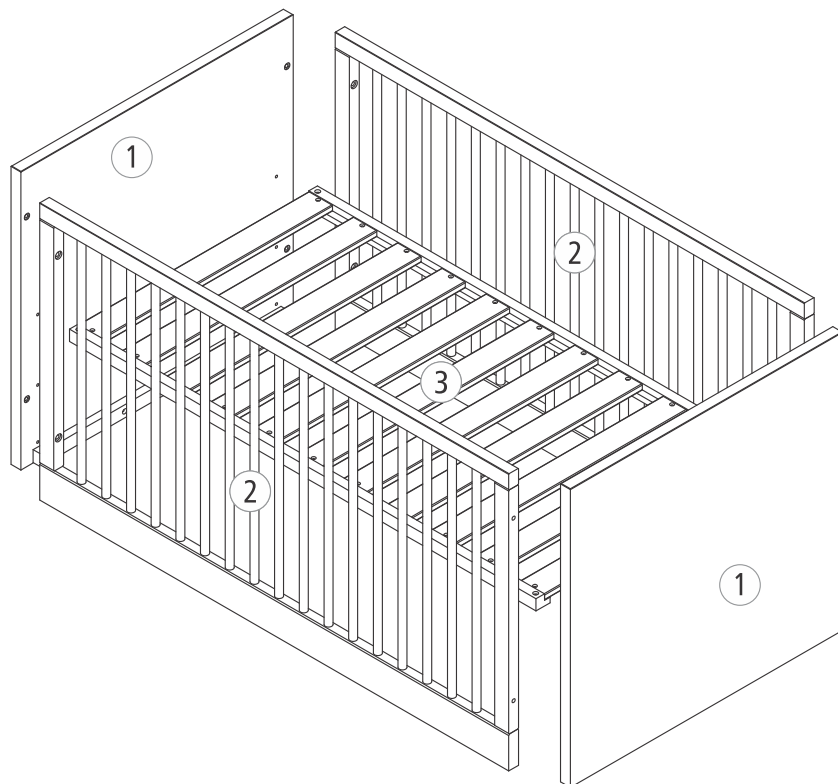

# Material



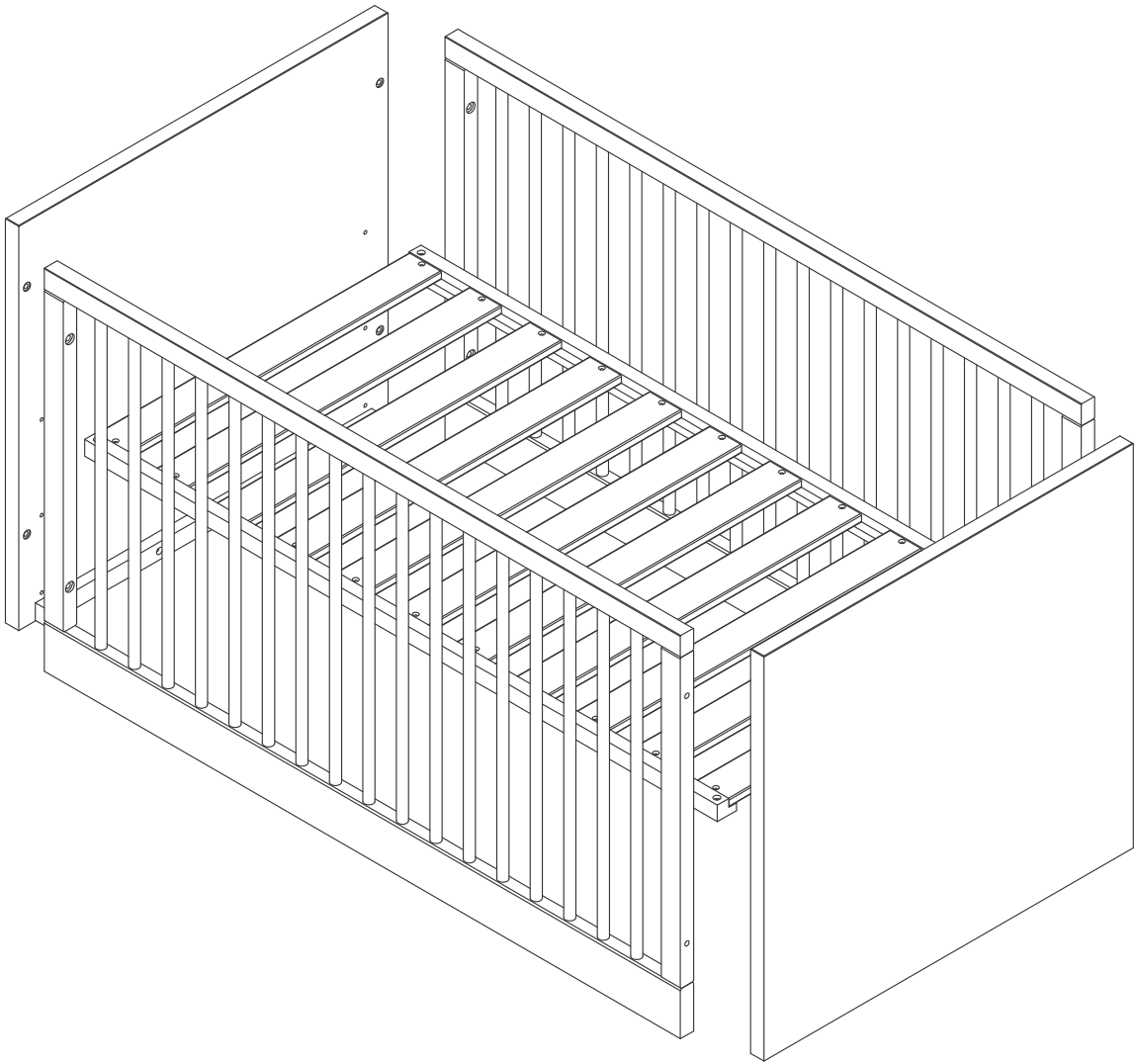





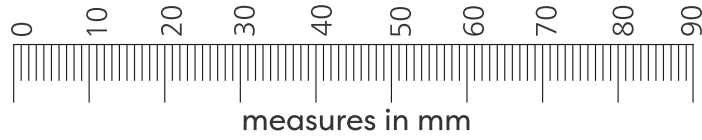

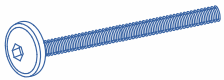

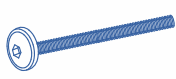
 pieces of wood

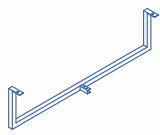

# Hardware Set

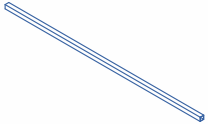
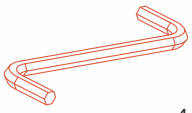
Use the ruler below to measure the hardware:



a	 1/4 x 60 mm	8 pcs	h	 Ø 10 mm	4 pcs
b	 1/4 x 40 mm	4 pcs	i	 Ø 8 mm	4 pcs
c		4 pcs	j	 Ø 17 mm	8 pcs
d		2 pcs	k	 Ø 13,5 mm	12 pcs
e		1 pcs	l	 4 mm	1 pc
f		4 pcs	m	 4 mm	1 pc
g		4 pcs	n		4 pcs

1

2

3

4

5

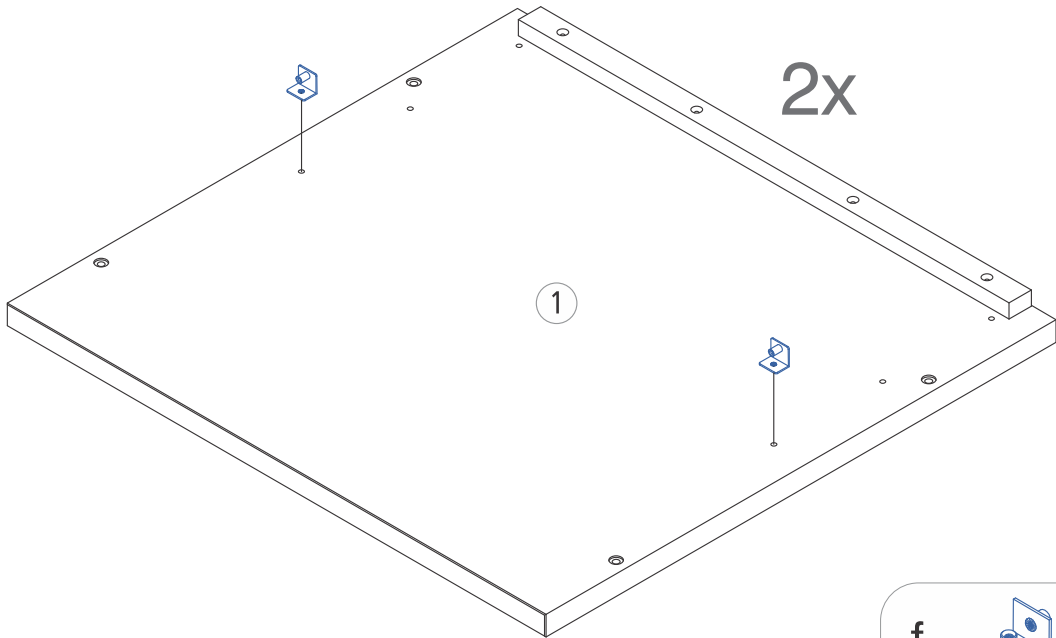

**Highest position of mattress support**  
(newborn)

**Middle position of mattress support**  
(between 2/4 months)

**Lowest position of mattress support**  
(between 5/8 months)

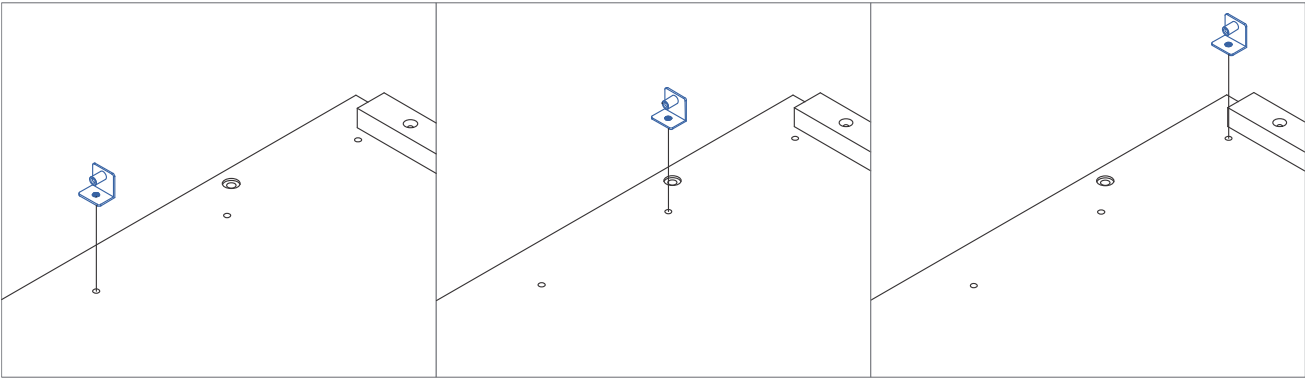

1





2

3

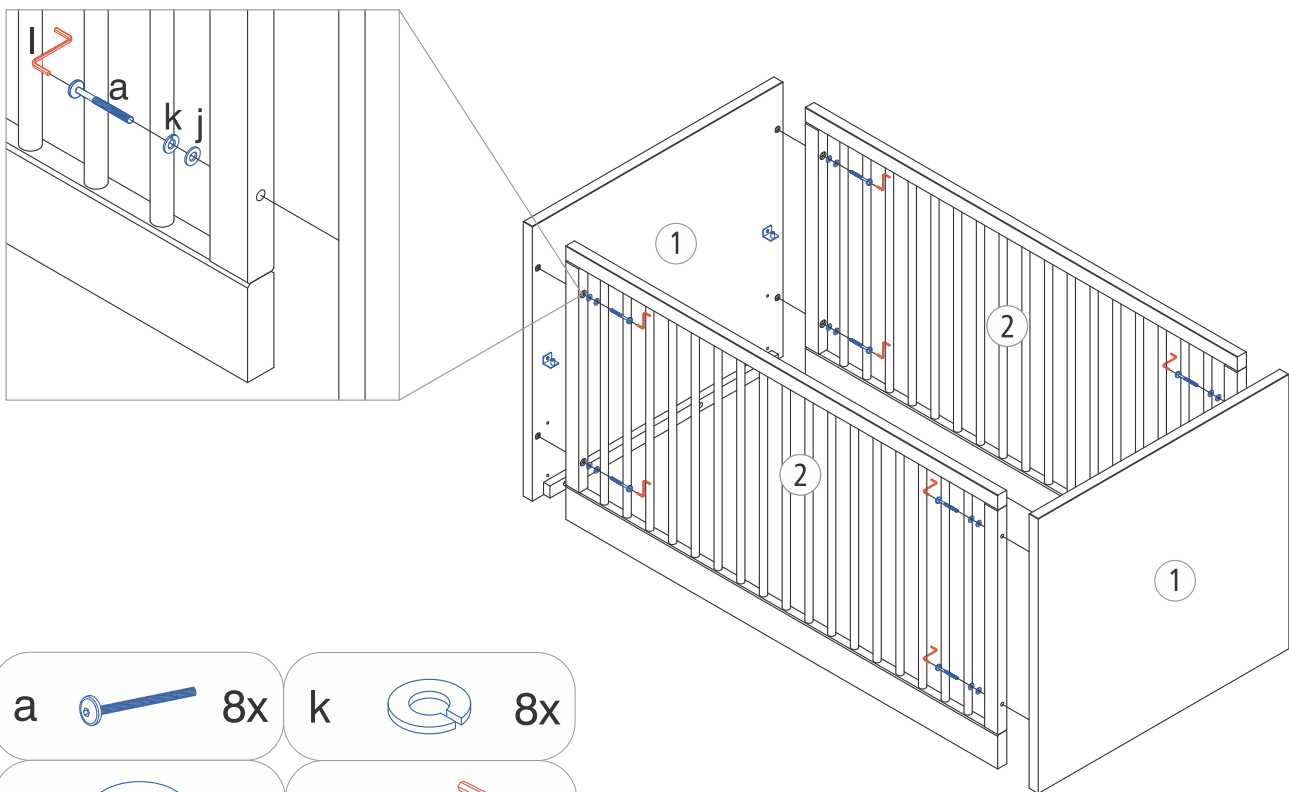
4

5



- |   |  |    |   |  |    |
|---|--|----|---|--|----|
| a |   | 8x | k |   | 8x |
| j |  | 8x | l |  | 1x |

1

2

3

4

5

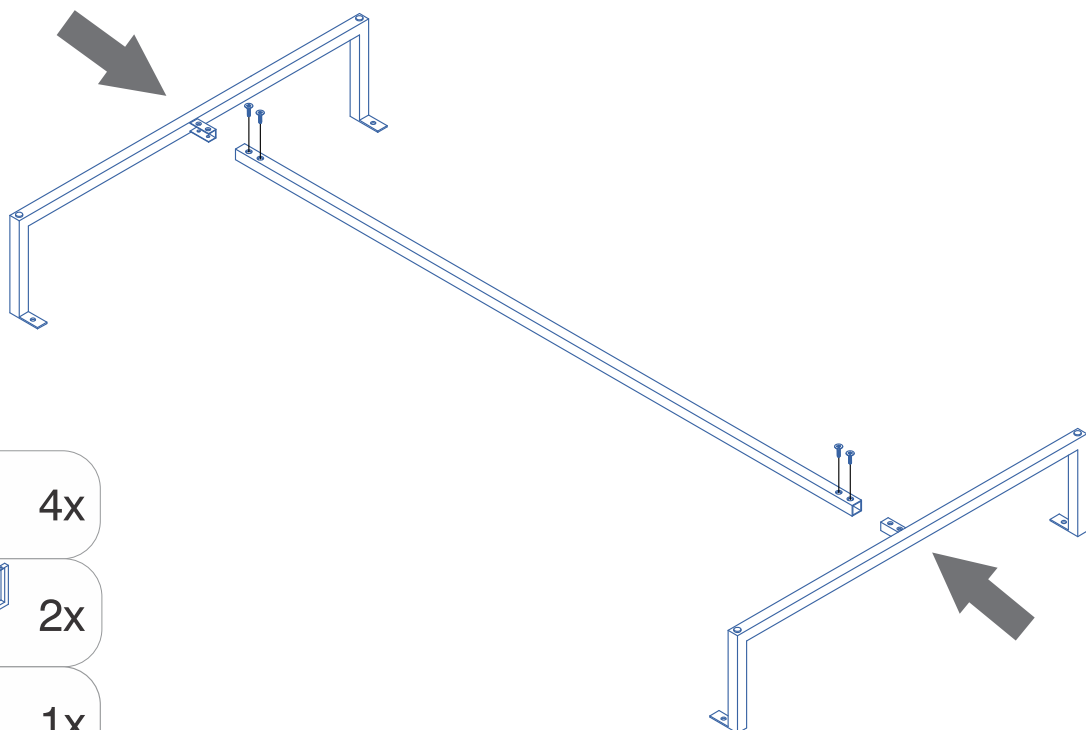

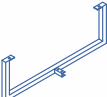
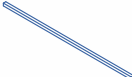
- |   |   |    |
|---|---|----|
| c |  | 4x |
| d |  | 2x |
| e |  | 1x |



1



2

3

4

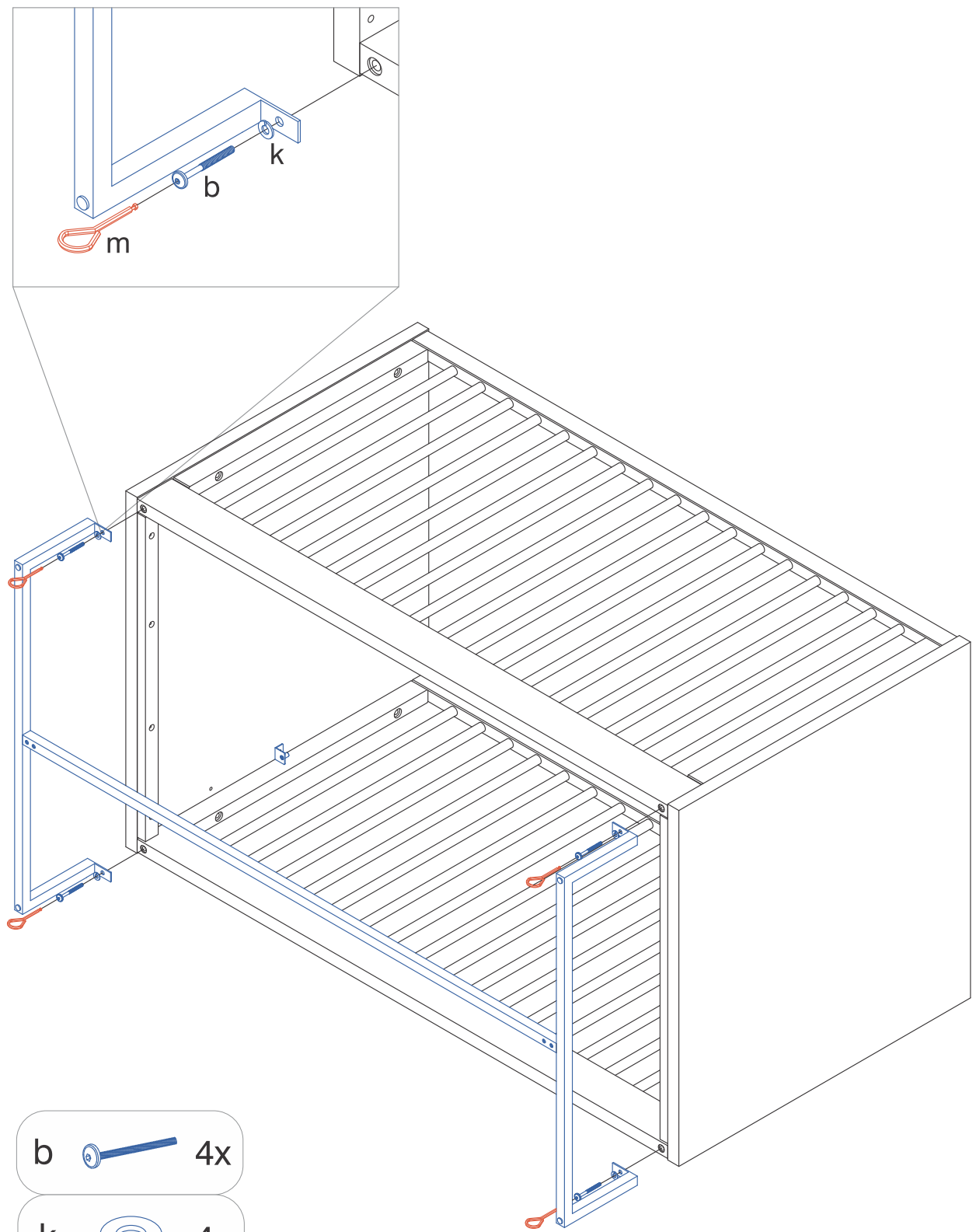
5



- b  4x
- k  4x
- m  1x



1

2

3

4

5

- g  4x
- h  4x
- i  4x

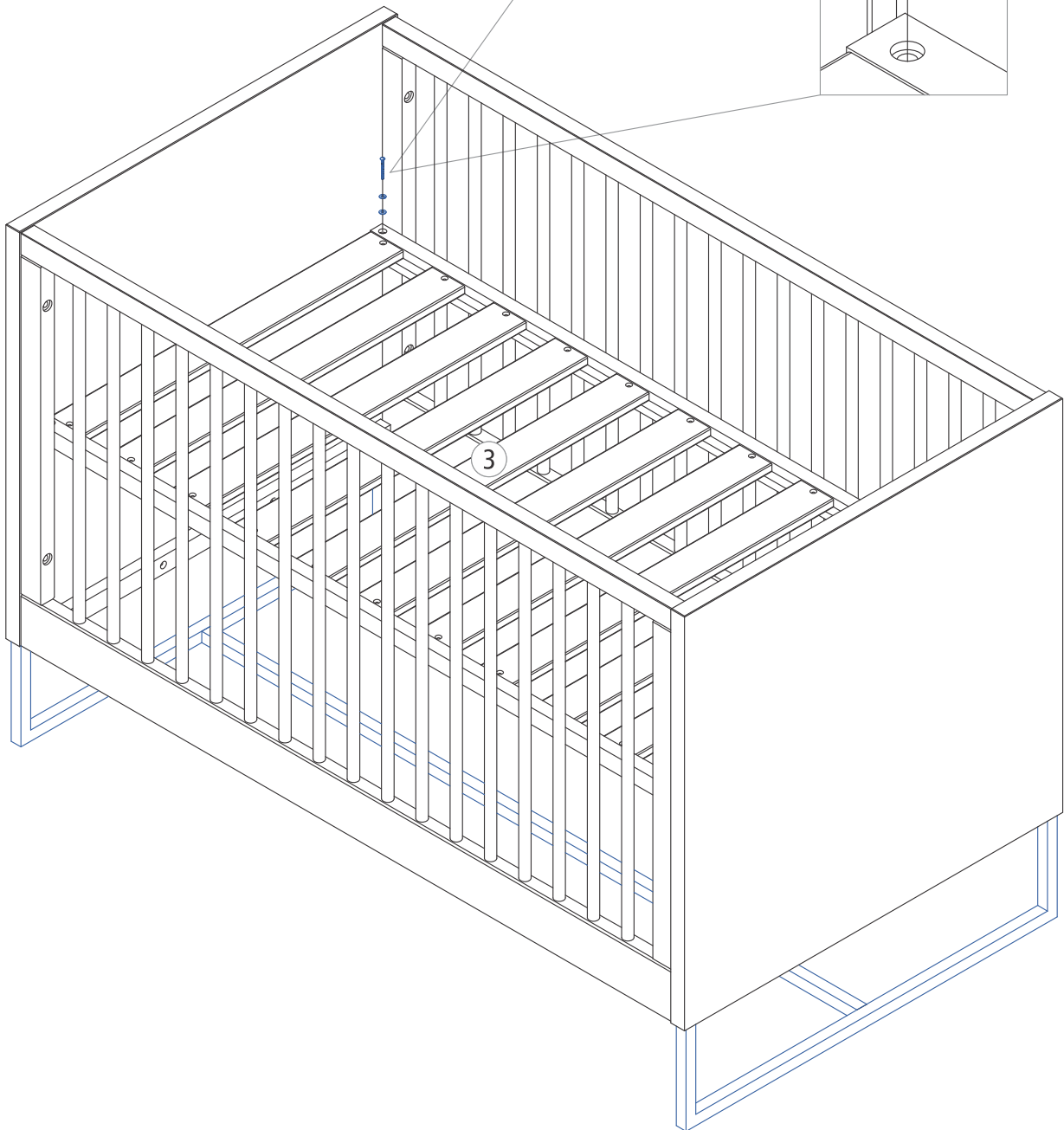
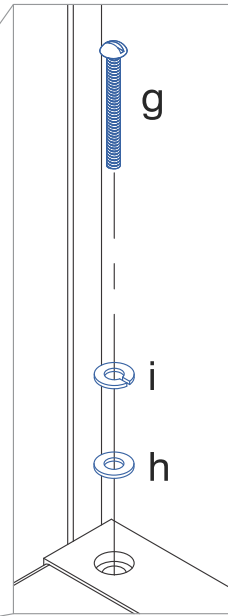

## Optional Step

n



4x

The hardware 'n' are levelers, attach it to your crib when necessary.

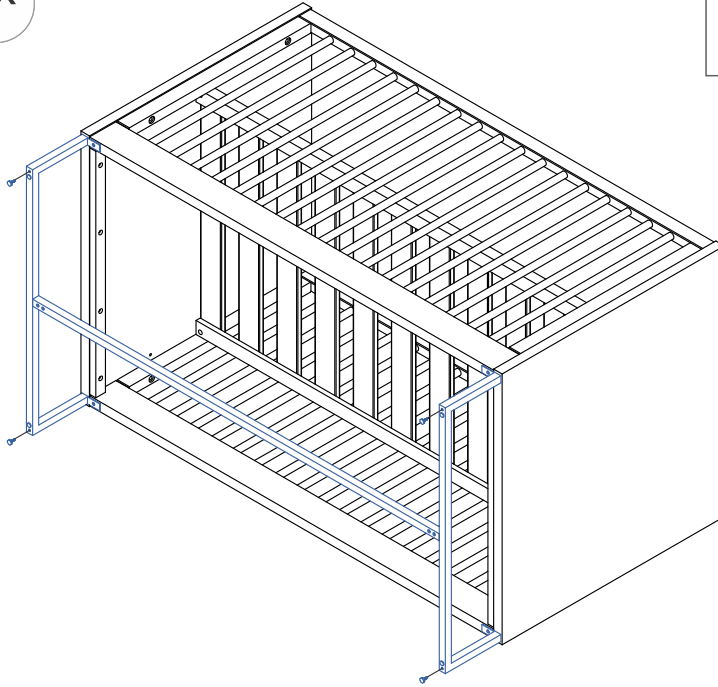

## Convertible Crib

This crib can be adjusted as your child grows. It can be converted into a toddler bed (conversion kit sold separately).

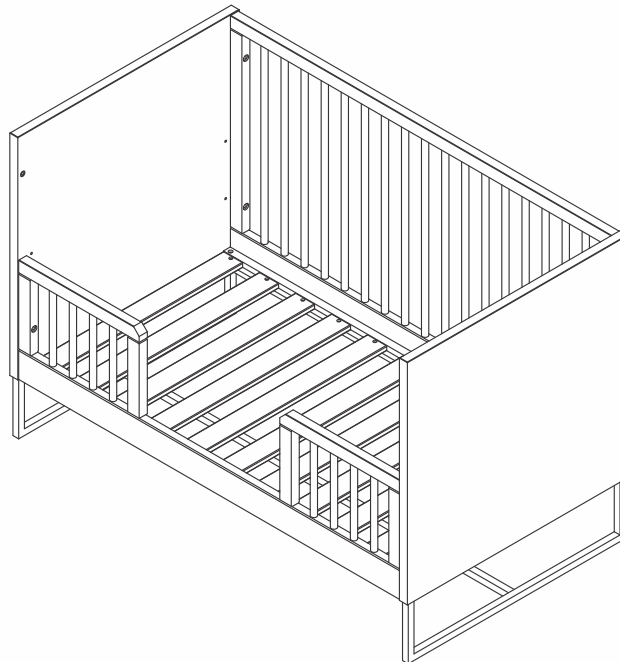

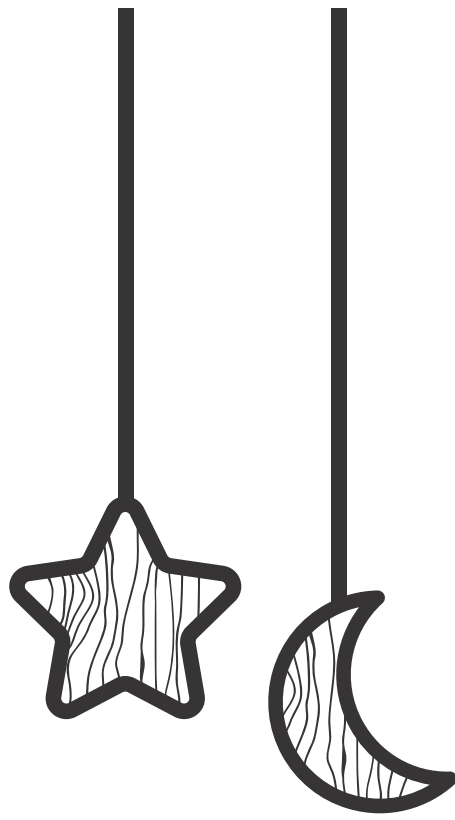

[www.simplynursery.com](http://www.simplynursery.com)  
[contact@simplynursery.com](mailto:contact@simplynursery.com)