



DENVER

convertible crib

ASSEMBLY INSTRUCTIONS

Read all instructions
BEFORE assembly and
USE of product.

**KEEP INSTRUCTIONS
FOR FUTURE USE.**



assembling
2 people



time
approximately 1 hour



tools
philips screwdriver, rubber hammer

www.simplynursery.com

Manufacturer Móveis Caftor Ltda. Rio Negrinho/SC - Brazil - 89295-000.

Distributed in the USA by: SIMPLY NURSERY, LLC. Orlando/Florida - 32819 - United States - 1-888-343-0730

Crib Warnings

CAUTION: ANY MATTRESS USED IN THIS CRIB SHALL BE AT LEAST 27 1/4 BY 51 5/8 INCHES WITH A THICKNESS NOT EXCEEDING 6 IN.

! WARNING

Infants can suffocate in gaps between crib sides and mattress that is too small.

! WARNING

Infants can suffocate on soft bedding.
Never add a pillow or comforter.
Never place additional padding under an infant

! WARNING: Failure to follow these warnings and the assembly instructions could result in serious injury or death.

! WARNING: Never use plastic shipping bags or other plastic film as mattress covers because they can cause suffocation.

! WARNING: Read all instructions before assembling crib. Keep instructions for future use.

- To reduce the risk of SIDS, pediatricians recommend healthy infants be placed on their backs to sleep, unless otherwise advised by your physician.

! Strangulation Hazard:

- Strings can cause strangulation! Do not place items with a string around a child's neck, such as hood strings or pacifier cords. Do not suspend strings over a crib or attach strings to toys.
- To help prevent strangulation tighten all fasteners. A child can trap parts of the body or clothing on loose fasteners.
- DO NOT place crib near window where cords from blinds or drapes may strangle a child.

! Fall Hazard:

- When child is able to pull to a standing position, set mattress to lowest position and remove bumper pads, large toys and other objects that could serve as steps for climbing out.
- Stop using crib when child begins to climb out or reaches the height of 35 in (89 cm).
- Check this product for damaged hardware, loose joints, loose bolts or other fasteners, missing parts, or sharp edges, before and after assembly and frequently during use. Securely tighten loose bolts and other fasteners. DO NOT use crib if any parts are missing, damaged or broken. Contact Simply Nursery, LLC for replacement parts and instructional literature if needed. DO NOT substitute parts.

! WARNING: Follow warnings on all products in a crib.

- DO NOT use this crib if the instructions cannot be strictly followed.
- DO NOT use a water mattress with this crib.
- If refinishing, use a non-toxic finish specified for children's product.
- Do not place this crib near a window or a patio door where a child could reach the cord of a blind or curtain and be strangled.
- Parents should ensure a safe environment for the child by checking regularly, before placing the child in the product, that every component is properly and securely in place.

Toddler Bed Warnings

THE INTENDED USER'S MINIMUM AGE MUST BE AT LEAST 15 MONTHS OLD AND MAXIMUM WEIGHT MUST NOT EXCEED 50 LBS (22.7 KG).

⚠ WARNING:

Failure to follow these warnings and the assembly instructions could result in serious injury or death.

⚠ WARNING:

INFANTS HAVE DIED IN TODDLER BEDS FROM ENTRAPMENT.

Openings in and between bed parts can entrap head and neck of a small child.

NEVER use bed with children younger than 15 months.

ALWAYS follow assembly instructions.

⚠ WARNING:

STRANGULATION HAZARD

NEVER place bed near windows where cords from blinds or drapes may strangle a child.

NEVER suspend strings over bed.

NEVER place items with a string, cord, or ribbon, such as hood strings or pacifier cords, around a child's neck. These items may catch on bed parts.

⚠ CAUTION:

To avoid dangerous gaps, any mattress used in this bed shall be a full-size crib mattress at least 51 5/8 in. (1310 mm) in length, 27 1/4 in. (690 mm) in width, and a maximum thickness of 6 in. (15 cm).

- Read all instructions before using the product. Keep the instructions for future use.
- As with all infant and baby furniture, it is important to check fasteners, screws, and bolts periodically for tightness. Parents should ensure a safe environment for their child by checking the furniture regularly before placing the child in the product.

Care and Cleaning

To remove accumulated dust of your wood product use a soft, lint-free cloth. For a deeper cleaning use a soft lint-free cloth which has been dampened on a solution of neutra detergent and warm water. Do not use oily products, abrasives, amonia, or other aggressive products of cleaning.

Prevention

How to prevent your wood furniture from warping, cracking or dying out:

- Keep moderate temperatures (70°F - 72°F) and humidity around 50% - 55% in your home set.
- Ensure your humidifier is working properly.
- Avoid recurrent and/or sudden variation in humidity.
- Place your wood furniture away from heat sources, for example, but not limited to fireplaces or radiators.
- Keep your furniture away from direct sunlight.
- Use a dehumidifier during rainy seasons to remove excess moisture from the air.

DENVER

convertible crib

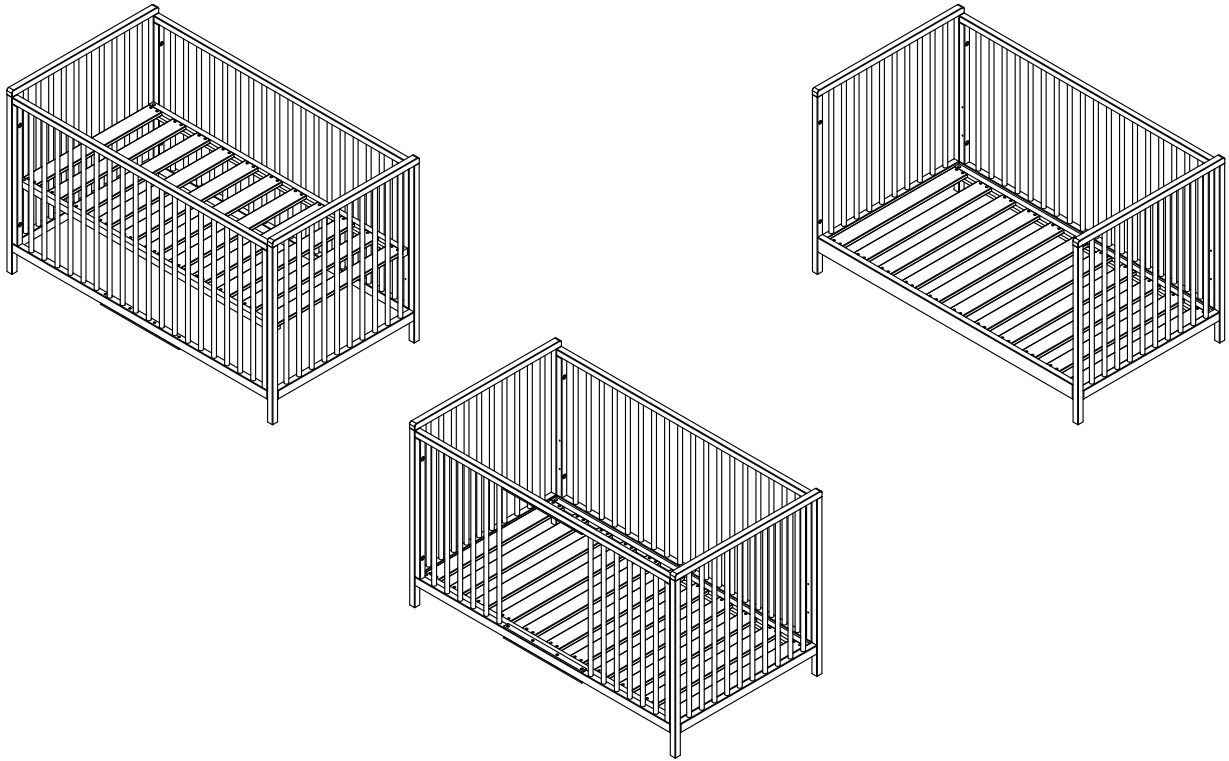

Parts

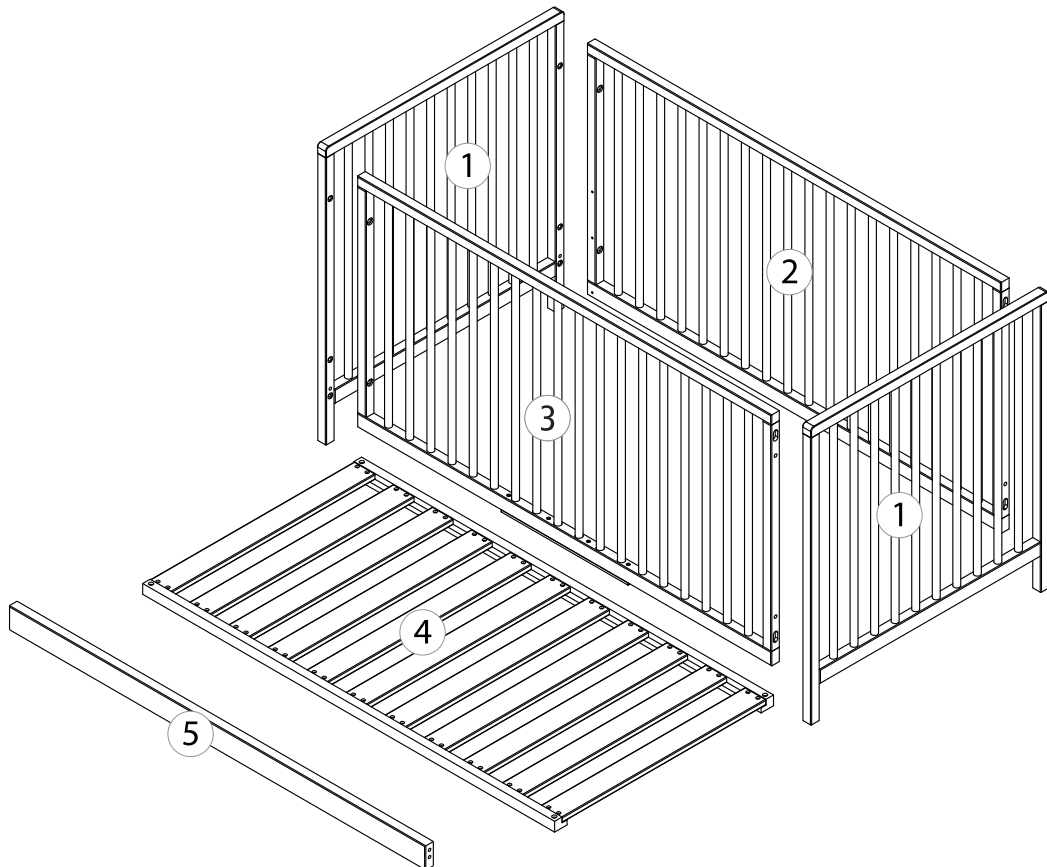

Finish



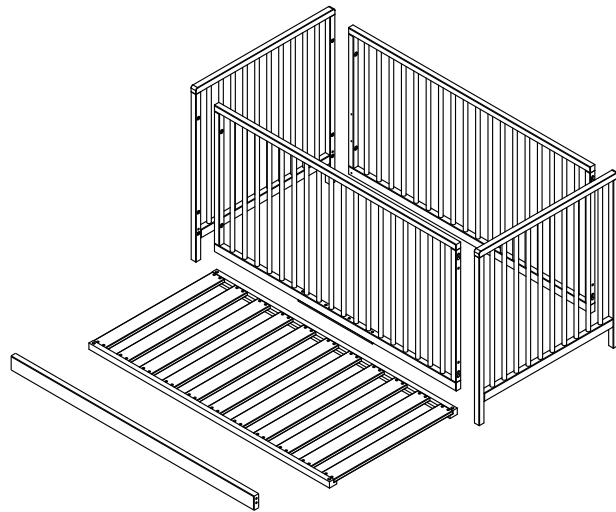





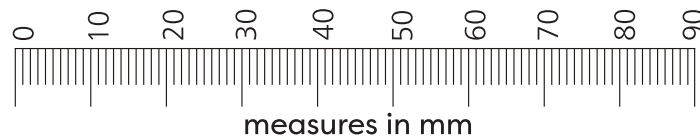

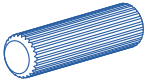

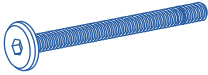
 pieces of wood

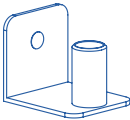
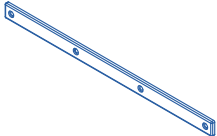

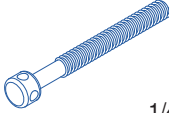
Hardware Set

Use the ruler below to measure the hardware:



a	 Ø 8 x 30	2 pcs	h	 Ø 13,5 mm	8 pcs
b	 1/4 x 40	8 pcs	i	 Ø 4 x 16	8 pcs
c		4 pcs	j		2 pcs
d		4 pcs	k	 1/4 x 60	2 pcs
e	 Ø 10 mm	4 pcs	l		2 pcs
f	 Ø 8 mm	4 pcs	m		1 pc
g	 Ø 17 mm	8 pcs	n		1 pc

Full Crib

1

2

3



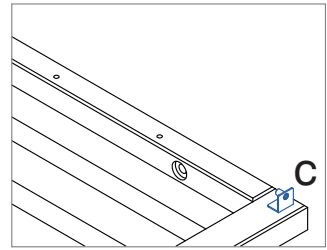
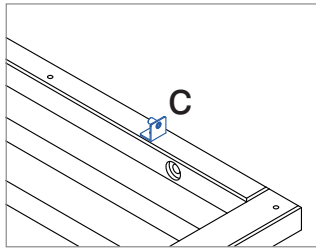
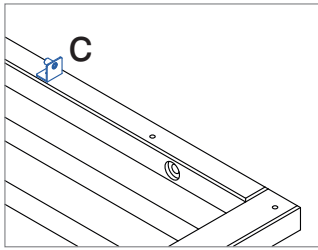
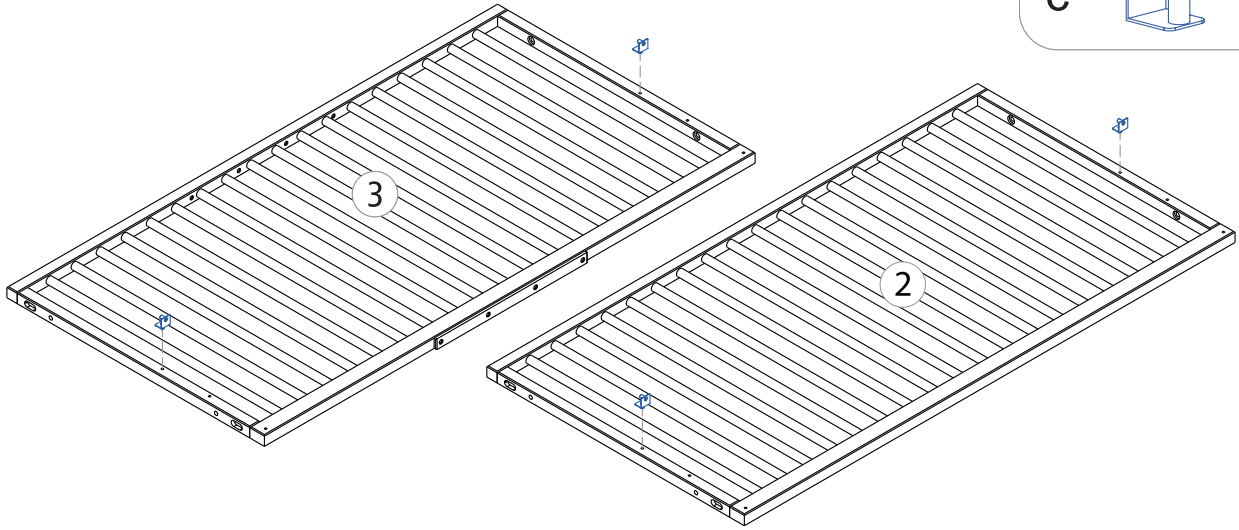

c  4x



1

2

3

b  8x	h  8x
g  8x	m  1x

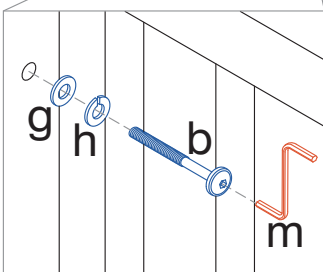
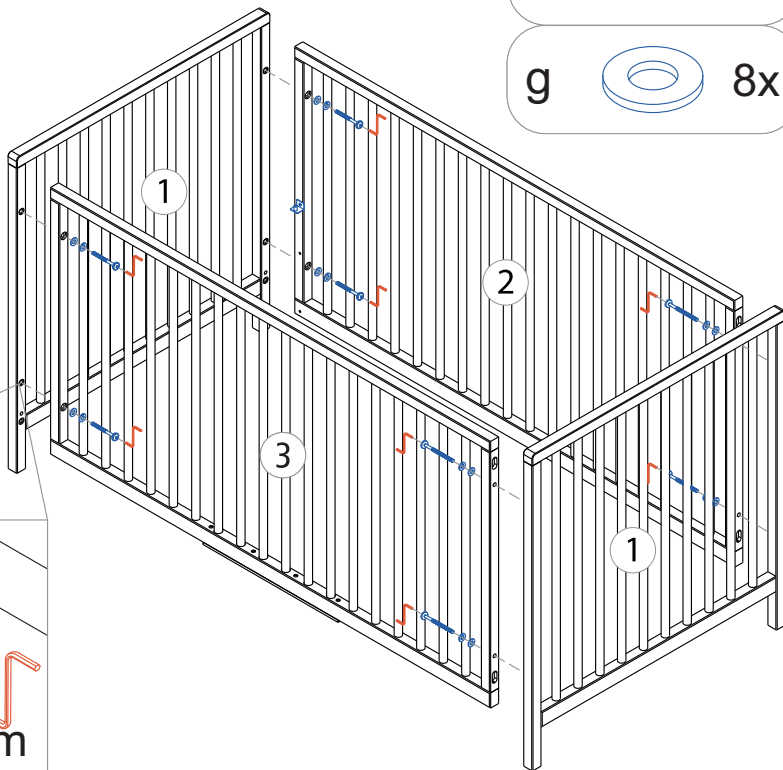

1

2

3

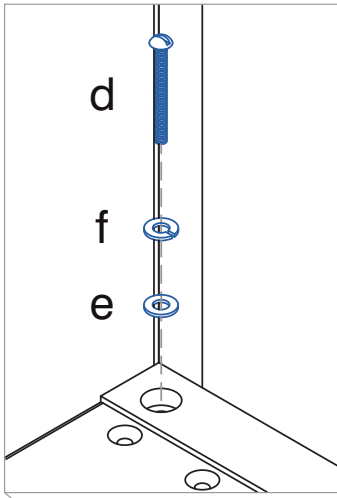

d  4x

e  4x

f  4x

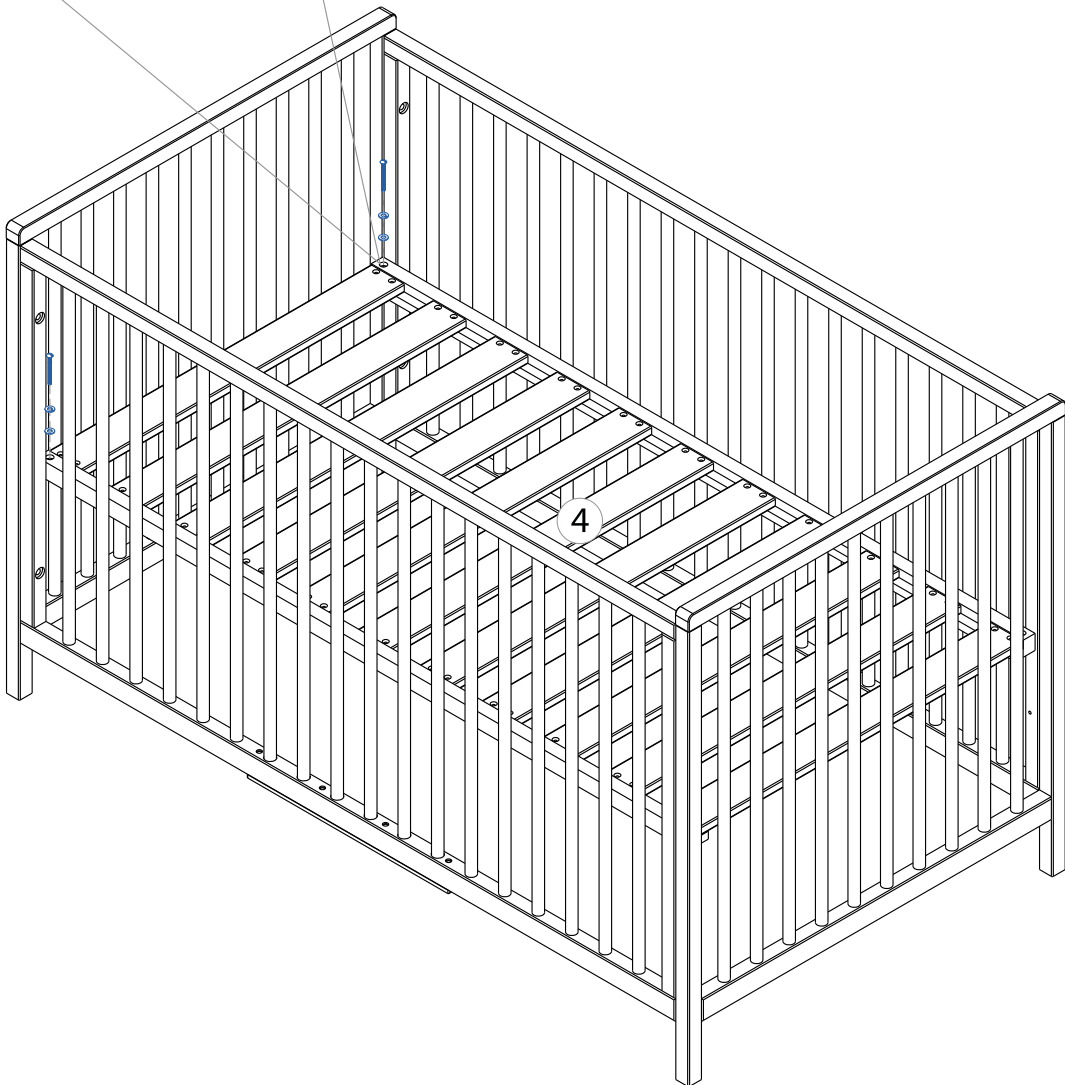

4

Toddler Bed A

1

2

3

4

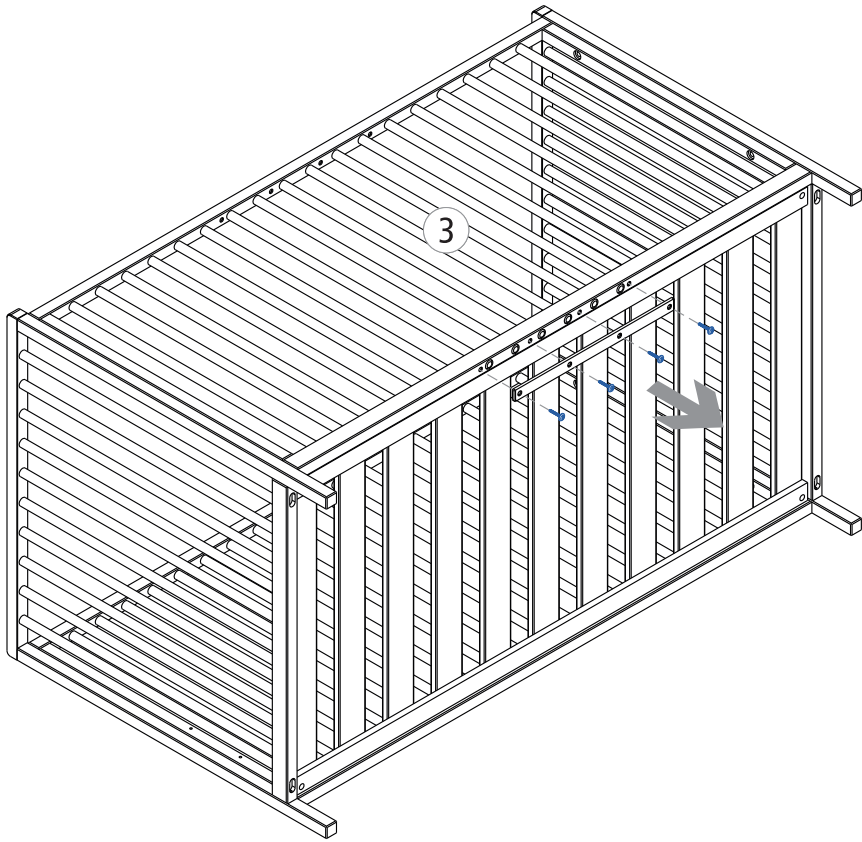

1

2

3

4

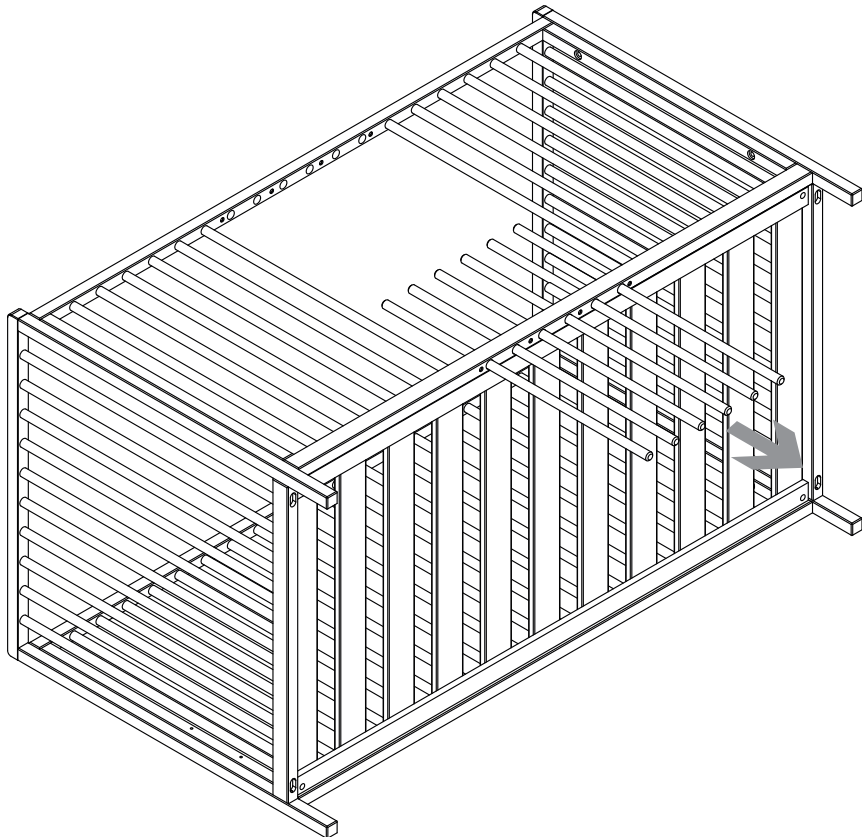

1

2

3

4

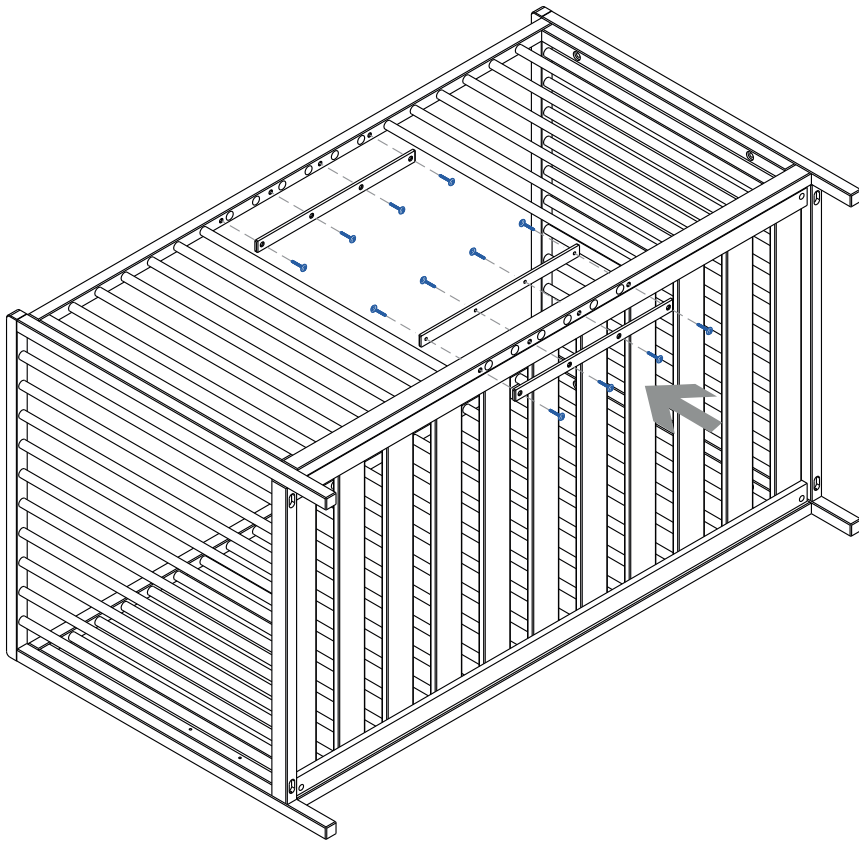

i 8x



j 2x

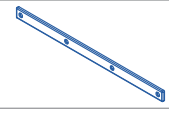

1

2

3

4

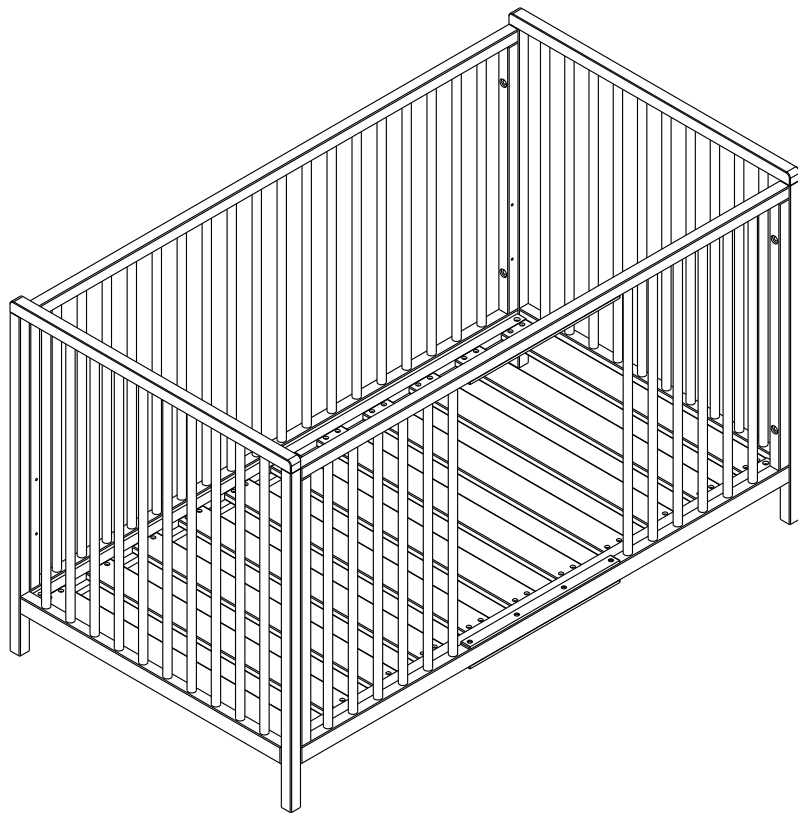

Toddler Bed B

1

2

3

4

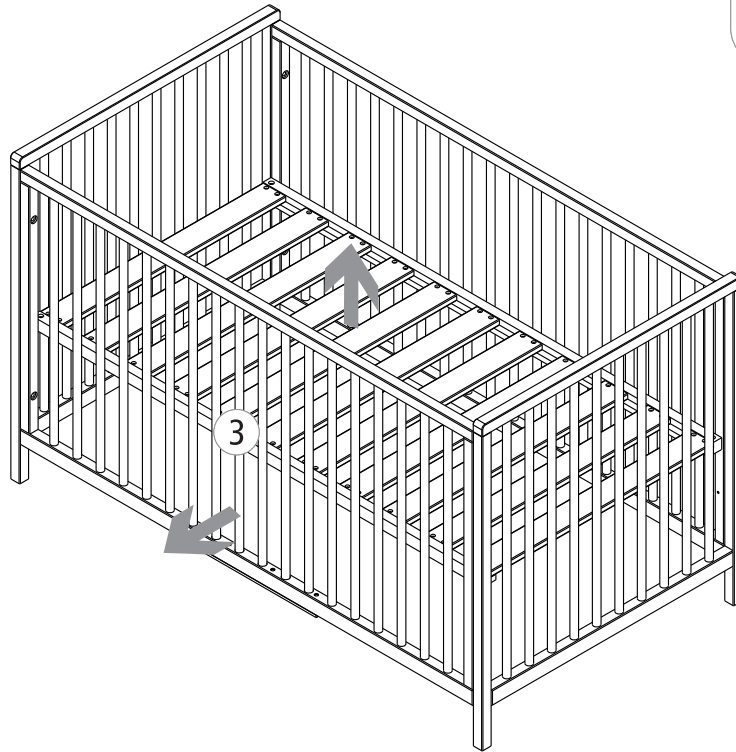
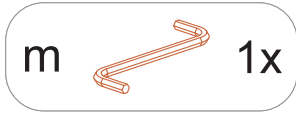

1

2

3

4



When converting the crib, use the same side rail (part #3) hardware.

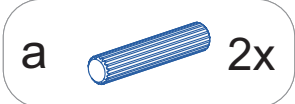
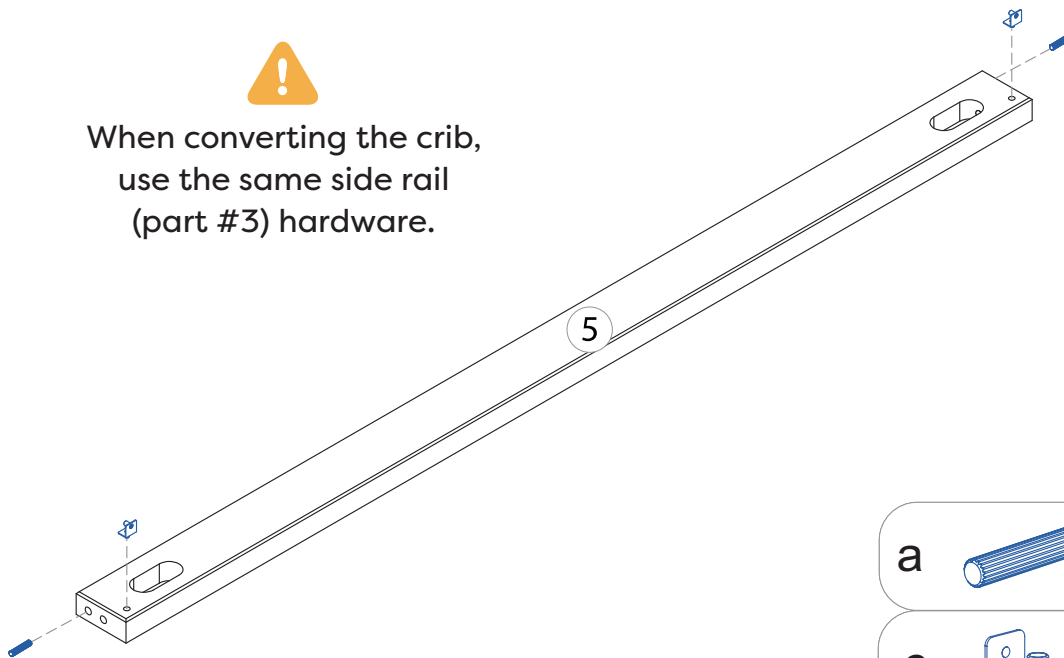

1

2

3

4

k  2x

l  2x

n  1x

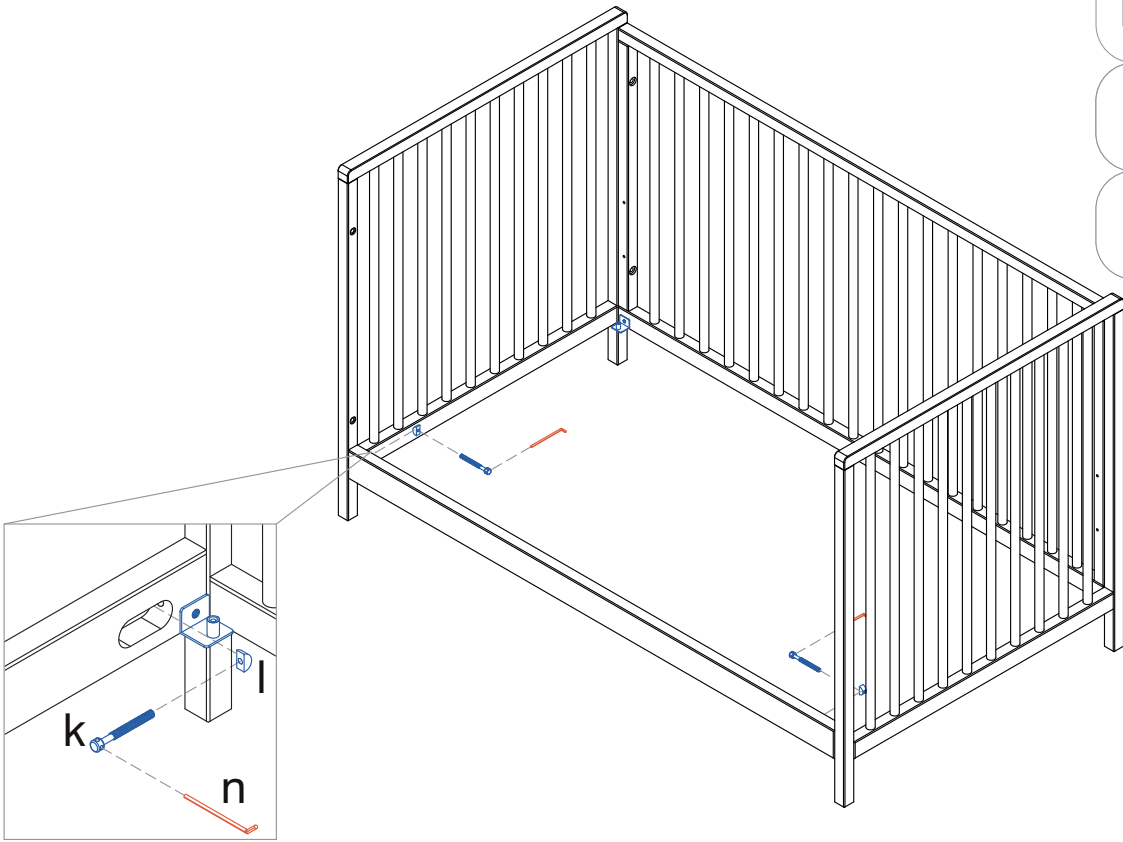

1

2

3

4

d  4x

e  4x

f  4x

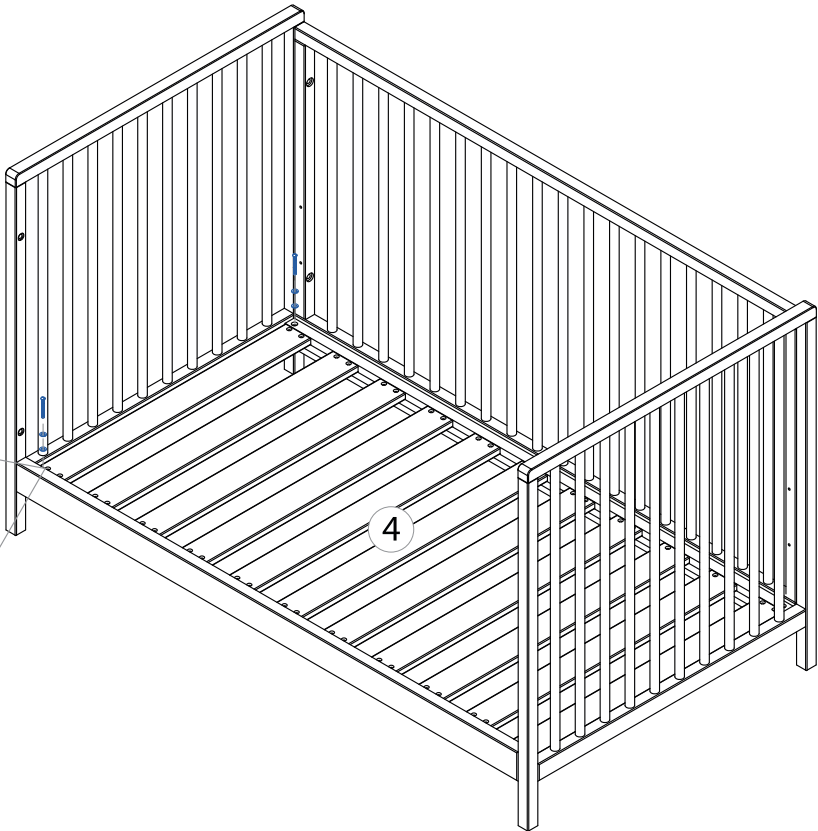
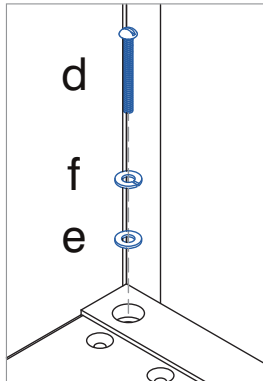

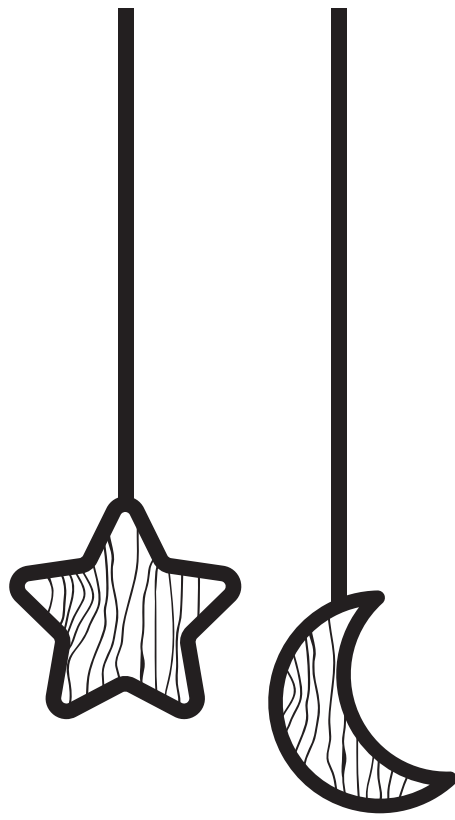

www.simplynursery.com
contact@simplynursery.com