

# KAKA Industrial®

## Specifications

Stock No. ....173214  
 Height.....38"  
 Mild Steel Capacity.....5/16"x1-1/4"  
 or 1/4" x 2"  
 Right Angle Bending Capacity.....3/16"  
 x 1-1/4" or 1/4" x 1-1/4"  
 Center Pin Capacity.....1/4" thick  
 (use 1" die for greater)  
 Solid Rod Capacity.....1/2" (use 3" die)  
 Die Sizes.....1" ,1-1/4" ,1-1/2" ,1-3/4" ,  
 2" ,2-1/2" ,3"  
 Bending Angle.....0-200°  
 Packing dimensions.....880x265x265mm  
 (34 5/8x10 7/16 x10 7/16 inches)  
 Net weight.....19.5KGS (43 lbs.)

have occurred during transit.

If damage has occurred, shipping damage claims must be filed with the carrier and are the responsibility of the user.

Check for completeness. Immediately report missing parts to dealer.

### Warning

The warnings, cautions and instructions discussed in this instructions or situations that could occur. It must be understood by the operator that common sense and caution are factors which cannot be built into this product, but must be supplied by the operator.



## Unpacking

The COMPACT BENDER Y-P38 is shipped from the manufacture in a carefully packed Carton box. Thoroughly inspect the product upon opening the package. After unpacking the unit, carefully inspect for any damage that may

## SAVE THESE INSTRUCTIONS

Thank you for purchasing our YP-38 Compact Bender. Before attempting to operate your new tool please read these instructions thoroughly. You will need these instructions for the safety warnings, precautions, assembly, operation, maintenance procedures, parts list and diagrams. Keep your invoice number with these instructions. Write the invoice number on the inside of front cover. Keep the instructions and invoice in a safe, dry place for future reference.

# Model YP-38

---

## SAFETY RULES

1. **Know your machine.** Read this manual carefully. Learn the machine's applications and limitations, as well as specific potential hazards peculiar to it.
2. **Keep work area clean and well lit.** Cluttered or dark work areas invite accidents.
3. **Keep Children away.** All children should be kept away from the work area. Never let a child handle a tool without strict adult supervision.
4. **Do not operate this tool if under the influence of alcohol or drugs.** Read warning labels on prescriptions to determine if your judgment or reflexes are impaired while taking drugs. If there is any doubt, do not attempt to operate.
5. **Use safety equipment.** Eye protection should be worn always when operating this machine. Use ANSI approved safety glasses. Everyday eyeglasses only have impact resistant lenses. They are NOT safety glasses. Dust mask, non-skid safety shoes, hard hat, or hearing protection should be used in appropriate conditions.
6. **Wear proper apparel.** Loose clothing, gloves, neckties, rings, bracelets, or other jewelry may present a potential hazard when operating this machine. Please keep all apparel clear of the machine.
7. **Don't overreach.** Keep proper footing and balance always when operating this product.
8. **Check for damage.** Check your tool regularly. If part of the tool is damaged it should be carefully inspected to make sure that it can perform its' intended function correctly. If in doubt, the part should be repaired. Refer all servicing to a qualified technician. Consult your dealer for advice.
9. **Keep your hands away from the die when you are working on it.**
10. **Avoid moving parts during operation.** Deep fingers and hands away from moving parts.
11. **Stay alert.** Watch what you are doing. Use common sense. Do not operate any tool when you are tired.
12. **Replacement parts and accessories.** When servicing, use only identical replacement parts. Only use accessories intended for use with this tool.
13. **Store idle equipment.** When not in use, the tool should be stored in a dry location to inhibit rust. Store in an area out of reach of children.

# KAKA Industrial®

14. **Secure stand.** Make sure the unit is securely mounted to a stable surface before operation.

15. **Do not exceed the capacity of the unit.** Do not use cheater bars or extends handle with any other devices.

16. **Check all pins before use.** Make sure all pins are inserted all of the way.

17. **Make sure stock is of sufficient length.** Stock must extend far enough by the Stop Block & Forming Die so as not to slip and cause injury.

## Important

The dies are coated with a protective coating which should be removed before operation. Remove this coating with a mild solvent such as mineral spirits using a soft cloth. Avoid getting cleaning solution on painted surfaces, rubber or plastic parts. Solvents may deteriorate these finishes. Use soap and water on paint, plastic and rubber components. After cleaning, cover all exposed surfaces with a light coating of oil.

## Assembly

1. Take out Stand (#11), bolt it to the floor securely.



**Figure 1**

2. Put spacer ring (#13) on to the hole of stand (#11) refer to Figure 1.



**Figure 2**

3. Put Ring assembly (#10) onto the hole of spacer ring (#13), please refer to figure 2.

4. Insert loop spacer (#6) into the end hole of ring assembly (#10), connecting them by bolt (#15), flat washer (#24), lock washer (#27) and nut (#14).

5. Connecting flat-head bolt (#16) lock washer (#27) and nut (#14) with another two spacer ring (#13), make Ring assembly (#10) fixed on stand (#11).

# Model YP-38

6. Insert fixed stop (#5) into the required hole, show as figure 3.

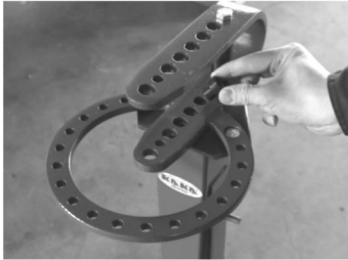

**Figure 3**

7. Connect sharp-angle-bend Attachment (#7) with Ring assembly (#10) by Long Hitch pin (#1), show as figure 4.



**Figure 4**

8. Take out Handle (#9) and any die, connect them with Ring assembly (#10) by Long Hitch pin (#1), show as figure 5.



**Figure 5**

9. Take out stop block (#3), connect it with ring assembly (#10) by short hitch pin (#2), show as figure 6.

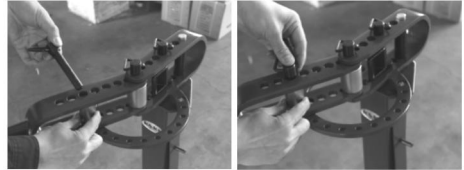

**Figure 6**

## Basic Operation

Most of this manual is devoted to showing you how to make some common parts at a typical size. Other than those specific instructions, setting up the Bender to form your particular parts will involve a certain amount of trial-and-error. You will notice some differences in operation depending on whether you are forming the piece around a die, or whether you are making a sharp angle bend in the piece. However, in general you will:

1. Determine the appropriate material and size for the part(s) to be made.
2. Determine the appropriate dies to install on the center pin and/or the pin installed in the handle. Determine the appropriate hole for attaching the handle to the ring assembly's loop.
3. Install the stop block (#3) or the

# KAKA Industrial®

sharp-angle-bend attachment (#7), as appropriate. Install the block support (#4). If the stop block (#3) is used, orient it properly.

4. Insert the stop block (#3) into the bender, and position it properly for the first bend.

5. Make the first bend. Recheck the angle and location before continuing.

6. Make any additional bends in the same way. In some cases, you may have to remove the piece from the Bender and turn it end-for-end or upside-down.

## Hole Identification

In the examples shown in this manual, the holes in the loop and those in the handle are identified by a number. Refer to the Figure 7.

### Hole Identification

#### Holes in Handle

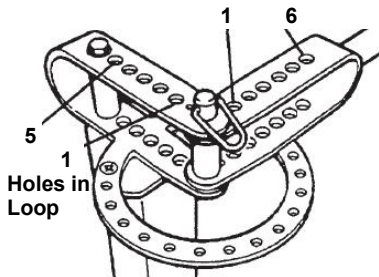

Figure 7

## Measuring Bend Angles

When accuracy is required, you will need a suitable device for measuring the bend angles.

## Fixed and Adjustable Stops

If you are making multiple parts with the same bend angle, using the same setup (dies and hole locations), the operation will be go faster by installing either the fixed or adjustable stop in the appropriate hole in the ring assembly.

After determining the handle rotation, insert the fixed stop (#5) into the next open hole and use as a guide for bending additional parts.

When greater precision is required, attach the adjustable stop (#26) as accurately as you can at the limit of handle rotation. Make a test part with scrap material, and reposition the adjustable stop as necessary. Tighten bolt and nut securely before bending production parts.

Fixed and adjustable stops shown in figure 8.

# Model YP-38

## Fixed and Adjustable Stops

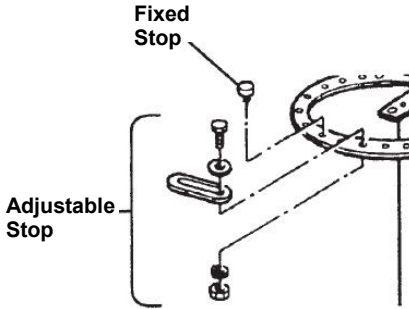

## Notes

- ◆ If precise dimension are required, start by making a test part using scrap material of the same thickness. Readjust the setup as necessary.
- ◆ Once you determine the dimensions, die size(s), holes, and bending sequence for a part, write down the information for future reference.

## Operation: Using the Stop Block

**IMPORTANT:** Read the previous section before you proceed to this section.

### Purpose of the Stop Block

The stop block (#3) prevents the material from rotating while a forming die in the

handle bends the material around either the center pin (#2) or another die that has been installed on the center pin.

When you are bending material, the stop block will be located (using a hitch pin) at one of the five large holes in the middle of the ring assembly's loop. (The large hole at the open end of the loop is for the center pin.) You will have to determine by trial which hole you will use, depending on the thickness of the material being bent, the size of the center-pin die, and the orientation of the stop block. (shown in figure 9)

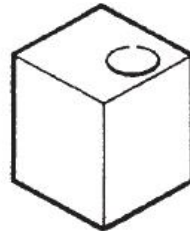

Figure 9

### Positioning the Stop Block

The stop block (#3) can be placed in several orientations by rotating it on the hinge pin or by turning it upside down and rotating it on the pin. However, only four of the possible orientations are used

# KAKA Industrial®

when bending. Throughout this manual, those four orientations are identified by a number (shown as figure 10).

## Stop Block Orientations

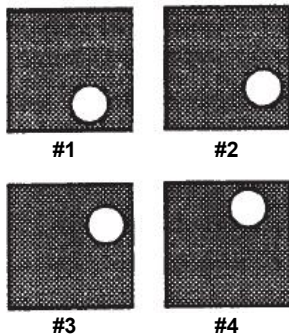

Figure 10

**CAUTION:** Always position the stop block **off-center to the right**—no matter which face is used against the material. If positioned off-center to the left, the block will turn and the material will slip in the Bender.

To position the stop block (#3) (that is, to select the proper orientation and the proper hole in the loop):

1. Connect the handle to the center pin of the loop, with the appropriate die installed on the center pin.

2. Install the appropriate die at the appropriate hole in the handle.

3. Inset a piece of the material to be formed. With the handle all the way back (counterclockwise), install the stop block—in the orientation that places it as close to the center pin as possible.

**IMPORTANT:** Always use the loop hole that places the stop block as close to the center pin or die as possible, while leaving space for the material to be inserted.

If there is too much space between the stop block and the center pin or die, turn the block to a different orientation or move the block one hole closer to the center.

## Positioning the Block Support

The block support must be located under the stop block as shown as figure 11, to keep the block centered vertically in the loop.

Install the support in the appropriate loop hole where it will support the stop block but not interfere with inserting the hitch pin all the way through the block hole and the lower hole in the loop.

# Model YP-38

Positioning the Block Support

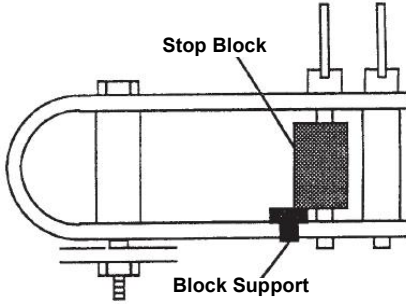

Figure 11

## Clamping

If the stop block is positioned correctly, the material will normally not have to be clamped in the Bender. However, when you are making special bends or need precise dimensions, it is helpful to clamp the material against the stop block using a vise-grip pliers as shown as figure 12.

Clamping the Material

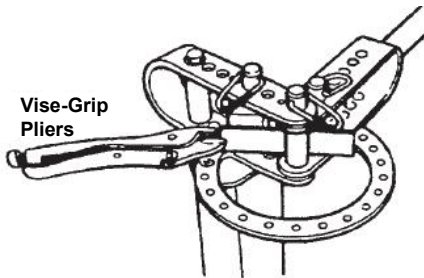

Figure 12

## Operation: Using the Sharp-Angle-Bend Attachment

**IMPORTANT:** Read the previous section before you proceed to this section.

### Purpose of the Attachment

The sharp-angle-bend attachment (#1) is used instead of the stop block (#3) when you make a right-angle bend or other sharp bend in flat material.

Show as figure 13.

Sharp-Angle-Bend Attachment

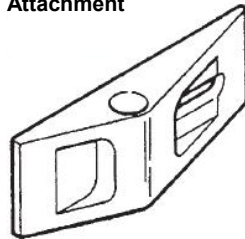

Figure 13

### Positioning the attachment

In contrast to the stop block, the sharp-angle bend attachment has only one correct orientation — as shown as figure 14, and with the hinge pin in the #3 hole in the loop.



# KAKA Industrial®

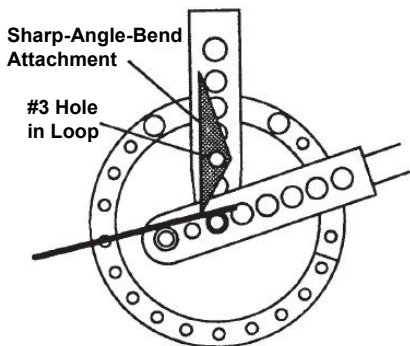

Figure 14

## Positioning the Block Support

The block support must be located under the sharp-angle-bend attachments, to keep the attachment centered vertically in the loop. Install the support in the #3 loop hole, so it will support the attachment but not interfere with inserting the hitch pin all the way through the attachment's hole and the lower hole in the loop.

## Clamping

The material should not need to be clamped when using the sharp - angle bend attachment.

## Bending the Material

Make thin chalk marks on the flat material

to show where you want to make the bends.

Insert the material into the Bender so that half the width of the chalk mark shows and the other half is covered by the bending edge of the attachment.

If you are making **two right-angle bends** on the same side of the material, space their chalk marks about  $\frac{1}{8}$ ". Farther apart than the desired inside dimension after the bend.

## MAINTENANCE

1. Regular lubrication will help lengthen the life of the your Bending Brake.
2. After each use, wipe all components of the compact bender with a clean cloth to remove any dirt and grease buildup.
3. Apply a few drop of oil to all friction points including all (3) hitch pins.
4. Before every use, inspect dies and hitch pins for excessive wear and cracks. If chipped or cracked, replace immediately.
5. Cover the compact bender and keep in a clean and dry location.

# Model YP-38

## Example: Bending Handles

### Handles from Round Stock

To make a typical handle, using a 9" length of  $\frac{3}{8}$ " round stock and two pieces of flat stock:

**CAUTION:** To make other sizes of handles, experiment to find the appropriate die sizes and stop block orientation.

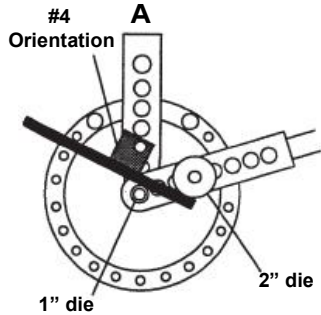

3. Insert the round stock into the Bender so that it extends 2" beyond the center-pin die (see **B**), and make the first bend to 90°.

#### TYPICAL HANDLES FROM ROUND STOCK

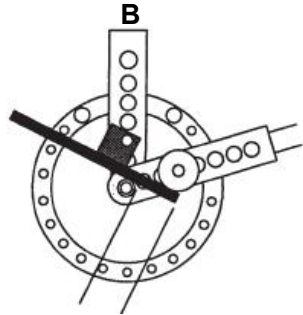

#### STOCK REQUIRED (for this example)

One 9" length of  $\frac{5}{8}$ " round stock, Two pieces of flat stock, of desired size.

1. With a long hinge pin, attach the handle and ring loops at their center-pin holes. Install a 1" die on the center pin. With the short hinge pin, install a 2" die in the handle (#2 hole).
2. With a long hinge pin, install the stop block (oriented as in **A**).

4. Turn the part end-for-end, position it as in **C**, and make the second 90° bend. Remove the stock from the Bender.

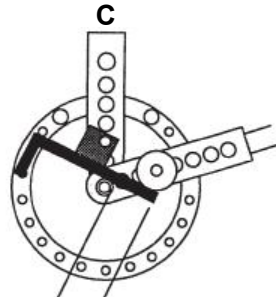

# KAKA Industrial®

5. Drill  $\frac{5}{8}$ " holes in the flat stock, and insert the handle halfway through the holes.

**NOTE:** Always drill the holes the same size as the diameter of the handle stock.

6. Weld the flat stock pieces in place from the back side. If any weld material extends below the surface of the flat plate, grind it flush.

1. Install the sharp - angle - bend attachment.

2. Place chalk marks on the material as shown under "Bend Sequence." the #1 and #2 marks are on one face of the material, and the #3 and #4 marks are on the opposite face.

3. Insert the flat stock into the Bender to the #1 mark (as in **A**) and make a 90° bend. Check the angle before continuing.

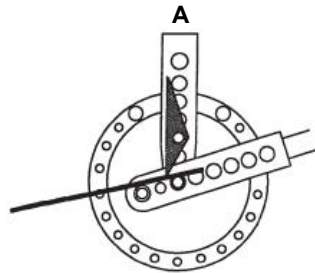

## Example: Bending Handles

### Handles from Flat Stock

To make a typical handle, using a 9" length of  $\frac{3}{16}$ " x 1" hot-rolled flat stock:

**CAUTION:** To make other sizes of handles, experiment to find the appropriate bend locations.

TYPICAL HANDLE FROM FLAT STOCK

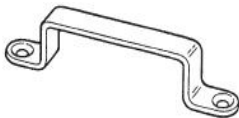

### STOCK REQUIRED (for this example)

One 9" length of  $\frac{3}{16}$ " x 1" soft ductile flat stock

**BEND SEQUENCE**

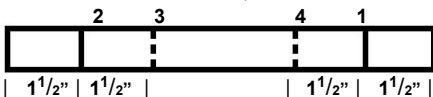

4. Set the adjustable stop so each bend will be 90°.

5. Turn the stock end-for-end. Insert it to the #2 mark (as in **B**), and make a 90° bend.

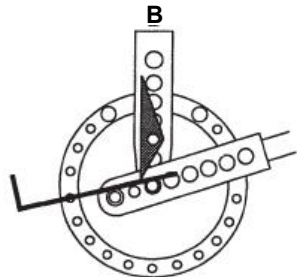

6. Turn the stock over front-to-back. Insert

# Model YP-38

it to the #3 mark (as in **C**), and make a 90° bend.

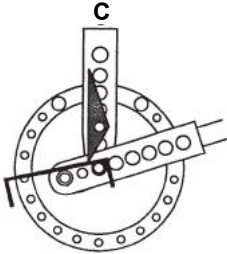

7. Turn the stock end-for-end. Insert it to the #4 mark (as in **D**), and make a 90° bend.

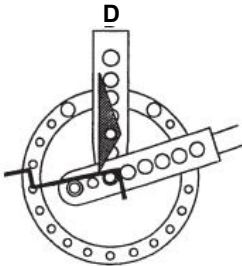

8. Grind and sand all sharp corners.

## Example: Bending Tube Clamps

### Single-Tube Clamp

To make a 1-in. I.D. tube clamp (for clamping 1-in. O.D. tubing), using a 4½-in length of ¾-in. x 1-in. hot-rolled flat stock:

**NOTE:** To make other sizes of clamps, experiment to find the appropriate die sizes and stop block orientation.

### TYPICAL TUBE CLAMPS

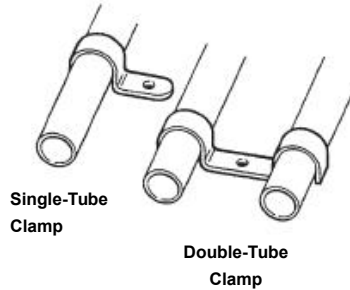

### STOCK REQUIRED (for this example)

One 4½-in. length of ¾-in. x 1-in. hot-rolled flat stock

1. With a long hinge pin, attach the handle and ring loops at their center-pin holes. Install a 1-in. die on the center pin. With the short hinge pin, install a 1½-in. die in the handle (#2 hole).
2. With a long hinge pin, install the stop block (oriented as in **A**).

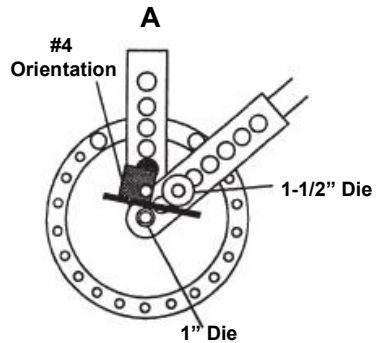

3. Insert the flat stock into the Bender so that it extends 1½-in. beyond the

# KAKA Industrial®

center-pin die (as in **B**).

Clamp the stock against the stop block using a vice-grip pliers, to prevent the stock from slipping.

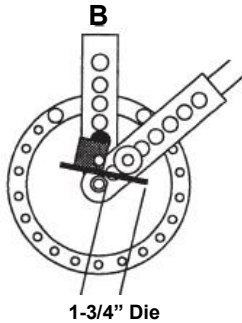

1-3/4" Die

4. Make the first bend by pulling the handle around until the handle die runs off the end of the piece.

5. Remove the stop block and the two dies. Change the handle connection, and install the sharp-angle-bend attachment (as in **C**).

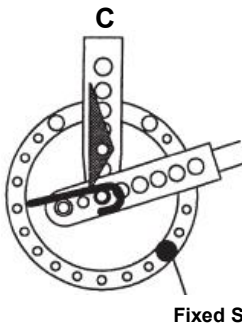

Fixed Stop

6. Insert the stop pin into the 6th hole of the ring (counting clockwise from the closed end of the loop).

7. Make the second bend by pulling the handle until it is about 1/8-in. From the stop pin.

## Double-Tube Clamp

To make a 1-in. I.D. tube clamp (for clamping two lengths of 1-in. O.D. tubing), using a 4 1/2-in length of 3/16-in. x 1-in. hot-rolled flat stock:

**NOTE:** To make other sizes of clamps, experiment to find the appropriate die sizes and stop block orientation.

### STOCK REQUIRED (for this example)

One 6 1/2-in. length of 3/16-in x 1-in. hot-rolled flat stock

1. With a long hinge pin, attach the handle and ring loops at their centerpin holes. Install a 1-in. die on the center pin. With the short hinge pin, install a 1 1/2-in. die in the handle (#2 hole).

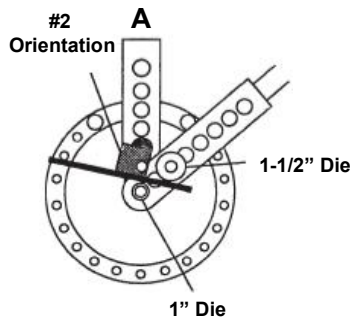

# Model YP-38

2. With a long hinge pin, install the stop block (oriented as in **A**).

3. Insert the flat stock into the Bender so that it extends  $1\frac{3}{4}$ -in. Beyond the center-pin die (as in **B**).

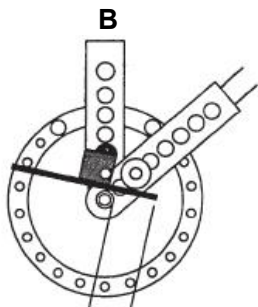

1-3/4" Die

4. Make the first bend by pulling the handle around until the handle die runs off the end of the piece.

5. Reverse the part end-for-end. Insert it into the Bender so that it extends  $1\frac{3}{4}$ -in. beyond the center-pin die (as in **C**).

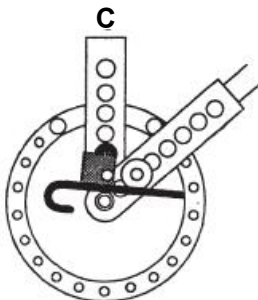

6. Make the second bend by pulling the handle around until the handle die runs off the end of the piece.

7. Remove the stop block, and install the sharp-angle-bend attachment.

8. You will have to temporarily remove the center pin to insert the piece into the Binder. Slide the piece as far left as possible, against the center pin (as in **D**).

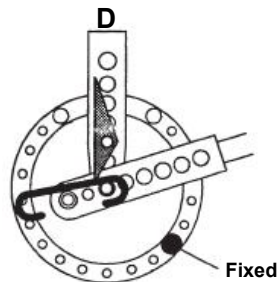

9. Make the third bend by pulling the handle until it is about  $\frac{1}{8}$ -in. from the stop pin.

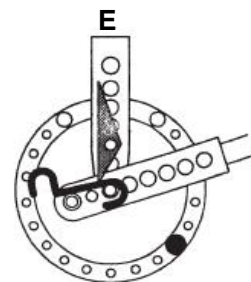

10. Reverse the part end-for-end. Slide the piece as far left as possible, against the center pin (as in **E**). You will again have to temporarily remove the center pin to insert the piece into the Bender.

11. Make the fourth bend by pulling the handle until it is about  $\frac{1}{8}$  in. From the fixed stop.

# KAKA Industrial®

## Example: Bending Anchor Bolts and U-Bolts

### Anchor Bolts

To make a 10-in. long anchor bolt shown, from a 12 $\frac{1}{4}$ -in. blank:

**NOTE:** To make another-length bolt, just use a shorter or longer blank. Or, change the dimension given in Step 3 below (being sure that enough material is caught by the block).

See Step 2  
For stop block  
Orientation

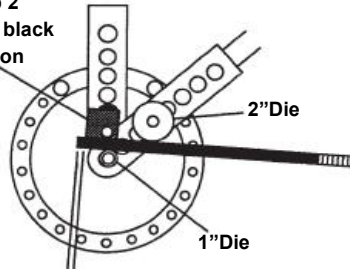

See step 3  
For this dimension.

1. With a long hinge pin, attach the handle and ring loops at their centerpin holes. Install a 1-in. die on the center pin. With the short hinge pin, install a 2-in. die in the handle (#2 hole).
2. With a long hinge pin, install the stop block. Orient the block appropriately for

the diameter of the bolt blank: #2 orientation for  $\frac{3}{8}$ -in. or  $\frac{1}{2}$ -in. bolts; #4 orientation for  $\frac{5}{8}$ -in. bolts.

3. Insert the bolt blank into the Bender so that the unthreaded end extends beyond the stop block:  $\frac{1}{2}$ -in. for  $\frac{3}{8}$ -in. bolts;  $\frac{5}{8}$ -in. for  $\frac{1}{2}$ -in. bolts;  $\frac{1}{4}$ -in. for  $\frac{5}{8}$ -in. bolts.
4. Pull the handle around until the bolt shaft is 90° from the anchor.

### TYPICAL U-BOLTS AND ANCHOR BOLTS

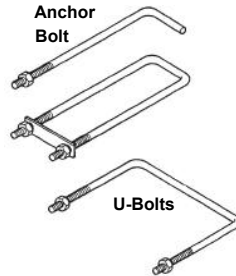

### U-Bolts

The tables on pages 18 and 19 show the appropriate setup for making Ubolts in typical finished lengths and bend radius's, from common diameters of round stock. The illustration below shows the setup for making a U-bolt that is 3 $\frac{1}{2}$ -in. long and 2-in. I.D., using  $\frac{1}{8}$ -in.-diameter stock. For other sizes, adjust the die sizes, stop block orientation, etc., as shown in the tables.

# Model YP-38

## Length

For longer U-bolts, add twice the additional length desired to the "blank length" indicated (for example, to make a U-bolt that is 1 in. longer, add 2 in. to the blank length).

a test bend using unthreaded stock before you make a quantity of U-bolts.

- ◆ Keep a record of die sizes, die positions, and other measurements for future reference.

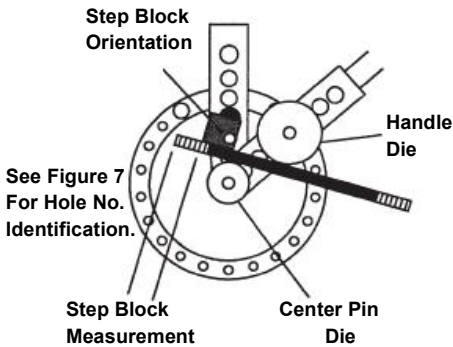

**Typical Setup for Bending  
U-Bolts from Round Stock**

## Bend Radius

Eight bend radius's are possible — by selecting from the seven forming dies, or by using center pin without a die. However to avoid bending the center pin, always use a forming die with round stock larger than  $\frac{3}{8}$ -in. diameter.

## Notes

- ◆ Because blank stock may vary slightly in content or size, we recommend making



# KAKA Industrial®

## Bending U-Bolts from 1/4-in. Round Stock

FINISHED SIZE		SETUP FOR BENDING						
Length	I.D.	Blank Length	Loop Hole No.	Stop Block Orientation	Stop Block Meas't	Center Pin Die	Handle Die	Handle Hole No.
2"	1"	5"	1	#2	Flush	1"	2"	2
2¼"	1¼"	5¼"	1	#2	¼"	1¼"	2"	2
2½"	1½"	6¾"	1	#1	¾"	1½"	2"	2
3"	1¾"	7½"	2	#4	¼"	1¼"	2"	2
3½"	2"	8⅝"	2	#4	⅞"	2"	1¾"	2

## Bending U-Bolts from 1/4-in. Round Stock

FINISHED SIZE		SETUP FOR BENDING						
Length	I.D.	Blank Length	Loop Hole No.	Stop Block Orientation	Stop Block Meas't	Center Pin Die	Handle Die	Handle Hole No.
2½"	1¼"	6¼"	1	#1	⅝"	1¼"	2"	2
3"	1½"	7¾"	2	#4	¼"	1½"	2"	2
3"	1¾"	7⅝"	2	#4	¾"	1¾"	2"	2
3½"	2"	8¾"	2	#4	15/16"	2"	2"	2

## Bending U-Bolts from 3/8-in. Round Stock

FINISHED SIZE		SETUP FOR BENDING						
Length	I.D.	Blank Length	Loop Hole No.	Stop Block Orientation	Stop Block Meas't	Center Pin Die	Handle Die	Handle Hole No.
2½"	1¼"	6½"	1	#1	⅝"	1¼"	2"	2
3"	1½"	7½"	2	#4	7/16"	1½"	3"	3
3"	1¾"	7¾"	2	#4	9/16"	1¾"	3"	3
3"	2"	8"	2	#3	⅛"	2"	3"	3

# Model YP-38

## Bending U-Bolts from 1/2-in. Round Stock

FINISHED SIZE		SETUP FOR BENDING						
Length	I.D.	Blank Length	Loop Hole No.	Stop Block Orientation	Stop Block Meas't	Center Pin Die	Handle Die	Handle Hole No.
2 <sup>3</sup> / <sub>4</sub> "	1 <sup>1</sup> / <sub>2</sub> "	7 <sup>1</sup> / <sub>4</sub> "	2	#4	7/16"	1 <sup>1</sup> / <sub>2</sub> "	3"	3
3"	1 <sup>3</sup> / <sub>4</sub> "	8"	2	#4	15/16"	1 <sup>3</sup> / <sub>4</sub> "	3"	3
3 <sup>1</sup> / <sub>4</sub> "	2"	8 <sup>3</sup> / <sub>4</sub> "	2	#3	3/4"	2"	2 <sup>1</sup> / <sub>2</sub> "	3
4"	2 <sup>1</sup> / <sub>2</sub> "	10 <sup>1</sup> / <sub>8</sub> "	2	#2	1"	2 <sup>1</sup> / <sub>2</sub> "	2"	3
4 <sup>1</sup> / <sub>2</sub> "	3"	11 <sup>5</sup> / <sub>8</sub> "	3	#4	1"	3"	2"	3

## Bending U-Bolts from 5/8-in. Round Stock

FINISHED SIZE		SETUP FOR BENDING						
Length	I.D.	Blank Length	Loop Hole No.	Stop Block Orientation	Stop Block Meas't	Center Pin Die	Handle Die	Handle Hole No.
3 <sup>1</sup> / <sub>2</sub> "	2"	9 <sup>1</sup> / <sub>4</sub> "	2	#2	1"	2"	3"	3
2 <sup>1</sup> / <sub>2</sub> "	2 <sup>1</sup> / <sub>2</sub> "	11 <sup>1</sup> / <sub>2</sub> "	2	#1	1 <sup>5</sup> / <sub>8</sub> "	2 <sup>1</sup> / <sub>2</sub> "	2"	3
5"	3"	12 <sup>3</sup> / <sub>4</sub> "	3	#4	1 <sup>7</sup> / <sub>8</sub> "	3"	2"	3

# KAKA Industrial®

## Example: Bending Letters for Signs



The following pages show how to make all 26 letters of the alphabet, in a typical style. Using the procedure that is shown on these pages results in letters (from  $\frac{3}{16}$ -in. flat stock) which are:

- ◆ 6 in. high
- ◆ 2 in. wide (deep)

### Notes

- ◆ Use only hot-rolled mild steel for forming the letters.
- ◆ Follow the bending steps exactly, and in the sequence given. This is especially important for the letter "S", which is the most difficult to form.
- ◆ To avoid wasting material, practice some of the letters using  $\frac{3}{16}$ -in. stock that is only  $\frac{1}{2}$ -in. wide before you attempt the finished version.
- ◆ If you have two or more identical letters, make all of them before proceeding to a different letter.

### STOCK REQUIRED

- $\frac{3}{16}$ -in. stock; 2-in. max. width
- One 14-in. blank
- One  $3\frac{1}{2}$ -in. blank



### BEND SEQUENCE

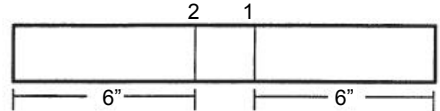

### Setup

Make chalk marks on the 14-in. blank as shown on the "Bend Sequence."

### Bend No. 1

Insert the stock into the Bender to the #6 chalk mark (as in A), and bend it to  $76^\circ$ . Recheck the angle before you go on to the second bend.

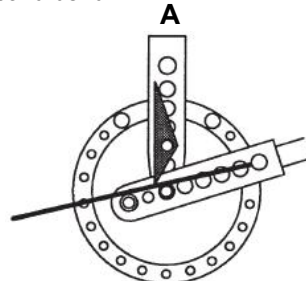

# Model YP-38

## Bend No. 2

Slide the stock to the #15 chalk mark (as in B), and bend it to 76°. Recheck the angle. To remove the part from the Bender, remove the pin that holds the sharp-angle-bend attachment.

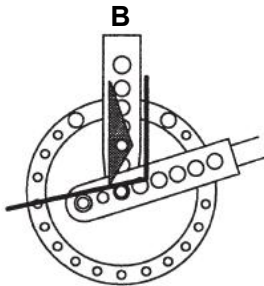

## Finishing

Tack-weld the 3<sup>3</sup>/<sub>16</sub>-in. insert piece between the legs of the "A," parallel to the top edge.

Grind and sand all sharp corners.

## STOCK REQUIRED

3<sup>3</sup>/<sub>16</sub>-in. stock; 2-in. max. width

One 8<sup>7</sup>/<sub>8</sub>-in. blank

One 6-in. blank



## BEND SEQUENCE

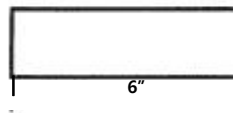
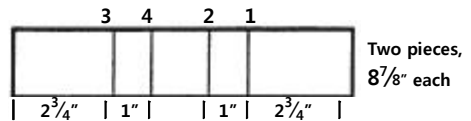

## Setup

Make chalk marks on the two 8<sup>7</sup>/<sub>8</sub>-in. blanks as shown on the "Bend Sequence."

## Bend No. 1

Insert one of the blanks into the Bender to the #6 chalk mark (as in A), and bend it to 45°. Recheck the angle before you go on to the second bend.

Chalk-mark the ring, or set a stop, for ease of repeating the 45° bend.

# KAKA Industrial®

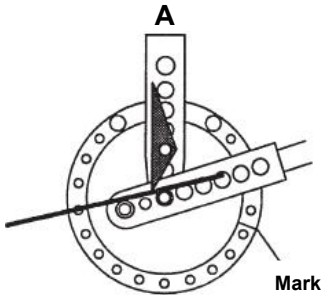

### Bend No. 2

Slide the stock to the #15 chalk mark (as in B), and bend it to 45°. Recheck the angle.

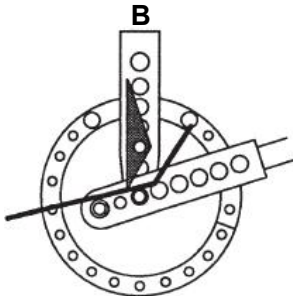

### Bend No. 3

Reverse the stock end-for-end. Slide it to the #24 chalk mark (as in C), and bend it to 45°. Recheck the angle.

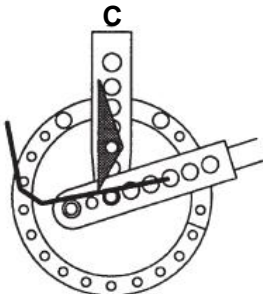

### Bend No. 4

Again reverse the stock end-for-end. Move it to the #10 chalk mark (as in D), and bend it to 45°. Recheck the angle.

To remove the part from the Bender, remove the pin that holds the sharp-angle bend attachment.

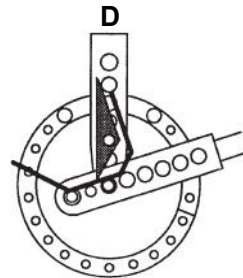

### Finishing

Tack-weld the two loops together. Tack-weld the 6 in. piece to form the back of the letter "B".

Grind and sand all sharp corners.

# Model YP-38

## STOCK REQUIRED

$\frac{3}{16}$ -in. stock; 2-in. max. width

One 14-in. blank

## BEND SEQUENCE

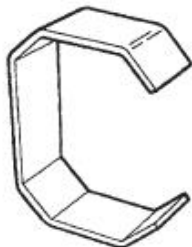
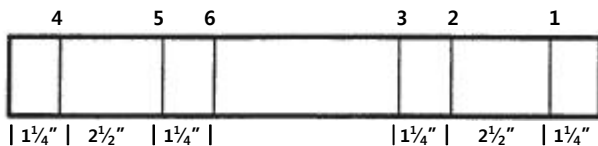

## Setup

Make chalk marks on the 14-in. blank as shown on the "Bend Sequence."

### Bend No. 1

Insert the stock into the Bender to the #6 chalk mark (as in A), and bend it to 45°. Recheck the angle before you go on to the second bend.

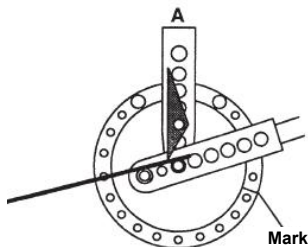

### Bend No. 2

Slide the stock to the #15 chalk mark (as in B), and bend it to 45°. Recheck the angle.

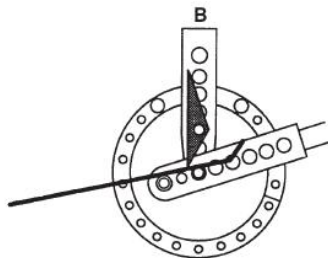

### Bend No. 3

Slide the stock to the #24 chalk mark (as in C), and bend it to 45°. Recheck the angle.

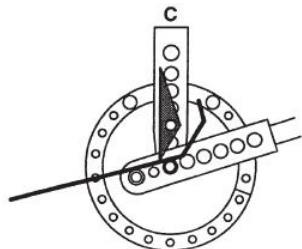

### Bend No. 4

Reverse the stock end-for-end. Slide it to the #10 chalk mark (as in D), and bend it to 45°.

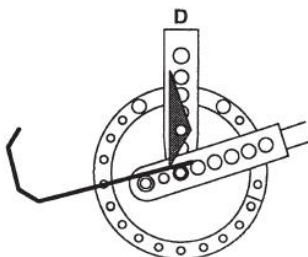

# KAKA Industrial®

## Bend No. 5

Slide the stock to the #16 chalk mark (as in E), and bend it to 45°. Recheck the angle.

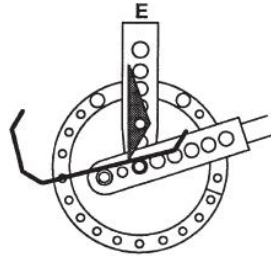

## Bend No. 6

Slide the stock to the #13 chalk mark (as in F), and bend it to 45°.

Recheck the angle.

To remove the part from the Bender, remove the pin that holds the sharpangle-bend attachment.

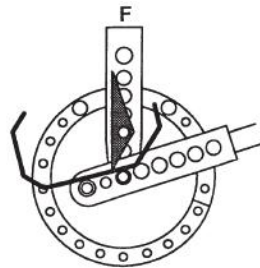

## Finishing

Grind and sand all sharp corners.

### STOCK REQUIRED

$\frac{3}{16}$ -in. stock; 2-in. max. width

One  $12\frac{1}{2}$ -in. blank

One 6-in. blank

### BEND SEQUENCE

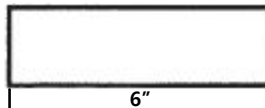
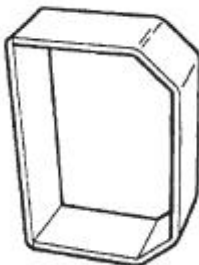
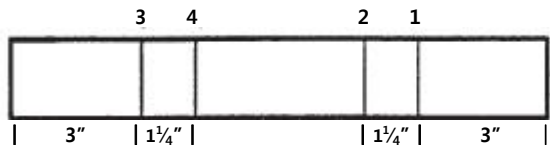

## Setup

Make chalk marks on the two  $12\frac{7}{8}$ -in. blank as shown on the "Bend Sequence."

## Bend No. 1

Insert the blank into the Bender to the #6 chalk mark (as in A), and bend it

# Model YP-38

to 45°. Recheck the angle before you go on to the second bend.

Chalk-mark the ring, or set a stop, for ease of repeating the 45° bend.

## Bend No. 2

Slide the stock to the #15 chalk mark (as in B), and bend it to 45°.

Recheck the angle.

Remove the blank from the Bender. Recheck that the bend leg is at 90° to the front of the "D".

## Bend No. 3

Reverse the stock end-for-end. Slide it to the #24 chalk mark (as in C), and bend it to 45°. Recheck the angle.

## Bend No. 4

Slide the stock to the #10 chalk mark (as in D), and bend it to 45°.

Recheck the angle. Recheck that the two legs are parallel.

To remove the part from the Bender, remove the pin that holds the sharpangle-bend attachment.

## Finishing

Tack-weld the 6 in. piece to form the back of the letter "D".

Grind and sand all sharp corners.

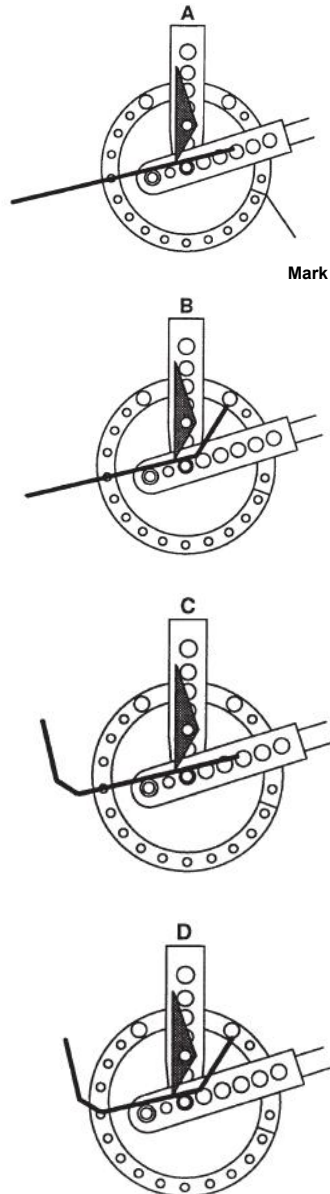



# KAKA Industrial®

**STOCK REQUIRED**

$\frac{3}{16}$ -in. stock; 2-in. max. width

One  $14\frac{9}{16}$ -in. blank

One  $2\frac{1}{2}$ -in. blank

**BEND SEQUENCE**

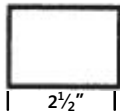
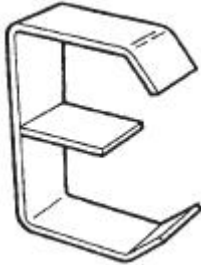
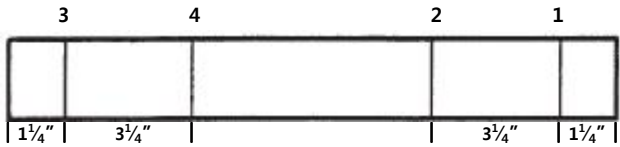

**Setup**

Make chalk marks on the  $14\frac{9}{16}$ -in. blank as shown on the "Bend Sequence."

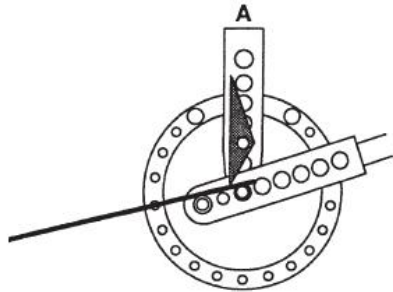

**Bend No. 1**

Insert the blank into the Bender to the #6 chalk mark (as in A), and bend it to 45°. Recheck the angle before you go on to the second bend.

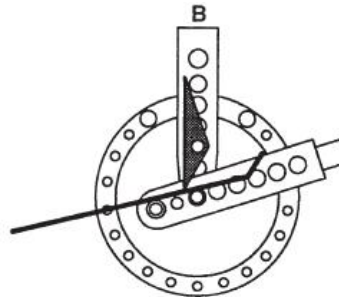

**Bend No. 2**

Slide the stock to the #15 chalk mark (as in B), and bend it to 90°. Recheck the angle.

**Bend No. 3**

Reverse the stock end-for-end. Slide it to the #24 chalk mark (as in C), and bend it to 45°. Recheck the angle.

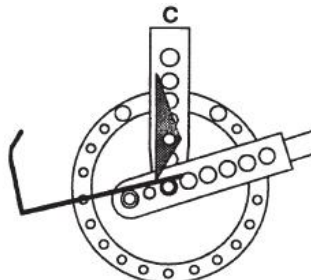

# Model YP-38

## Bend No. 4

Slide the stock to the #10 chalk mark (as in D), and bend it to 90°. Recheck the angle. Check that the top and bottom of the "E" re parallel.

To remove the part from the Bender, remove the pin that holds the sharp-angle-bend attachment.

## Finishing

Tack-weld the 3½-in. insert piece between the legs of the "A," parallel to the top edge.

Grind and sand all sharp corners.

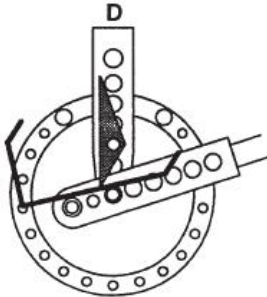

## STOCK REQUIRED

3/16-in. stock; 2-in. max. width

One 10<sup>3</sup>/<sub>8</sub>-in. blank

One 2½-in. blank

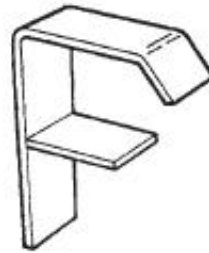

## Setup

Make a letter "L" as shown on page 31.

## Finishing

Position the 2½-in. piece as shown and tack-weld it.

Grind and sand all sharp corners.

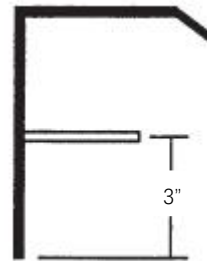

# KAKA Industrial®

**STOCK REQUIRED**

$\frac{3}{16}$ -in. stock; 2-in. max. width

One 14-in. blank

One 3-in. blank

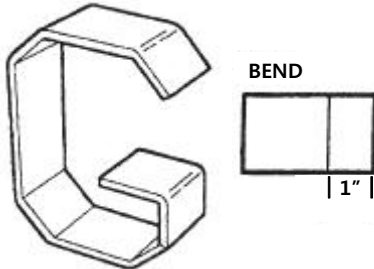

**Setup**

Make a letter "C" as shown on page 23.

Bend Insert the 3-in. blank into the Bender to the chalk mark, and bend it to 90°. Recheck the angle.

To remove the part from the Bender, remove the pin that holds the sharp-angle-bend attachment.

**Finishing**

Position the 3-in. piece as shown and tack-weld it. Grind and sand all sharp corners.

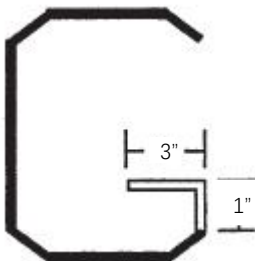

**STOCK REQUIRED**

$\frac{3}{16}$ -in. stock; 2-in. max. width

One 6-in. blank

One  $\frac{3}{4}$ -in. blank

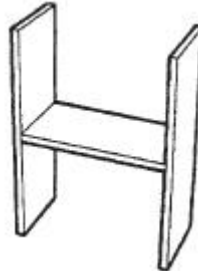

**Setup**

None.

**Finishing**

Tack-weld the pieces together as shown. Recheck that the pieces are at 90° angles to each other.

Grind and sand all sharp corners.

# Model YP-38

## STOCK REQUIRED

$\frac{3}{16}$ -in. stock; 2-in. max. Width

One 5-in. Blank

One  $5\frac{5}{8}$ -in. Blank

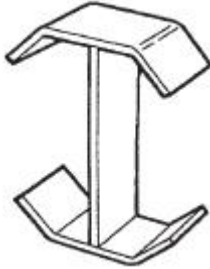

## BEND SEQUENCE(5-in.blanks)

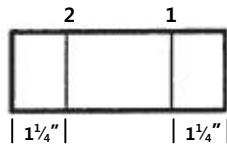

## Finishing

Position the  $5\frac{5}{8}$ -in. piece between the bent pieces as shown and tack-weld it.

Recheck that the parts are  $90^\circ$ .

Grind and sand all sharp corners.

## Setup

Make chalk marks on the 5-in. blanks as shown on the "Bend Sequence."

### Bend No. 1

Insert the blank into the Bender to the #6 chalk mark, and bend it to  $45^\circ$ . Recheck the angle.

Chalk mark the ring, or set a stop, for ease of repeating the  $45^\circ$  bend.

### Bend No. 2

Reverse the stock end-for-end. Slide it to the #15 chalk mark, and bend it to  $45^\circ$ .

Recheck the angle.

To remove the part from the Bender, remove the pin that holds the sharp angle-bend attachment.

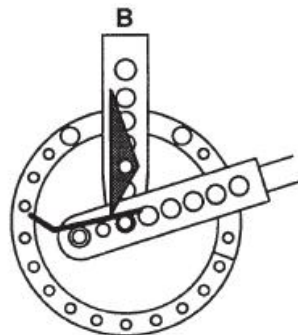
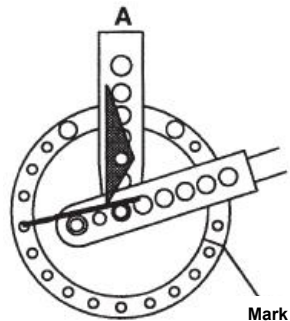

# KAKA Industrial®

## STOCK REQUIRED

$\frac{3}{16}$ -in. stock; 2-in. max. width

One 10-in. blank

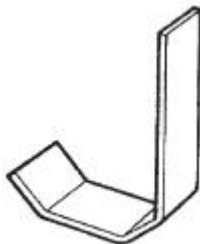

## Setup

Make chalk marks on the blanks as shown on the "Bend Sequence."

### Bend No. 1

Insert the blank into the Bender to the #6 chalk mark, (as in A), and bend it to 45°.

Recheck the angle before you go on to the second bend.

Chalk mark the ring, or set a stop, for ease of repeating the 45° bend.

### Bend No. 2

Slide the stock to the #15 chalk mark (as in B), and bend it to 45°. Recheck the angle.

### Bend No. 3

Slide the stock to the #24 chalk mark (as in C), and bend it to 45°. Recheck the angle.

To remove the part from the Bender,

remove the pin that holds the sharp-angle-bend attachment.

## BEND SEQUENCE

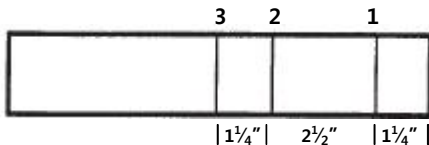

## Finishing

Grind and sand all sharp corners.

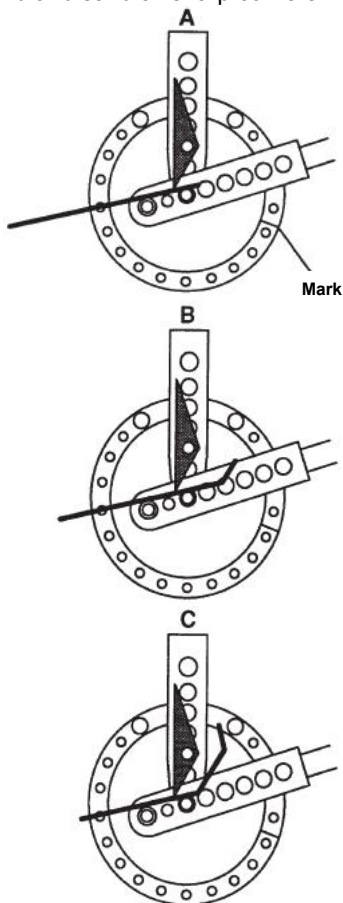

# Model YP-38

**STOCK REQUIRED**

$\frac{3}{16}$ -in. stock; 2-in. max. width

One 7-in. blank

One 6-in. Blank

One  $2\frac{1}{2}$ -in. Blank



**Setup**

Make chalk marks on the 7-in. blanks as shown on the "Bend Sequence."

**Bend**

Insert the blank into the Bender to the chalk mark, and bend until it measures 6 in. as shown.

**Finishing**

Tack-weld the pieces together as shown.

Recheck that the outer tips of the bent

**BEND(7-in.blank)**

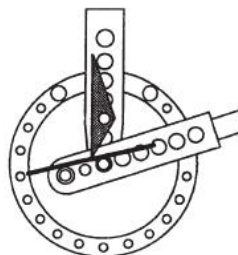
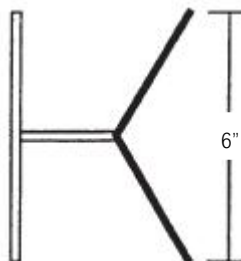
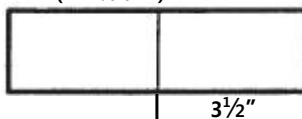

piece are equal distances from the straight piece. Grind and sand all sharp corners.

**STOCK REQUIRED**

$\frac{3}{16}$ -in. stock; 2-in. max. Width

One  $10\frac{3}{8}$ -in. Blank

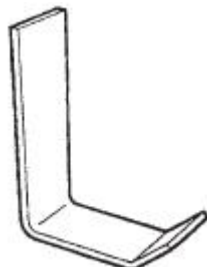

**BEND SEQUENCE**

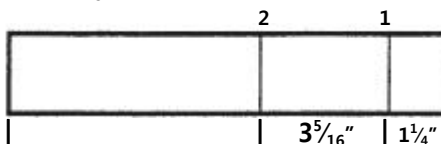

**Setup**

Make chalk marks on the blanks as shown on the "Bend Sequence."

# KAKA Industrial®

## Bend No. 1

Insert the blank into the Bender to the #6 chalk mark, and bend it to 45°. Recheck the angle.

## Bend No. 2

Slide the stock to the #15 chalk mark, and bend to 90°.

Recheck the angle.

To remove the part from the Bender, remove the pin that holds the sharpangle-bend attachment.

## Finishing

Grind and sand all sharp corners.

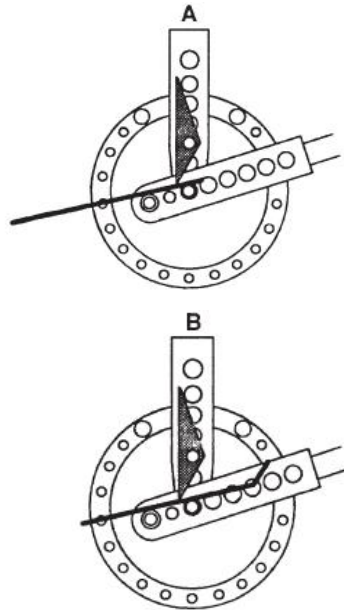

### STOCK REQUIRED

$\frac{3}{16}$ -in. stock; 2-in. max. width

One 13 $\frac{1}{2}$ -in. blank

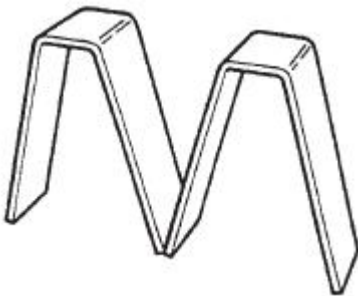

## Setup

Make two letter "V"s.

## Finishing

Turn the "V"s upside-down, and tack-weld them together as shown.

Check that the three bottom tips are aligned.

Grind and sand all sharp corners.

# Model YP-38

## STOCK REQUIRED

$\frac{3}{16}$ -in. stock; 2-in. max. width

One  $\frac{8}{16}$ -in. Blank

Two 6-in. Blanks



## BEND SEQUENCE ( $\frac{8}{16}$ -in. Blank)

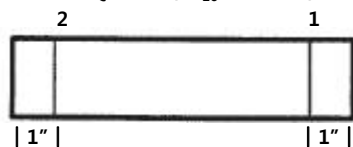

To remove the part from the Bender, remove the pin that holds the sharp-angle-bend attachment.

## Finishing

Tack-weld the pieces together. Recheck that the straight legs are parallel.

Grind and sand all sharp corners.

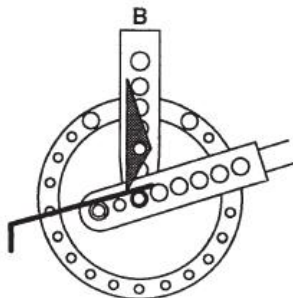
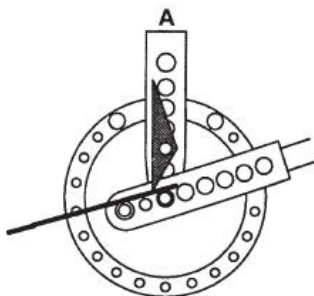

## Setup

Make chalk marks on the  $\frac{8}{16}$ -in. blanks as shown on the "Bend Sequence."

### Bend No. 1

Insert the blank into the Bender to the #6 chalk mark, (as in A), and bend it to 73°.

Recheck the angle.

### Bend No. 2

Reverse the stock end-for-end. Slide it to the #15 chalk mark, and bend it to 73°.

Recheck the angle.



# KAKA Industrial®

**STOCK REQUIRED**

$\frac{3}{16}$ -in. stock; 2-in. max. width

One 14-in. blank

One  $3\frac{7}{8}$ -in. blank

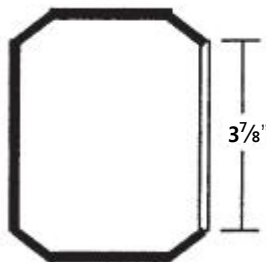
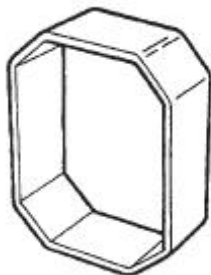

**Setup**

Make a letter "C" from the 14-in. blank as shown on page 23.

**Finishing**

Tack-weld the two pieces together as shown.

Grind and sand all sharp corners.

**STOCK REQUIRED**

$\frac{3}{16}$ -in. stock; 2-in. max. width

One  $8\frac{7}{8}$ -in. blank

One 6-in. blank

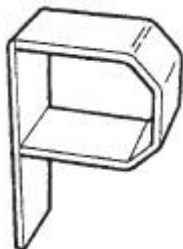

**Setup**

Make part of a letter "B" (page 21)—the straight piece and one loop.

**Finishing**

Tack-weld the pieces together.

Grind and sand all sharp corners.

# Model YP-38

**STOCK REQUIRED**

$\frac{3}{16}$ -in. stock; 2-in. max. width

One 14-in. blank

One  $3\frac{7}{8}$ -in. blank

One 2-in. blank

One  $\frac{3}{4}$ -in. blank

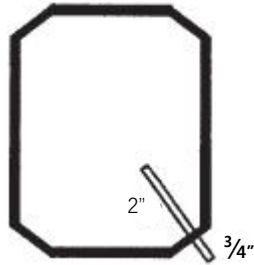
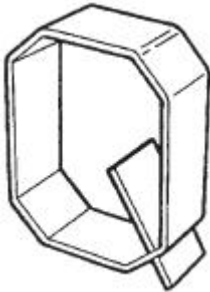

**Setup**

Make a letter "O" (above).

**Finishing**

Tack-weld the short pieces to the "O" as shown above.

Grind and sand all sharp corners.

**STOCK REQUIRED**

$\frac{3}{16}$ -in. stock; 2-in. max. width

One  $8\frac{7}{8}$ -in. blank

One 6-in. blank

One  $3\frac{1}{8}$ -in. blank

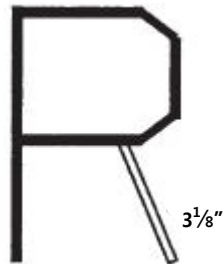

**Setup**

Make part of a letter "P" .

**Finishing**

Tack-weld the  $3\frac{1}{8}$ -in. piece to the "P" as shown.

Grind and sand all sharp corners.

# KAKA Industrial®

**STOCK REQUIRED**

$\frac{3}{16}$ -in. stock; 2-in. max. Width

One 16 $\frac{1}{2}$ -in. blank

**BEND SEQUENCE**

5    6    9    8    7            3    4    10    2            1

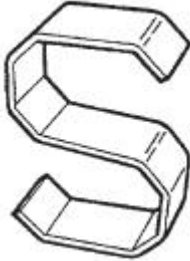
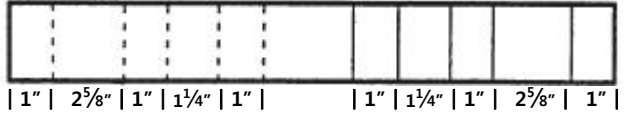

**CAUTION:** Because of the number of bends, it is especially important to check all bend angles carefully when making the letter "S."

**Setup**

Make chalk marks on the blank as shown on the "Bend Sequence."

Note that the five chalk marks on one end of the blank must be on the opposite face from the five marks on the other end.

**Bend No. 1**

Insert the blank into the Bender to the #6 chalk mark (as in A), and bend it to 45°.

Recheck the angle.

Chalk-mark the ring, or set a stop, for ease of repeating the 45° bend. (Note that Bends #24 and #27 are to 41°.)

**Bend No. 2**

Slide the blank to the #15 chalk mark (as in B), and bend it to 45°.

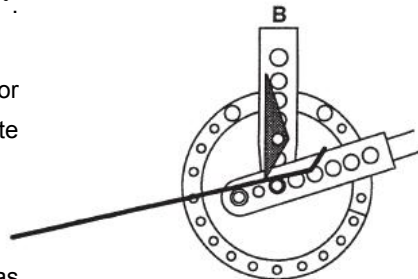
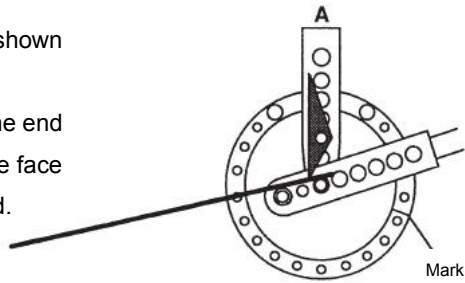

# Model YP-38

## Bend No. 3

Slide the blank to the #24 chalk mark (as in C), and bend it to 41°. Recheck the angle.

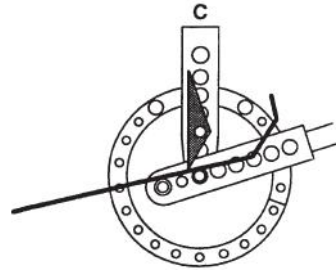

## Bend No. 4

Slide the blank back to the #10 chalk mark (as in D), and bend it to 45°.

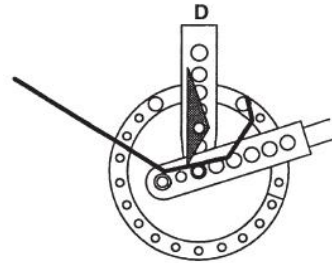

## Bend No. 5

Reverse the stock end-for-end. Slide the blank to the #16 chalk mark (as in E), and bend it to 45°. Recheck the angle.

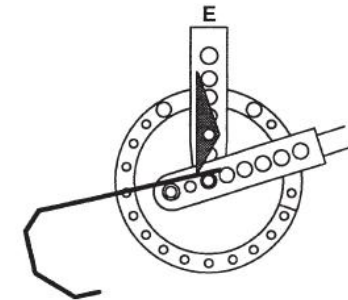

## Bend No. 6

Slide the blank back to the #13 chalk mark (as in F), and bend it to 45°. Recheck the angle.

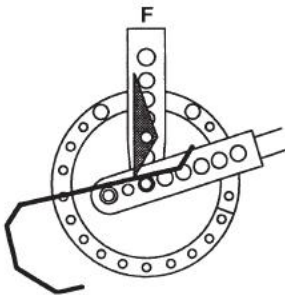

## Bend No. 7

Slide the blank to the #27 chalk mark (as in G), and bend it to 41°. Recheck the angle.

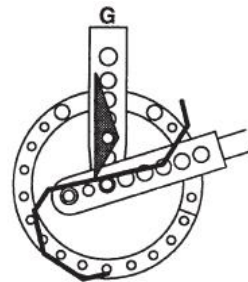

# KAKA Industrial®

## Bend No. 8

Slide the blank back to the #14 chalk mark (as in H), and bend it to 45°. Recheck the angle.

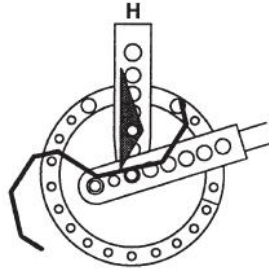

## Bend No. 9

Reverse the stock end-for-end. Pull the pin in the sharp-angle-bend attachment to allow space for the blank. Insert the blank, and reinstall the pin.

Slide the blank to the #1 chalk mark (as in I), and bend it to 45°. Recheck the angle.

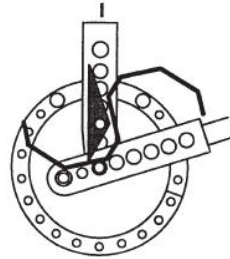

## Bend No. 10

Again reverse the stock end-for-end. Slide the blank to the #3 chalk mark (as in J), and bend it to 45°. Recheck the angle, and check that the top and bottom of the "S" are parallel.

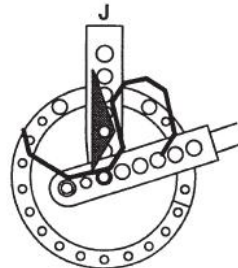

### STOCK REQUIRED

$\frac{3}{16}$ -in. stock; 2-in. max. Width

One 6-in. blank

One  $5\frac{1}{16}$ -in. blank



### BEND SEQUENCE ( $5\frac{13}{16}$ -in. blank)

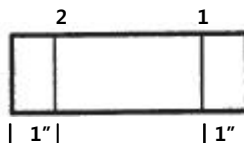

### Setup

Make chalk marks on the  $5\frac{13}{16}$ -in. blank as shown on the "Bend Sequence."

# Model YP-38

## Bend No. 1

Insert the blank into the Bender to the #6 chalk mark (as in A), and bend it to 45°.

Recheck the angle.

Chalk mark the ring, or set a stop, for ease of repeating the 45° bend.

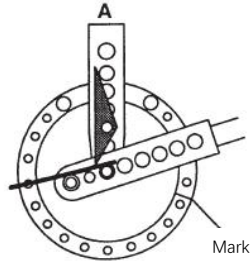

## Bend No. 2

Reverse the stock end-for-end. Slide it to the #15 chalk mark (as in B), and bend it to 45°. Recheck the angle.

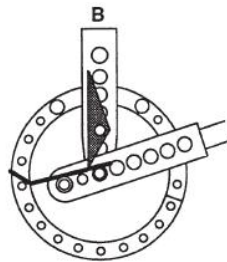

## Finishing

Grind and sand all sharp corners.

### STOCK REQUIRED

$\frac{3}{16}$ -in. stock; 2-in. max. Width  
One  $14\frac{3}{4}$ -in. blank

### BEND SEQUENCE

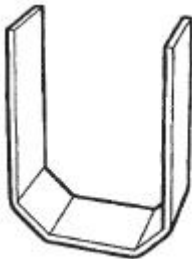
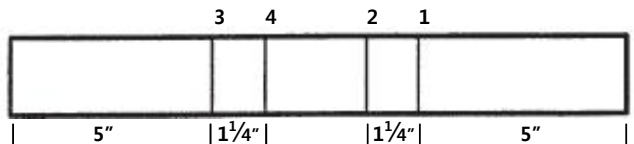

## Setup

Make chalk marks on the blank as shown on the "Bend Sequence."

## Bend No. 1

Insert the blank into the Bender to the #6 chalk mark,(as in A), and bend it to 45°.

Recheck the angle.

Chalk-mark the ring, or set a stop, for ease of repeating the 45° bend.

## Bend No. 2

Slide the blank to the #15 chalk mark (as in B), and bend it to 45°. Recheck the angle.

## Bend No. 3

Reverse the stock end-for-end. Slide it to

# KAKA Industrial®

the #24 chalk mark (as in C), and bend it to 45°. Recheck the angle.

### Bend No. 4

Slide the stock to the #10 chalk mark (as in D), and bend it to 45. Recheck the angle, and check that the legs of the "U" are parallel.

### Finishing

Grind and sand all sharp corners.

### Setup

Make chalk marks on the 5<sup>13</sup>/<sub>16</sub>-in. blank as shown on the "Bend Sequence."

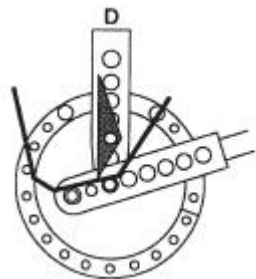
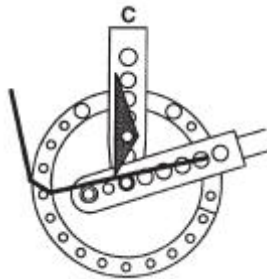
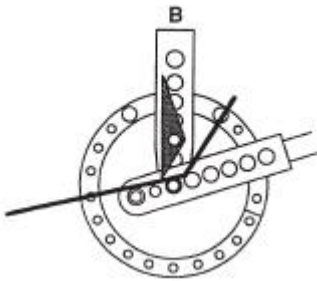
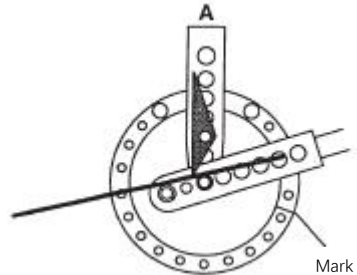

### STOCK REQUIRED

3/16-in. stock; 2-in. max. Width  
One 13 1/2-in. blank

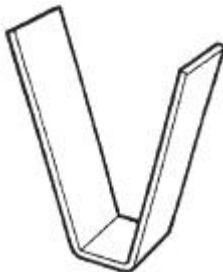

### BEND SEQUENCE

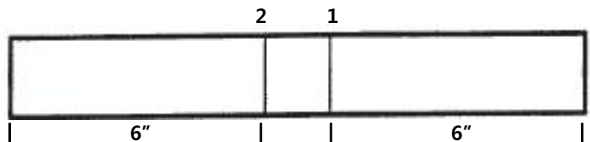

### Bend No. 1

Insert the blank into the Bender to the #6 chalk mark (as in A), and bend it to 75°.

### Bend No. 2

Slide the blank to the #15 chalk mark (as in B), and bend it to 75°. To remove the

# Model YP-38

part, pull the pin in the sharp-angle-bend attachment.

## Finishing

Grind and sand all sharp corners.

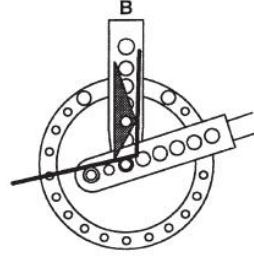
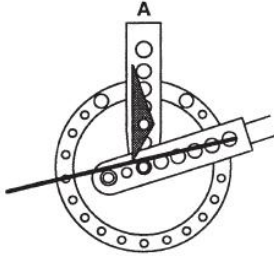

### STOCK REQUIRED

$\frac{3}{16}$ -in. stock; 2-in. max. width

Two  $1\frac{1}{2}$ -in. blank

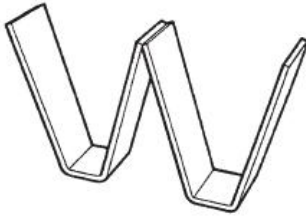

Make the letter "W" by tack-welding together two letter "V"s (the same as a letter "M").

### STOCK REQUIRED

$\frac{3}{16}$ -in. stock; 2-in. max. width

Two  $7\frac{1}{2}$ -in. blanks

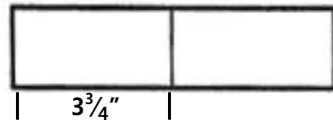

## Bend

Insert the blank into the Bender to the chalk mark, and bend it until the outside dimension is 6 in. (as shown).

## Finishing

Tack-weld the two pieces together. Check that the parts are parallel.

Grind and sand all sharp corners.

## Setup

Make chalk marks on the blank as shown on the "Bend Sequence."



# KAKA Industrial®

## STOCK REQUIRED

$\frac{3}{16}$ -in. stock; 2-in. max. Width

One  $9\frac{1}{2}$ -in. blank

One  $3\frac{3}{4}$ -in. blank



## BEND SEQUENCE ( $9\frac{1}{2}$ -in. blank)

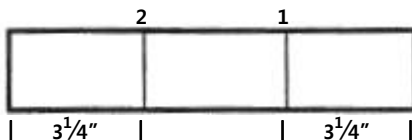

## Setup

Make chalk marks on the blank as shown on the "Bend Sequence."

### Bend No. 1

Insert the blank into the Bender to the #6 chalk mark (as in A), and bend it to  $80^\circ$ .

Recheck the angle.

### Bend No. 2

Slide the stock to the #1 chalk mark (as in B), and bend it to  $80^\circ$ . Recheck the angle.

To remove the part, pull the pin from the sharp-angle-bend attachment.

## Finishing

Grind and sand all sharp corners.

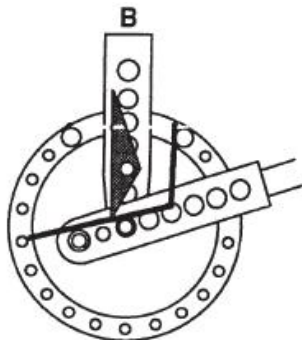
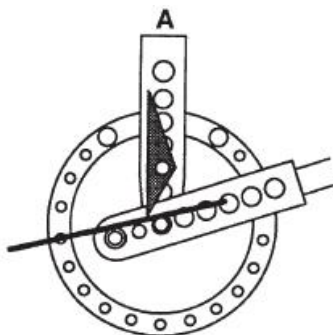

# Model YP-38

## STOCK REQUIRED

$\frac{3}{16}$ -in. stock; 2-in. max. Width

One  $13\frac{1}{2}$ -in. blank

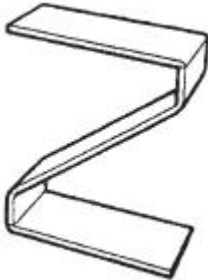

## BEND SEQUENCE ( $7\frac{1}{2}$ -in. blank)

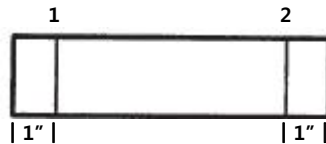

## Setup

Make chalk marks on the  $7\frac{1}{2}$ -in. blank as shown on the "Bend Sequence."

### Bend No. 1

Insert the blank into the Bender to the #6 chalk mark (as in A), and bend it to  $50^\circ$ .

Recheck the angle.

### Bend No. 2

Reverse the part end-for-end. Slide it to the #15 chalk mark (as in B), and bend it to  $50^\circ$ .

## Finishing

Tack-weld the bent piece to the two  $4\frac{1}{2}$ -in. pieces. The legs of the "Z" should be parallel, 6 in. apart. Grind and sand all sharp corners.

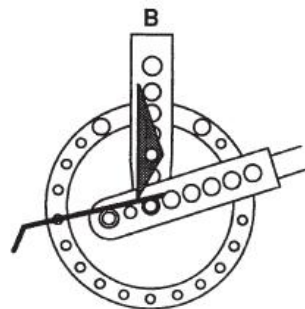
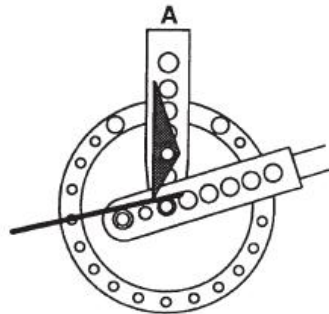

# KAKA Industrial®

## Parts List

Part #	Description	Qty
1	Long Hitch Pin	2
2	Short Hitch Pin	1
3	Stop Block	1
4	Block Support	1
5	Fixed Stop	1
6	Loop Spacer	1
7	Sharp-Angle-Bend Attachment	1
8	Handle Extension Arm	1
9	Handle	1
10	Ring Assembly	1
11	Stand	1
12	Handle Pin with Hair Clip	1
13	Ring Spacer	3
14	Nut M10 mm	4
15	Bolt M10x120mm	1
16	Flat-head Bolt M10x35mm	2
17	Die 1-in	1
18	Die 1¼-in	1
19	Die 1½-in	2
20	Die 1¾-in	1
21	Die 2-in	1
22	Die 2½-in	1
23	Die 3-in	1
24	Flat Washer 10mm	4
25	Bolt M10x35mm	1
26	Adjustable Stop	1
27	Spring Washer	4

# Model YP-38

## Parts Diagram

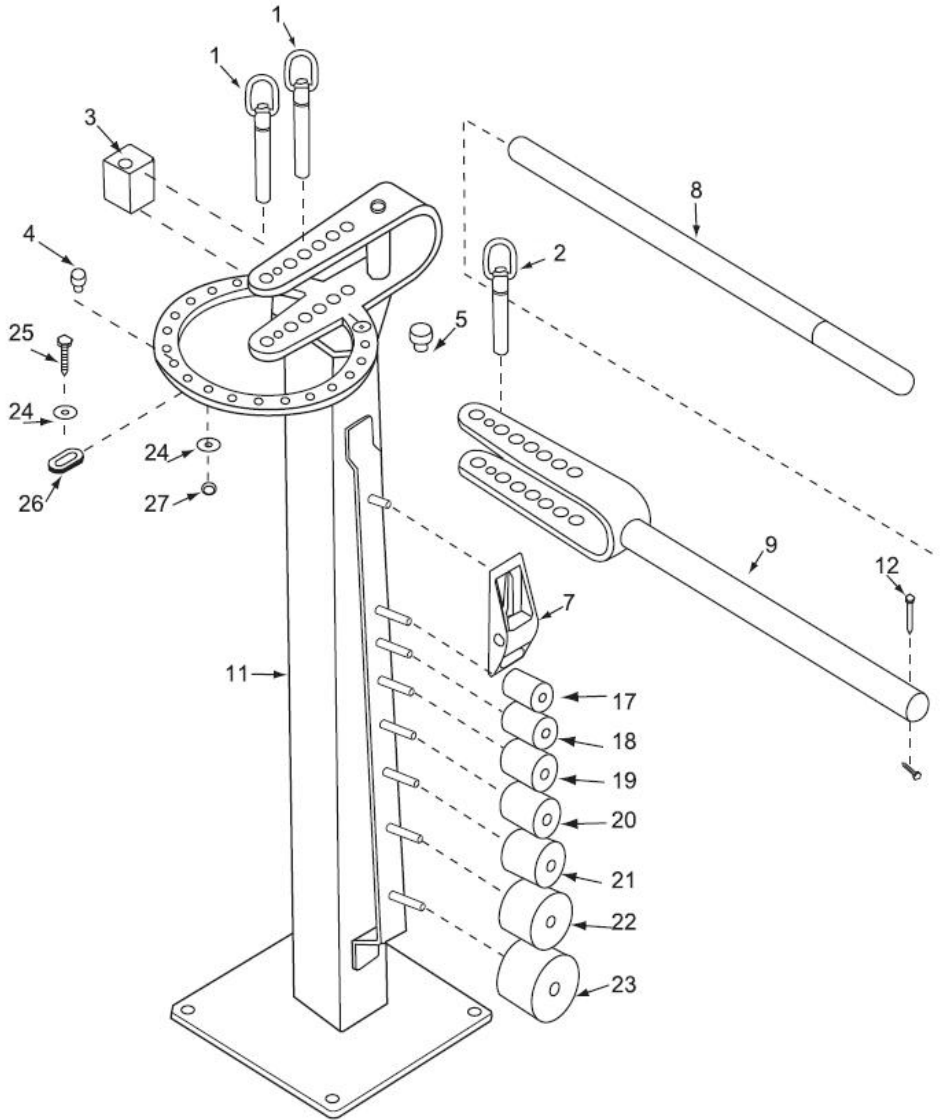

# KAKA Industrial®

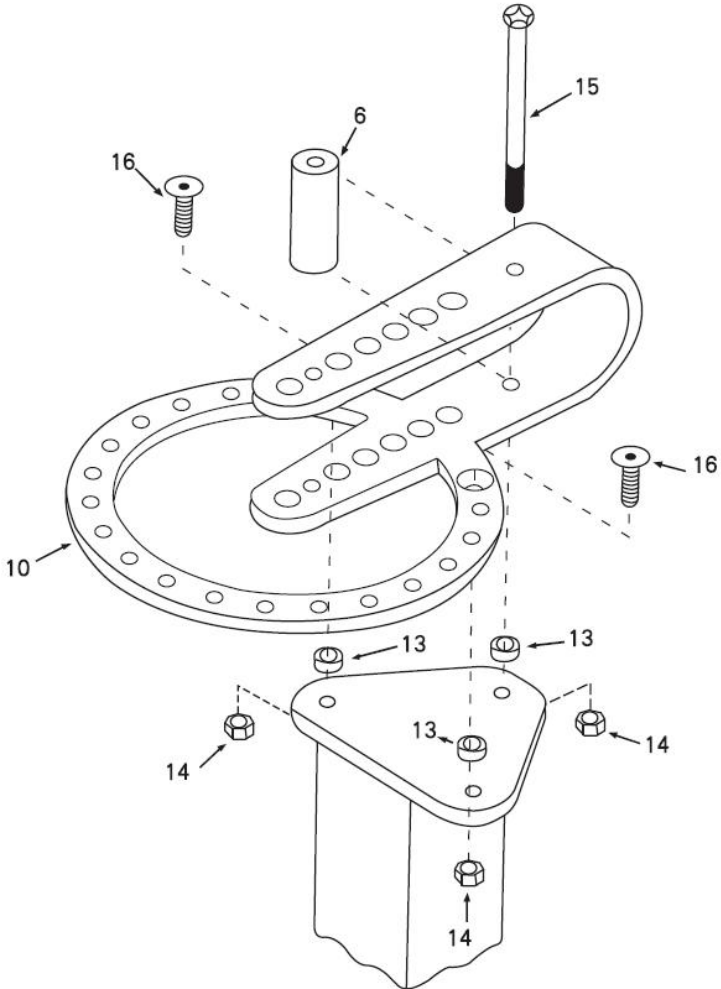





Stock No: 173214  
Edition 1 04/2018  
Copyright © 2018 KAKA



---

If you have any questions about the use of this product, please contact the nearest one to you as below:

**KAKA INDUSTRIAL LLC**

Mail:

[info@kakaindustrial.com](mailto:info@kakaindustrial.com)

Add: 4200 Steve Reynolds

Blvd Ste 6 Norcross,

GA 30093

U.S.A.

**KAKA INDUSTRIAL LTD**

Mail:

[echo@kakaindustrial.com](mailto:echo@kakaindustrial.com)

Add: 3143 Underhill Avenue

Burnaby,

B.C V5A3C8

Canada

**KANG INDUSTRIAL PTY LTD**

Mail:

[kang@kakaindustrial.com](mailto:kang@kakaindustrial.com)

Add: 3 Wayne Court

Dandenong,

VIC 3175

Australia