



VARAN Tisch / Table

Design: Gil Coste, 2010

Brettverleimte, durchlaufende Massivholzplatte. Plattenstärke: 2,8 cm. Oberflächen geölt und gewachst oder matt lackiert, siehe Holzmuster. Untergestell aus Massivholz. Der Fuß sollte für zusätzliche Stabilität mit Sand gefüllt werden. Bei Zwischenmaßen nehmen Sie bitte den nächsthöheren Preis. Tischhöhe: 74,5 cm.

Glued and laminated continuous solid wood tabletop, Top thickness: 2,8 cm. Surface oiled and waxed or matt varnished, see wood samples. Base made of solid wood. The foot should be filled with sand for extra stability. For intermediate sizes please take the next higher price. Table height: 74,5 cm.

VARAN rechteckig, Maserung längslaufend VARAN rectangular, grain lengthwise

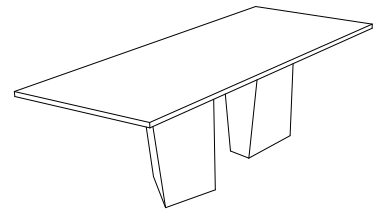
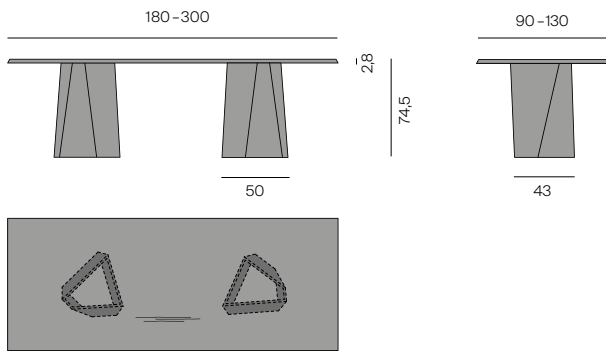

Frei positionierbares Untergestell Freely positionable base

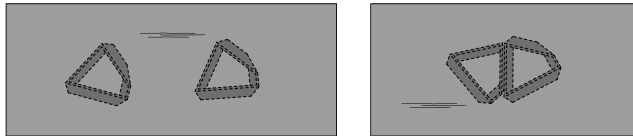

VARAN rund VARAN round

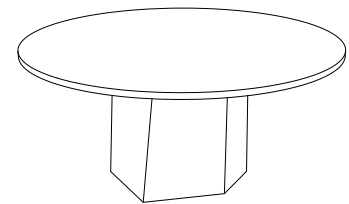
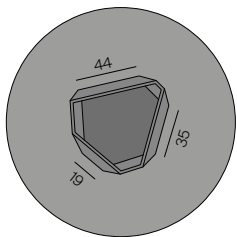
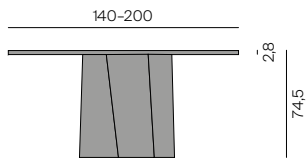

Plattenquerschnitt Cross-section tabletop

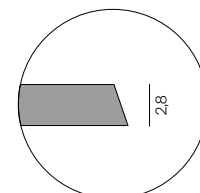

VARAN, Maserung längslaufend
 VARAN, grain lengthwise

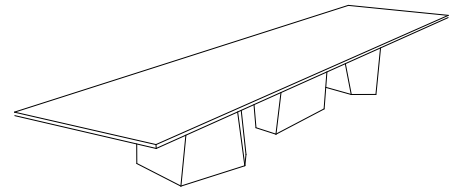
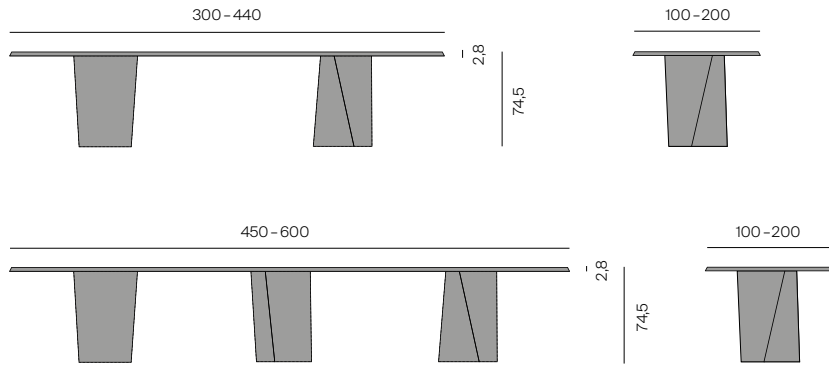

Untergestellgrößen - die Untergestelle sind frei positionierbar
 Base sizes - free choice of base position

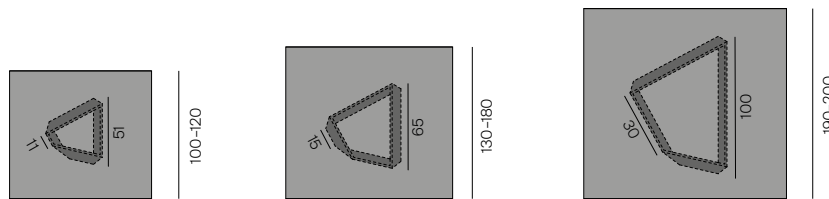

Plattenquerschnitt
 Cross-section tabletop

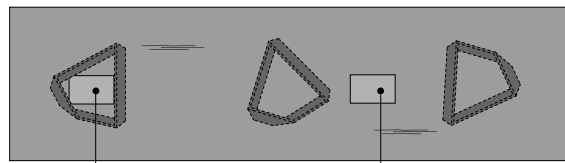
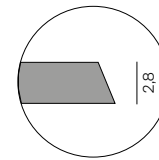

Kabelklappe (optional)
 Cable flap (optional)

Kabelklappe
 Cable flap

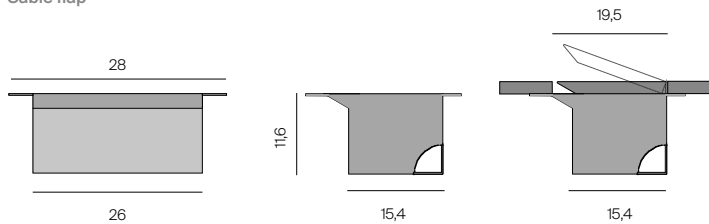

Kabeldurchführung
 Grommet

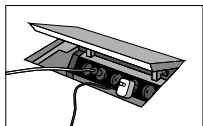
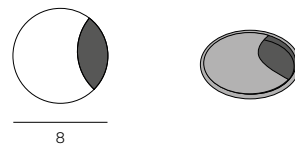

Bestückung separat erhältlich unter: <http://www.evoline.com>
 Matching equipment available separately via: <http://www.evoline.com>

Revisionsklappe
 Revision flap

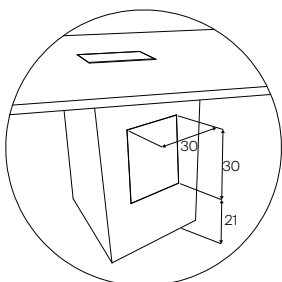

Bitte beachten Sie: Bei einer Breite von 100-120 cm erhalten Sie den VARAN Tisch mit Medienbox im Fuß nur mit dem größeren Untergestell.
 Please note: For widths of 100-120 cm, the VARAN table with media box in the base is only available with the larger base frame.