

Tiki stools

© design by Dirk Wynants



Dimensions

The Tiki stool is available in 2 versions

Powder coated seat with drainage hole / oak seat (for indoor use only)

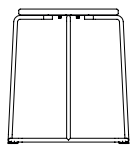
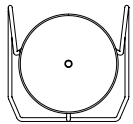

447

ø340

413

392

The Tiki counter stool is available in 2 versions

Powder coated seat with drainage hole / oak seat (for indoor use only)

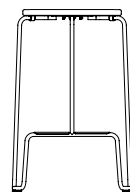
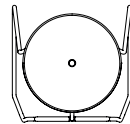

627

204

ø340

413

410

The Tiki bar stool is available in 2 versions

Powder coated seat with drainage hole / oak seat (for indoor use only)

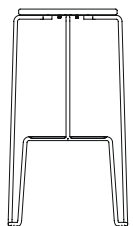
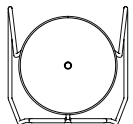

737

314

ø340

413

410

Tiki stools - Technical sheet

Box dimensions

The Tiki stools comes in 2 boxes

Box 1: Legs

Max volume: **up to 4 legs per box**

Stool: 0,13 m³ | Gross weight: 16,50 kg | Net weight: 14,80 kg

Counter stool: 0,17 m³ | Gross weight: 19,10 kg | Net weight: 17,40 kg

Bar stool: 0,19 m³ | Gross weight: 21,70 kg | Net weight: 20,00 kg

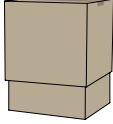

Box 2: Seats

Max volume: **up to 4 seats per box**

0,03 m³ | Gross weight: 8,20 kg | Net weight: 7,60 kg



Box dimensions (mm)		L	W	H	Qty	Volume (m ³)	Gross weight (kg)	Net weight (kg)	Packaging weight (kg)
Tiki stool	Box 1	520	460	530	1	0,13	5,40	3,70	1,70
	Box 2	370	370	215	1	0,03	2,50	1,90	0,60
					total:	0,16	7,90	5,60	2,30
Tiki counter stool	Box 1	520	460	640	1	0,15	6,05	4,35	1,70
	Box 2	370	370	215	1	0,03	2,50	1,90	0,60
					total:	0,18	7,55	6,25	2,30
Tiki bar stool	Box 1	520	460	755	1	0,18	6,70	5,00	1,70
	Box 2	370	370	215	1	0,03	2,50	1,90	0,60
					total:	0,21	8,20	6,90	2,30

Tiki stools - Technical sheet

Backrest

The backrest is available in 1 dimension

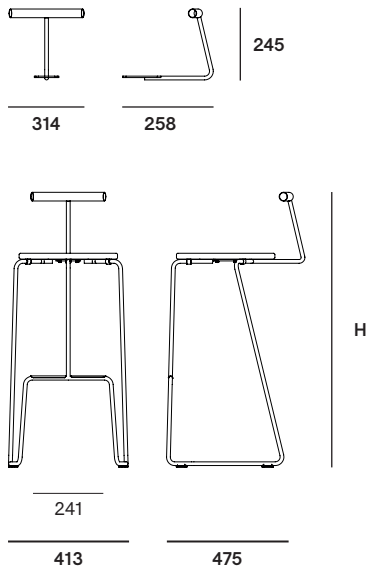

Backrest box

The backrest comes in 1 box

Box 3: backrest

Max volume: **up to 4 backrests per box**

0,03 m³ | Gross weight: 5,40 kg | Net weight: 4,80 kg



Dimensions (mm)	H
Backrest on stool	653
Backrest on counter stool	838
Backrest on bar stool	949

Box dimensions (mm)		L	W	H	Qty	Volume (m ³)	Gross weight (kg)	Net weight (kg)	Packaging weight (kg)
Backrest - 1 piece	Box 3	370	370	215	1	0,03	1,80	1,20	0,60

Tiki stools - Technical sheet

Cushion

The cushion is available in 1 dimension

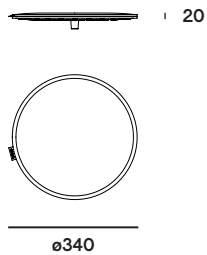

Cushion bag

The cushion comes in 1 bag

Bag 1: cushion

The cushions are delivered inside the box with the legs

0,31 kg/pc

Materials & colors

Check price list or www.extremis.com for current materials & colors

Legs & backrest

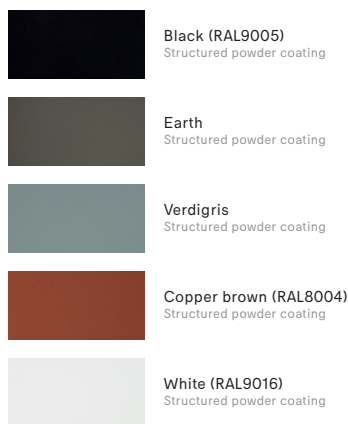

Seats

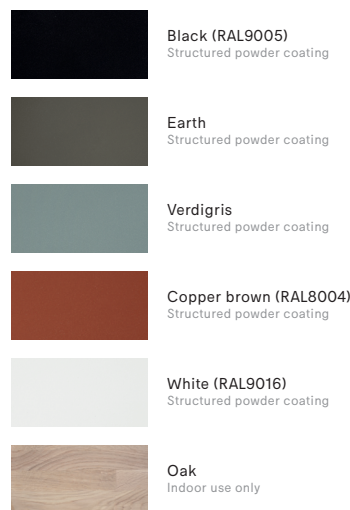

Sunbrella® cushions

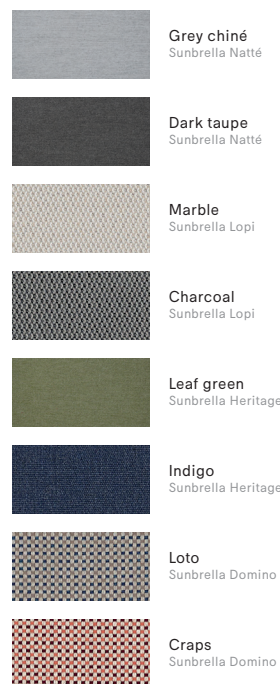

Materials	Key facts	Thickness mm	Layer thickness micron	Density	In/outdoor	Water	UV color fastness	Flame retarding
Structured powder coated steel legs & backrest	<ul style="list-style-type: none"> Easy to clean Cold galvanised, then powder-coated More scratch-resistant than non structured powder coating 	12	100	7,50 10 ³ kg/m ³	Outdoor & indoor	n.a.	Very good: color can fade to some extent when exposed to UV	NEN-EN13501-1 A1 *
Structured powder coated ZnAlMg steel seats	<ul style="list-style-type: none"> A technique of applying dry paint to a part Electrostatically charged and sprayed onto the object More scratch-resistant than non structured powder coating 	1,50	60	7,50 10 ³ kg/m ³	Outdoor & indoor	n.a.	Very good: color can fade to some extent when exposed to UV	NEN-EN13501-1 A2-s1 **
Oak seat	<ul style="list-style-type: none"> Oiled Feels comfortable in all indoor conditions 	30	n.a.	8,00 10 ³ kg/m ³	Indoor use only	n.a.	n.a.	/
Stainless steel foot rest	<ul style="list-style-type: none"> High rust resistance Periodical maintenance required 	12	n.a.	8,00 10 ³ kg/m ³	Outdoor & indoor	n.a.	No effect	NEN-EN13501-1 A1 *
Sunbrella® cushions	<ul style="list-style-type: none"> 100% Sunbrella Acrylic Best outdoor fabric available for making cushions Dirt repellent Not waterproof, store inside! Machine washable at max. 30°C. Ironing restores the protective layer 	0,50	n.a.	260 g/m ²	Outdoor & indoor	The fabric has a water column of 350 mm (EN 20811)	7/8 (ISO 105-B02)	/

NEN-EN13501-1 A1

Class A1 products will not contribute to fire in any stage, including fully developed fire. For this reason, they are assumed to be capable of satisfying all requirements of all lower classes as well.

NEN-EN13501-1 A2-sl

Satisfying the same criteria as class B for the SBI-test according to EN 13823. In addition, under conditions of a fully developed fire these products will not significantly contribute to the fire load and fire growth

Good to know

- Transparent fine lines, to give bars, kitchens, etc., a tidy, sleek look with its minimal impact.
- Footrest with great freedom of movement.
- Water draining seat for powder-coated seats.
- Stackable.



Stackable up to 8 pieces



Stackable with backrest



Tiki bar stools
with Tiki table 3-people



Tiki bar stools
with Tiki table 5-people



Tiki bar stools
with Pantagruel high table



Tiki bar stools
with Marina high table

Maintenance

POWDER COATED PARTS

- White powder coating obviously requires more maintenance.
- Clean stains with a magic eraser.

SUNBRELLA

- Shake or brush off loose dirt immediately.
- Spray Extremis Multi Cleaner.
- Use a soft brush and make circular movements.
- Let the suds soak in for a moment.
- Rinse thoroughly to remove all soap residue.
- Simply allow to dry.
- It's also possible to put the blanket and the pillow covers in a washing machine (max 40°C). Follow the cleaning instruction on the label.

Protection feet with felt

- Tiki has optional protection feet with felt for delicate floors.

F.A.Q.

Q: Is it possible to stack the tiki?

A: It is possible. You can stack Tiki up to 8 pieces.

Q: Are the stools weatherproof?

A: Yes, except for the version with oak seat. The seat and legs of the Tiki stools are made of durable, UV- & waterproof materials. The hole in the seat makes sure the water can evacuate easily.

Warnings

General

- Do not use any sharp tools to open the packaging.
- We strongly advise against using power tools.
- Tripping hazard, mind your step.
- Do not put out cigarettes on the stool.
- Not graffiti proof.
- Do not leave children unattended whilst playing on the stool.
- To avoid danger of suffocation, keep plastic bags away from babies and children.
- Colors can differ over years and from batch to batch.

Product

- Do not lean forwards or backwards, always stay on 4 feet.
- Stackable up to 8 pieces.
- Max. 1 person or 120 kg per seat.
- The stools are weatherproof, except for the version with oak seat.
- Do not stand on the stools.
- Store the cushions indoor when not used.

Powder coating

- White powder coating requires more maintenance.
- Do not use abrasive scouring powders or scourers as they will scratch the surface.
- Color can fade to some extent when exposed to UV.
- Flame retarding - NEN-EN13501-1 A2-sl - Satisfying the same criteria as Class B for the SBI-test according to EN13823. In addition, under conditions of a fully developed fire these products will not significantly contribute to the fire load and fire growth.
- Dark colors can get very hot in sunny weather.

Wood

- When delivered, the wood is oiled.
- Wood is a natural material and its look is different for every slat, plank and tree.
- Clean regularly with mild detergent. Never use a high pressure cleaner as this will roughen the wood's smooth surface and irreparably damage the wood's fiber.

Sunbrella®

- Not waterproof, store inside!
- Shake or brush off loose dirt immediately.
- UV color fastness: 7/8 (ISO 105-B02).