

Chairs
Tables
Benches
Tables extra high
Bench extra high

Floor fastening
Cushions

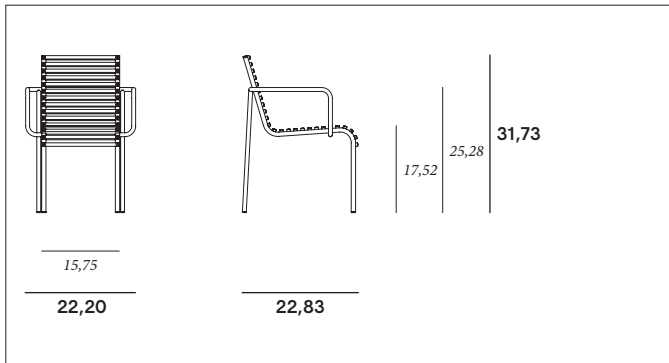

Chair



Low chair high back

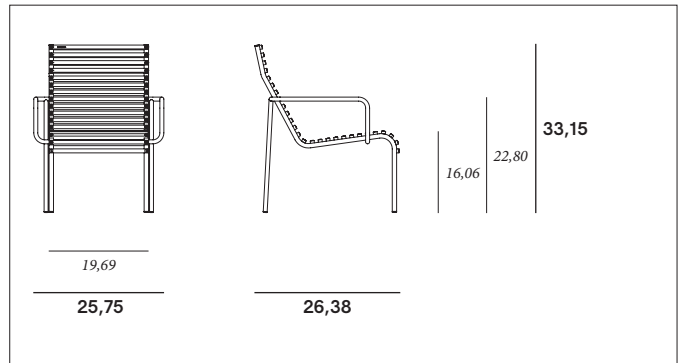

Lounge chair

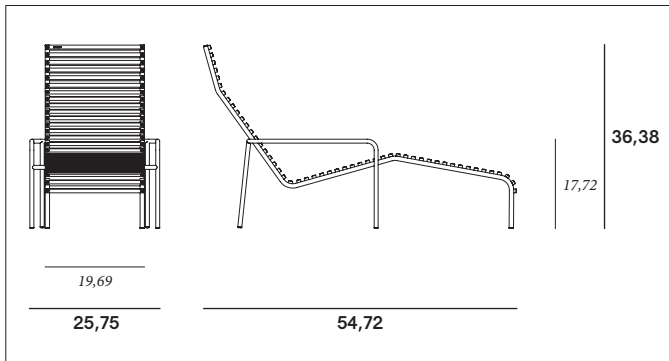

Footrest

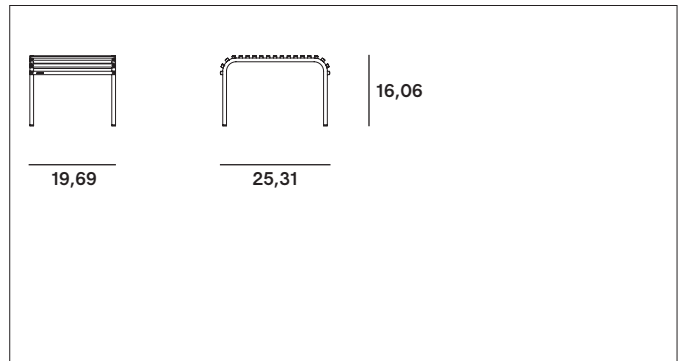

Sunbed

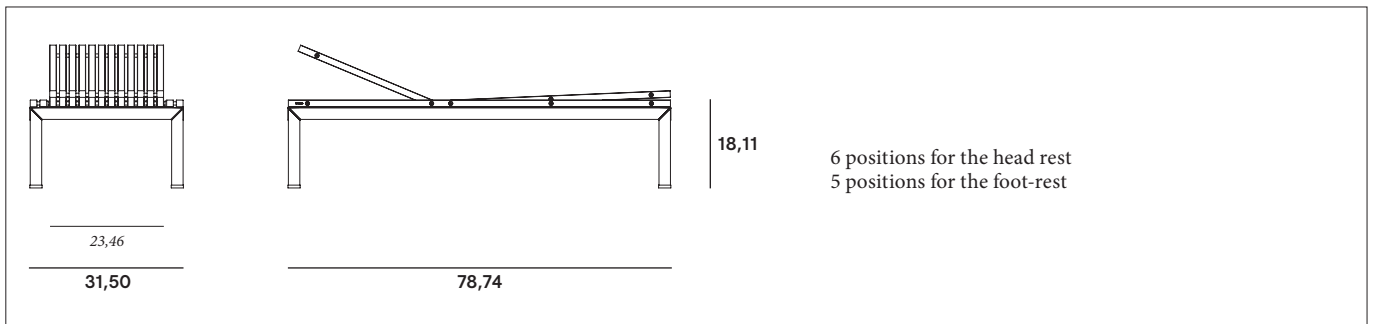

The content of this document, in particular the mentioned models, is protected by copyrights and/or design rights. The present document and its content is communicated to you for information purposes only. Any partial or total reproduction or any other use without our prior written permission is strictly prohibited. This technical sheet remains subject to possible changes. **All dimensions are in inch**, unless mentioned otherwise. Extremis is not responsible for the errors in the documentation of products. All measurements are approximate and are provided for informational purposes only.

Tech sheet
20200224



BOX 1: CHAIR

Maximum 4 chairs per box
 Gross weight (kg): 54,48 | Net weight (kg): 43,12

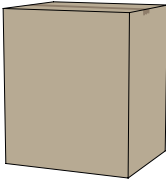

BOX 2: LOW CHAIR HIGH BACK

Maximum 2 low chairs high back per box
 Gross weight (kg): 37,37 kg | Net weight (kg): 24,60

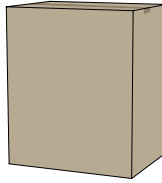

BOX 3: FOOTREST

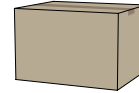

BOX 4: LOUNGE CHAIR

Maximum 2 lounge chairs per box:
 Gross weight (kg): 52,56 kg | Net weight (kg): 30,51

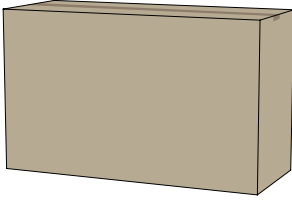

BOX 5: SUNBED



Box dimensions (inch)		L	W	H	Qty (#)	Volume (ft ³)	Gross weight (lb)	Net weight (lb)	Packaging weight (lb)
Chair	Box 1	31,22	26,77	37,01	1	18,01	22,13	10,78	11,35
Low chair high back	Box 2	31,50	23,23	37,80	1	15,89	24,56	11,79	12,76
Footrest	Box 3	25,59	20,28	16,93	1	4,94	14,73	9,22	5,51
Lounge chair	Box 4	64,76	26,18	39,37	1	38,49	36,80	14,75	22,05
Sunbed	Box 5	82,68	33,07	5,12	1	9,18	188,54	178,55	9,99

Standard table

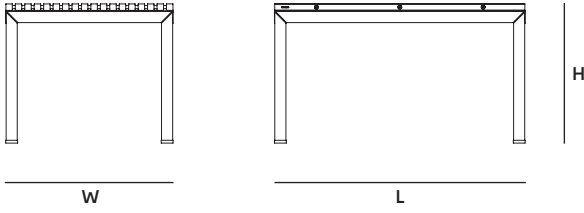

Dimensions (inch)	L	W	H
Standard table 135	53,15	35,43	29,53
Standard table 180	70,87	35,43	29,53
Standard table 225	88,58	35,43	29,53
Standard table 270	106,30	35,43	29,53

BOX 6: TABLETOP + LEGS + MOUNTING KIT



Box dimensions (inch)		L	W	H	Qty (#)	Volume (ft ³)	Gross weight (lb)	Net weight (lb)	Packaging weight (lb)
Standard table 135	Box 6	54,33	36,61	5,12	1	6,36	134,57	123,46	11,11
Standard table 180	Box 6	72,05	36,61	5,12	1	8,12	166,76	154,19	12,57
Standard table 225	Box 6	89,76	36,61	5,12	1	10,24	208,14	192,51	15,63
Standard table 270	Box 6	107,48	36,61	5,12	1	11,65	232,61	216,98	15,63

The tables below have the same length and width as the standard tables but have a different height:

- Medium table: **H** 27,17 inch **Weight** = Net weight of Standard table - 0,75 lb
- Low table: **H** 17,72 inch **Weight** = Net weight of Standard table - 3,75 lb
- Extra low table: **H** 9,06 inch **Weight** = Net weight of Standard table - 6,50 lb

Standard square table

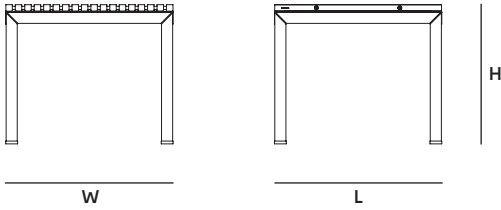

Dimensions (inch)	L	W	H
Standard square table 75	29,53	29,53	29,53
Standard square table 80	31,50	31,50	29,53
Standard square table 90	35,43	35,43	29,53

BOX 7: TABLETOP + LEGS + MOUNTING KIT

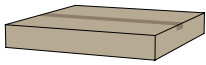

Box dimensions (inch)		L	W	H	Qty (#)	Volume (ft ³)	Gross weight (lb)	Net weight (lb)	Packaging weight (lb)
Standard square table 75	Box 7	30,71	30,71	5,31	1	2,83	109,42	100,31	9,11
Standard square table 80	Box 7	32,68	32,68	5,31	1	3,18	112,11	102,56	9,55
Standard square table 90	Box 7	36,61	36,61	5,31	1	4,24	114,77	104,79	9,99

The tables below have the same length and width as the standard square tables but have a different height:

- Medium table: **H** 27,17 inch **Weight** = Net weight of Standard table - 0,75 lb
- Low table: **H** 17,72 inch **Weight** = Net weight of Standard table - 3,75 lb
- Extra low table: **H** 9,06 inch **Weight** = Net weight of Standard table - 6,50 lb

Bench

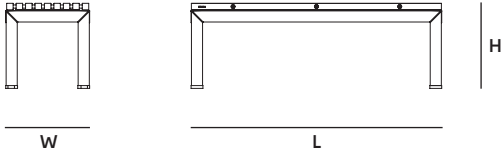

Dimensions (inch)	L	W	H
Bench 90	35,43	17,72	17,72
Bench 135	53,15	17,72	17,72
Bench 180	70,87	17,72	17,72
Bench 225	88,58	17,72	17,72
Bench 270	106,30	17,72	17,72

BOX 8: BENCHTOP + LEGS + MOUNTING KIT



Box dimensions (inch)		L	W	H	Qty (#)	Volume (ft ³)	Gross weight (lb)	Net weight (lb)	Packaging weight (lb)
Bench 90	Box 8	36,61	18,90	5,12	1	2,12	62,63	60,43	2,20
Bench 135	Box 8	54,33	18,90	5,12	1	3,18	82,76	79,34	3,42
Bench 180	Box 8	72,05	18,90	5,12	1	3,88	101,59	97,33	4,25
Bench 225	Box 8	89,76	18,90	5,12	1	4,94	128,11	122,05	6,06
Bench 270	Box 8	107,48	18,90	5,12	1	6,00	146,30	140,24	6,06

Bench with backrest

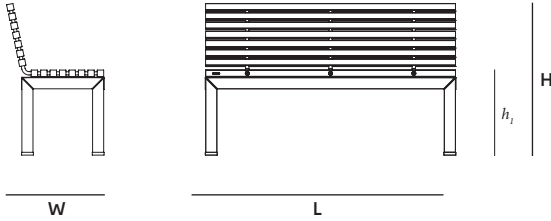

Dimensions (inch)	L	W	H	h_1
Bench with backrest 135	53,15	20,75	31,89	17,72
Bench with backrest 180	70,87	20,75	31,89	17,72
Bench with backrest 225	88,58	20,75	31,89	17,72
Bench with backrest 270	106,30	20,75	31,89	17,72

BOX 9: BENCHTOP WITH BACKREST + LEGS + MOUNTING KIT

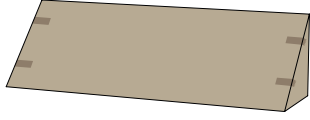

Box dimensions (inch)		L	W	H	Qty (#)	Volume (ft ³)	Gross weight (lb)	Net weight (lb)	Packaging weight (lb)
Bench with backrest 135	Box 9	61,02	21,65	19,49	1	14,83	111,82	108,07	3,75
Bench with backrest 180	Box 9	78,74	21,65	19,49	1	19,07	142,04	135,30	6,75
Bench with backrest 225	Box 9	96,46	21,65	19,49	1	23,66	179,70	169,89	9,81
Bench with backrest 270	Box 9	114,17	21,65	19,49	1	27,90	209,17	199,58	9,81

Bench with back- & armrest

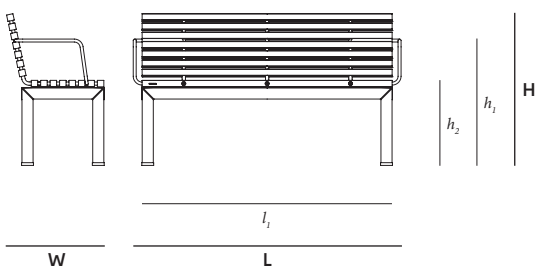

Dimensions (inch)	L	W	H	l_1	h_1	h_2
Bench with back- & armrest 135	61,02	20,75	31,89	57,09	26,77	17,72
Bench with back- & armrest 180	78,74	20,75	31,89	74,80	26,77	17,72
Bench with back- & armrest 225	96,46	20,75	31,89	92,52	26,77	17,72
Bench with back- & armrest 270	114,17	20,75	31,89	110,24	26,77	17,72

BOX 10: BENCHTOP WITH BACK- & ARMREST + LEGS + MOUNTING KIT

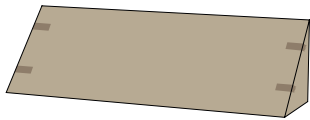

Box dimensions (inch)		L	W	H	Qty (#)	Volume (ft ³)	Gross weight (lb)	Net weight (lb)	Packaging weight (lb)
Bench with back- & armrest 135	Box 10	54,33	18,90	19,69	1	11,65	116,38	112,63	3,75
Bench with back- & armrest 180	Box 10	72,05	18,90	19,69	1	15,54	133,12	139,86	6,75
Bench with back- & armrest 225	Box 10	89,76	18,90	19,69	1	19,42	186,58	176,77	9,81
Bench with back- & armrest 270	Box 10	107,48	18,90	19,69	1	23,31	211,45	201,63	9,81

Table extra high

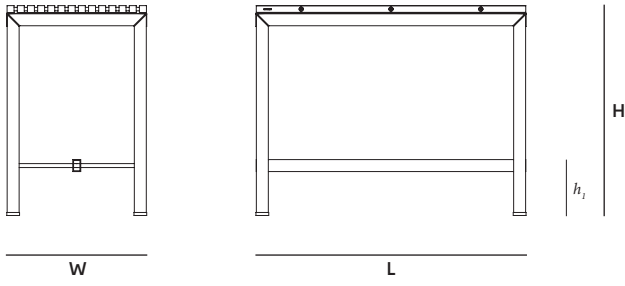

Dimensions (inch)	L	W	H	h_1
Table extra high 135	53,15	27,56	41,34	10,63
Table extra high 270	106,30	27,56	41,34	10,63

BOX 11: TABLETOP + MOUNTING KIT



BOX 12: FOOTREST



Box dimensions (inch)		L	W	H	Qty (#)	Volume (ft ³)	Gross weight (lb)	Net weight (lb)	Packaging weight (lb)
Table extra high 135	Box 11	54,33	29,13	5,31	1	4,94	128,26	122,80	5,47
	Box 12	54,33	2,76	1,97	1	0,35	19,14	13,67	5,47
					total:	5,30	151,81	140,88	10,93
Table extra high 270	Box 11	107,48	29,13	5,31	1	9,53	211,84	201,86	9,99
	Box 12	107,48	2,76	1,97	1	0,35	28,75	19,71	9,04
					total:	9,89	240,59	221,56	19,03

Bench extra high

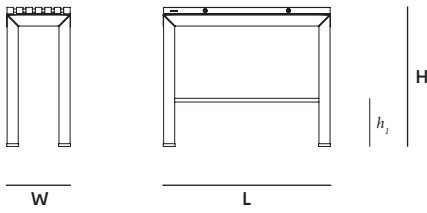

Dimensions (inch)	L	W	H	h_1
Bench extra high	35,43	13,39	29,53	10,63

BOX 13: BENCHTOP + MOUNTING KIT



BOX 14: FOOTREST



Box dimensions (inch)		L	W	H	Qty (#)	Volume (ft ³)	Gross weight (lb)	Net weight (lb)	Packaging weight (lb)
Bench extra high	Box 13	36,61	14,57	5,31	1	1,77	70,50	60,52	9,99
	Box 14	36,61	2,76	1,97	1	0,35	6,24	1,72	4,52
					total:	2,12	76,74	62,24	14,51

Materials & colors

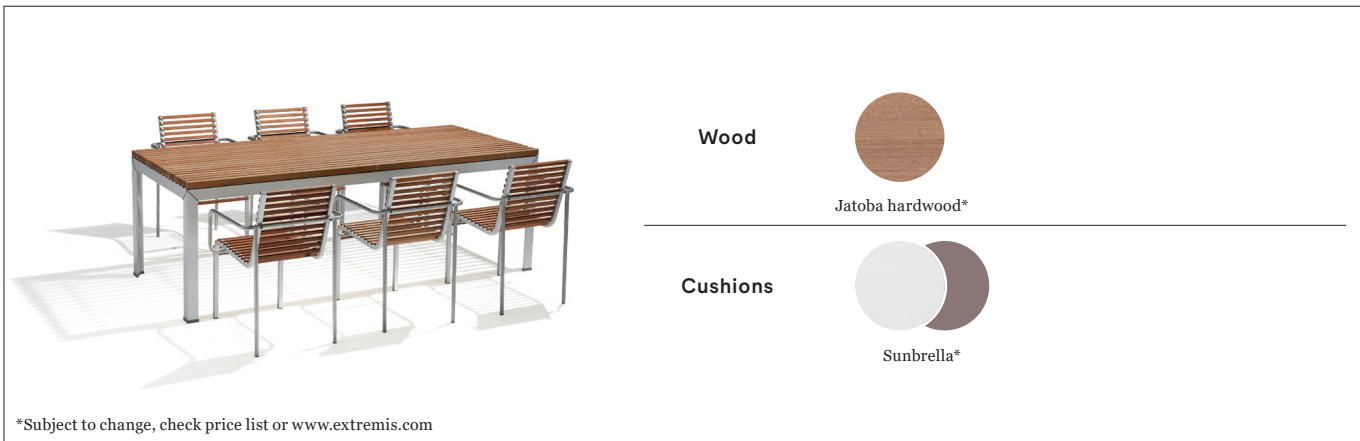

*Subject to change, check price list or www.extremis.com

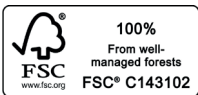
Materials	Key facts	Thickness inch	Layer thickness micron	Density	In/outdoor	Water	UV colour fastness	Flame retarding
Jatoba hardwood	<ul style="list-style-type: none"> • Durability CLASS 1 • Exceptional quality • Characteristics: durability & stability • Bleeds when wood is exposed to rain for the first few times • The dye is water-soluble • Feels comfortable in all weather conditions 	0,70 - 1,37	n.a.	53 lb/ft ³	Outdoor & indoor	n.a.	Untreated wood turns grey after a while	/
								
Anodised aluminium frame & legs (chairs, benches & tables)	<ul style="list-style-type: none"> • A process aimed at thickening the existing aluminium oxide layer • Thickest layer of protection 	0,11 - 0,39	50 - 100	0,16 10 ³ lb/ft ³	Outdoor & indoor	n.a.	Very good	NEN-EN 13501-1 A1*
Stainless steel legs AISI 316 (chairs)	<ul style="list-style-type: none"> • Highest stainless steel quality available (AISI 316) • High rust resistance • Periodical maintenance required 	0,07 - 0,31	n.a.	0,50 10 ³ lb/ft ³	Outdoor & indoor	n.a.	Very good	NEN-EN 13501-1 A1*
Sunbrella cushions	<ul style="list-style-type: none"> • 100% Sunbrella Acrylic • Best outdoor fabric available for making cushions • Dirt repellent • Not waterproof, store inside! • Machine washable at max. 30°C. Ironing restores the protective layer 	0,31	n.a.	0,04 oz/ft ²	Outdoor & indoor	The fabric has a water column of 35mbar (EN 20811)	7/8 (ISO 105-B02)	/

* NEN-EN13501-1 A1

Class A1 products will not contribute to fire in any stage, including fully developed fire. For this reason, they are assumed to be capable of satisfying all requirements of all lower classes as well

Warnings

General

- Do not use any sharp tools to open the packaging.
- We strongly advise against using power tools.
- Tripping hazard, mind your step.
- Do not put out cigarettes on the table chairs & benches.
- Not graffiti proof.
- Do not leave children unattended whilst playing on the table.
- To avoid danger of suffocation, keep plastic bags away from babies and children.
- Colours can differ over years and from batch to batch.

Product

- Do not drag the table, but carry it with minimum 2 people.
- Anchoring the product has to be done by qualified people.
- For anchoring: use suitable bolts or screws from a specialized store depending on the material your terrace is made of.

Wood

- When delivered, the wood is untreated.

- The wood can bleed when it's exposed to rain for the first few times.
- Wood is a natural material and its look is different for every slat, plank and tree.
- Wood will gradually become rougher and start to turn grey as a consequence of exposure to the sun and rain. We recommend oiling the wood at regular intervals depending from location and general weather conditions.
- Clean regularly with mild detergent. Never use a high pressure cleaner as this will roughen the wood's smooth surface and irreparably damage the wood's fiber.
- Thorough cleaning with Extremis Wood Cleaner.
- We strongly recommend that you treat your wood with wood protector to protect it from stains - Small cracks and crevices can also appear as part of this process. We strongly advise everyone to treat the furniture with our Wood Protector.

Stainless steel

- Very good UV colour fastness.
- Flame retarding: NEN-EN13501-1 A1 - Class A1 products will not contribute to fire in any stage,

including fully developed fire. For this reason, they are assumed to be capable of satisfying all requirements of all lower classes as well.

- Watch out, stainless steel isn't entirely rustproof! Be sure to avoid contact with iron objects. If it does show signs of rust, clean with rust remover as quickly as possible.

Sunbrella

- Not waterproof, store inside!
- Shake or brush off loose dirt immediately.
- UV colour fastness: 7/8 (ISO 105-B02).

Anodised aluminium

- Do not use abrasive scouring powders or scourers as they will scratch the surface.
- Colour can fade to some extent when exposed to UV.
- Flame retarding - NEN-EN13501-1 A2-sl - Satisfying the same criteria as Class B for the SBI-test according to EN13823. In addition, under conditions of a fully developed fire these products will not significantly contribute to the fire load and fire growth.
- Dark colors can get very hot in sunny weather.

Applications

Residential: Extempore is a complete range for the garden. **Project:** hotel and catering industry, company terraces, public spaces, ...

F.a.q.

Q: Do you need to oil the wood?

A: Just like other types of wood, Iroko will gradually become rougher and start to turn grey as a consequence of exposure to the sun and rain. Small cracks and crevices can also appear as part of this process. We strongly advise everyone to treat the furniture with our Wood Protector. This 100% natural oil controls the moisture level within the wood, which makes the planks stay stable for longer, and the layer of oil also helps to prevent spilled liquids from being absorbed, so that stains tend to stay superficial. It is best to repeat this treatment at regular intervals.

Maintenance

Find maintenance instructions at the downloads section of extremis.com for:

WOOD

- Clean regularly with mild detergent.
- Thorough cleaning with Extremis Wood Cleaner.
- Oil the wood with Extremis Wood Protector. We recommend oiling the wood at regular intervals depending from location and general weather conditions.
- In order to smoothen the surface again after a thorough cleaning, lightly sand your wood with 80 grit sanding paper or a sanding pad.

STAINLESS STEEL

- Clean regularly with a dry cloth and some stainless steel cleaner.

ANODISED PARTS

- Clean with lukewarm water and a mild detergent or with Extremis Multi Cleaner.

Floor fastening

Extempore comes with an optional floor anchoring set.

Good to know

- There are cushions available for all chairs and benches.
- There are optional wheels available for all tables and sunbed.



Website

www.extremis.com/extempore