

SUSHI

Sushi

Family

Armchair / Sofa / Ottoman
Bench / System

Designer

Mauro Fadel / 2002



SUSHI

Dati tecnici · Technical data · Données techniques · Technische Angaben

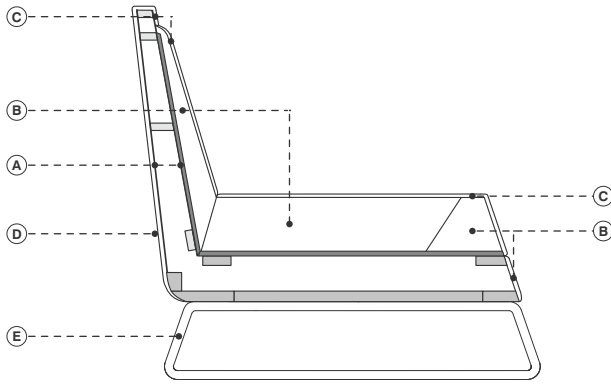

■ Legno massiccio di abete	■ Solid fir	■ Bois de sapin massif	■ Massivholz aus Tanne
■ Legno massiccio di faggio	■ Solid beech	■ Bois de hêtre massif	■ Massivholz aus Buche
■ Multistrato di faggio	■ Multilayered beech	■ Multiplis de hêtre	■ Buchenschichtholz
A. Pannello di masonite	A. Masonite panels	A. Panneau de particules	A. Holzfaserplatte
B. Poliuretano espanso ignifugo indeformabile a quote differenziate	B. Flame-retardant undeformable polyurethane foam of different densities	B. Mousse polyuréthane expansé ignifuge indéformable à épaisseurs différenciées	B. Feuerfester formbeständige Polyurethanschaum in unterschiedlicher Dichte
C. Fibra di poliestere	C. Polyester fibers	C. Fibre de polyester	C. Polyester
D. Rivestimento fisso in tessuto o pelle	D. Fixed upholstery in fabric or leather	D. Revêtement pas déhoussable en tissu ou cuir	D. Unabziehbarer Bezug aus Stoff oder Leder
E. Acciaio	E. Steel	E. Acier	E. Stahl

Note · Notes · Annotation · Anmerkung

<ul style="list-style-type: none"> • Base personalizzabile con tinta cliente • Prodotto disponibile su misura con preventivo su richiesta • Su richiesta attacco per connessione elettrica e USB con sovrapprezzo • Cuscini extra disponibili • COM: tessuto cliente (tinta unita e h. 140 cm.) - campione richiesto • COL: pelle cliente - campione richiesto • CAT. SPECIAL: prezzo e disponibilità su richiesta 	<ul style="list-style-type: none"> • Base customizable with customer's colors on request • This item can be tailor made with price on request • Electrical connection and USB upon request with upcharge • Extra cushions available • COM: client's fabric (plain colour and width 140 cm.) - sample required • COL: client's leather - sample required • CAT. SPECIAL: price and availability on request 	<ul style="list-style-type: none"> • Piètement disponible en autres finitions sur demande • Collection personnalisable sur demande • Sur demande connection électrique et USB avec surcoût • Autres coussins disponibles • COM: tissu fourni (couleur unie et hauteur 140 cm.) - échantillon nécessaire • COL: cuir fourni - échantillon nécessaire • CAT. SPECIAL: prix et disponibilité sur demande 	<ul style="list-style-type: none"> • Gestell in Kundenfarben auf Anfrage verfügbar • Produkt nach Maß verfügbar auf Anfrage • Elektrische Verbindung und USB-Anschluss auf Anfrage gegen Aufpreis • Weitere Kissen verfügbar • COM: Kundenstoff (einfarbig und Breite 140 cm.) - Stoffmuster nötig • COL: Kundenleder - Ledermuster nötig • CAT. SPECIAL: Preis und Verfügbarkeit auf Anfrage
---	--	--	--

Sistema di aggancio · System connector · Systeme d'assemblage · Verbindungshaken Opzione · Option · Option · Opzjon



Sistema di aggancio tra elementi
Components connector
Systeme d'assemblage de socle
Verbindungssystem zwischen Elementen



Su richiesta attacco per connessione elettrica e USB con sovrapprezzo
Electrical connection and USB upon request with upcharge
Sur demande connection électrique et USB avec surcoût
Elektrische Verbindung und USB-Anschluss auf Anfrage gegen Aufpreis

Finiture base · Base finishes · Finitions piètement · Gestell Ausführungen



Cromato lucido
Polished chrome steel
Acier chromé brillant
Stahl Chrom poliert



Nero (RAL 9005)
Black (RAL 9005)
Noir (RAL 9005)
Schwarz (RAL 9005)

Rivestimenti consigliati · Recommended coverings · Revêtements conseillées · Empfohlene Bezüge

• cat. A XTREME	• cat. C TREND	• cat. extra MOLLY	• cat. lux LUX 1
• cat. A STEP	• cat. C SUPERB	• cat. extra RIME	• cat. lux LUX 2
• cat. A ANGEL	• cat. C UMAMI	• cat. extra STEELCUT TRIO 3	• cat. imperial IMPERIAL 1
• cat. A MEDLEY	• cat. C HESTAN	• cat. extra COLLINE	• cat. imperial IMPERIAL 2
• cat. A MOOD	• cat. C DEANS	• cat. extra OPERA	• cat. imperial NABUK
• cat. A CRAZY	• cat. super REMIX 2	• cat. extra DANTE	• cat. special DROP
• cat. B EXTREMA	• cat. super CAPTURE	• cat. extra ARCO	
• cat. B IKON	• cat. super MODA	• cat. extra HALLINGDAL 65	
• cat. B SILVERTEX	• cat. super REVIVE 1	• cat. maxi COMFORT	
• cat. B SAMAR	• cat. super BREEZE FUSION	• cat. maxi DIVINA 3	
• cat. B FAME			
• cat. B MAIN LINE FLAX			

SUSHI

cod. 4001 / **element 60**

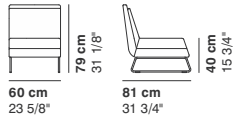

cod. 4002 / **element 90**

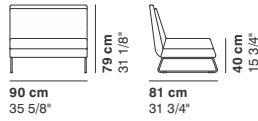

cod. 4003 / **element 120**

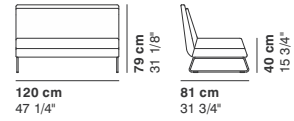

cod. 4004 / **element 150**

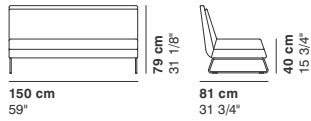

cod. 4005 / **element 200**

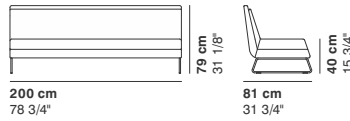

cod. 4006 / **element 250**

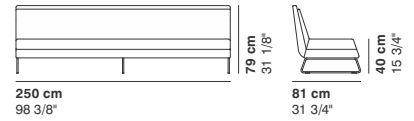

cod. 4007 / **ottoman 60**

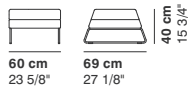

cod. 4008 / **ottoman 90**

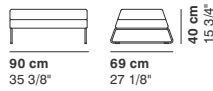

cod. 4009 / **ottoman 120**



cod. 4010 / **bench 150**

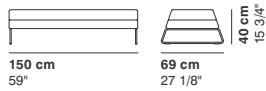

cod. 4011 / **bench 200**



cod. 4012 / **open element 100**

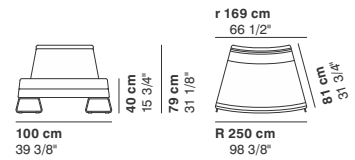

cod. 4013 / **closed element 100**

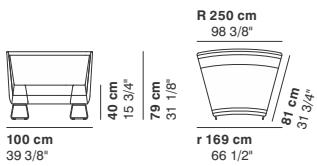

cod. 4014 / **open element 200**

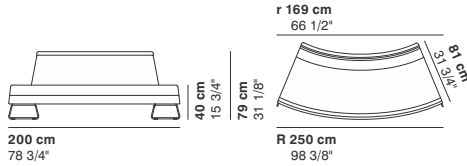

cod. 4015 / **closed element 200**

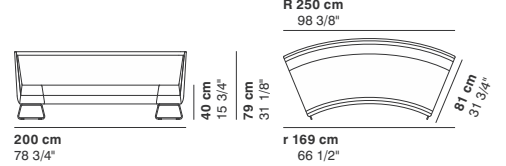

cod. 4016 / **closed element 90°**

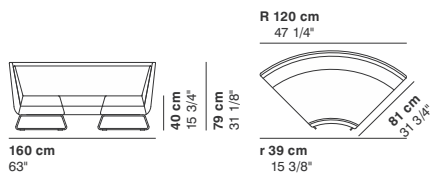

cod. 4017 / **open element 90°**

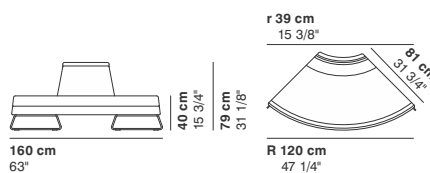

cod. 4018 / **closed ottoman 90°**

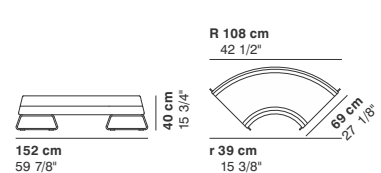

SUSHI

cod. 4019 / closed ottoman 188

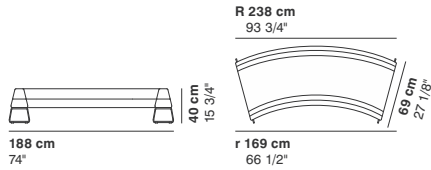

cod. 4020 / open ottoman 90°

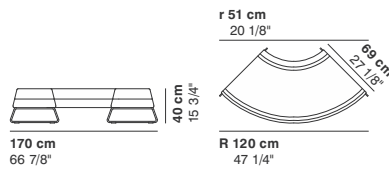

cod. 4021 / open ottoman 176

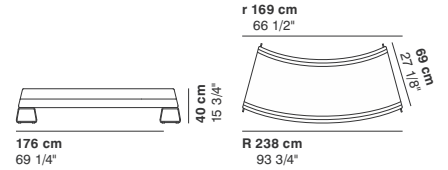

cod. SUS01 / composition

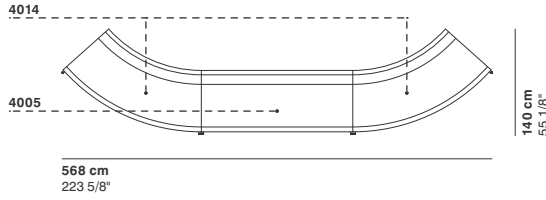

cod. SUS02 / composition

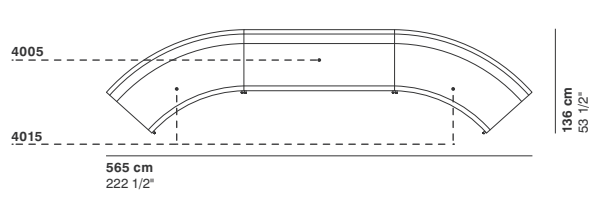

cod. SUS03 / composition

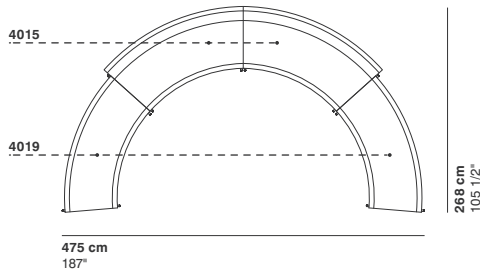

cod. SUS04 / composition

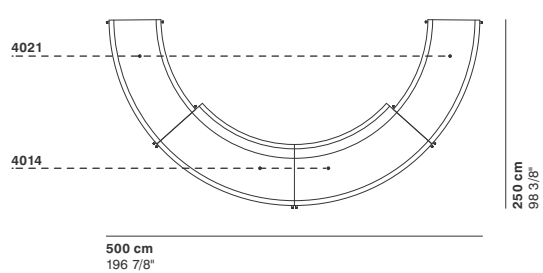

cod. SUS05 / composition

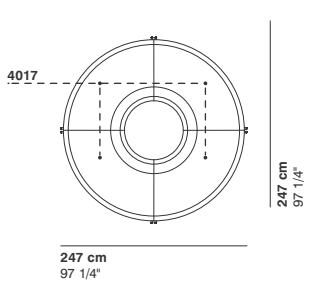

cod. SUS06 / composition

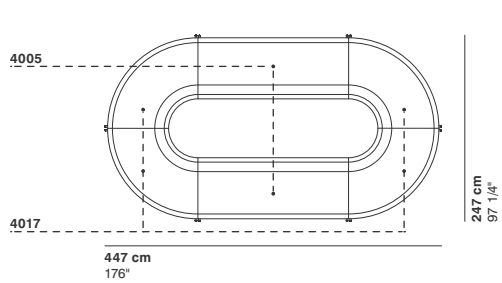

cod. SUS07 / composition

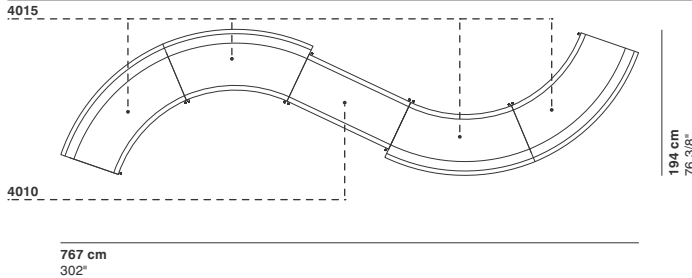

cod. SUS08 / composition

