

# STARLIGHT HORIZONTAL

DESIGN MASSIMO CASTAGNA

## FINISHES

### Y-Shaped Central Body



Sandcasting Brass Sandcasting Bronze Sandcasting Silver

### Lighting Body

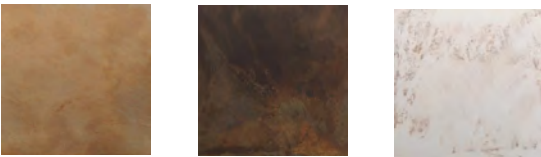

Burnished Brass Black Burnished Brass H-Silver

Certified product:



### STRUCTURE

Dimmable pendant energy saving led lamp (Energy efficiency index A) with Y-shaped central body sandcasting brass, sandcasting bronze or sandcasting Silver. Lighting body in burnished brass, black burnished brass, H-Silver. Low voltage power supply cable through suspension cable. Transformer incorporated in the ceiling rosette. Available alternative fixing system for lamp with remote transformer. Available extra warm light 2700K (without extra costs). Only for indoor use. Dimmable push button. Other dimming systems available upon request. Standard overall height 70.9 in.

## TECHNICAL DATA

### STARLIGHT HORIZONTAL

In 52.75x42.5x70.75h with downward pointing led, 3000K

In 57.5x28.25x80h with downward pointing led, 3000K

In 58.75x37x80h with downward pointing led, 3000K

### STARLIGHT HORIZONTAL MAXI

In 89x53.5x70.75h with downward pointing led, 3000K

In 83x65.5x70.75h with downward pointing led, 3000K

In 80x39.5x80h with downward pointing led, 3000K

### STARLIGHT HORIZONTAL XL

In 103.25x68.5x70.75h with downward pointing led, 3000K

In 122.5x49.5x70.75h with downward pointing led, 3000K

In 120hx61.5x70.75h with downward pointing led, 3000K

### STARLIGHT HORIZONTAL XL MAXI

In 180.75x89x70.75h with downward pointing led, 3000K

In 190.25x110.25x70.75h with downward pointing led, 3000K

In 159.5x98x70.75h with downward pointing led, 3000K

## TECHNICAL DRAWINGS

Starlight Horizontal

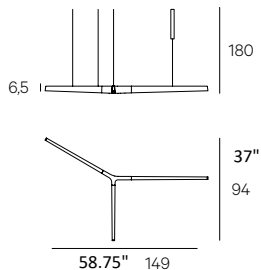
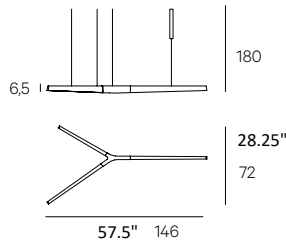
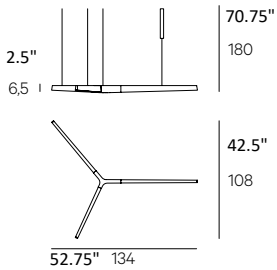

## TECHNICAL DRAWINGS

Starlight Horizontal Maxi

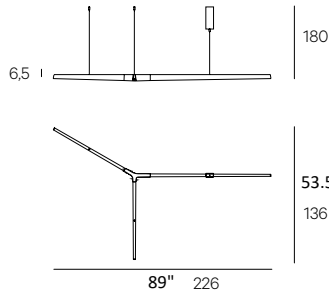
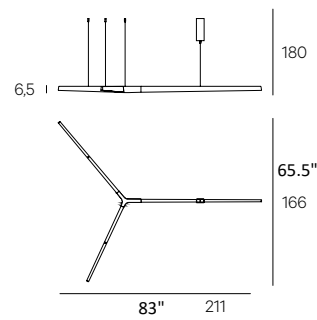
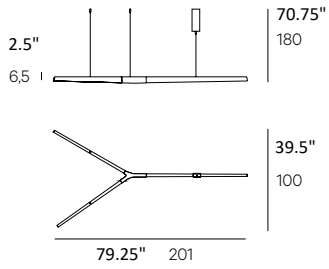

Starlight Horizontal XL

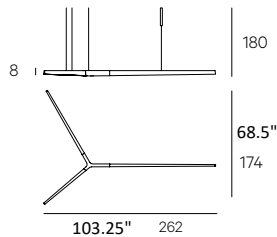
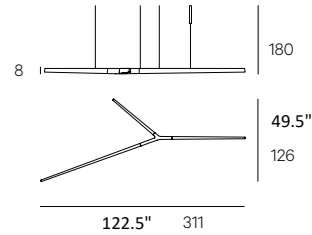
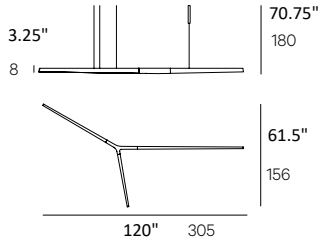

## TECHNICAL DRAWINGS

Starlight Horizontal XL Maxi

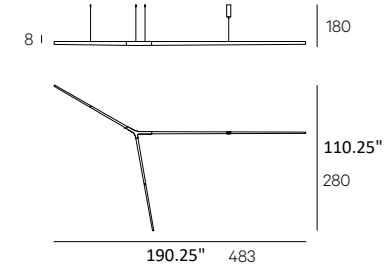
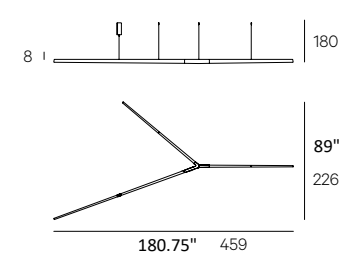
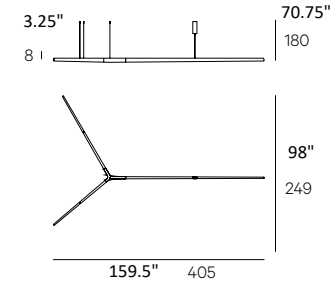

## CARE AND MAINTENANCE OF METALS

Always clean stains while they are still fresh. For routine maintenance use a microfiber cloth and water. Do not use products containing acids, limescale removing substances or alcohol.