

TIMEOUT COLLECTION

REGENT —

VINCENT VAN DUYSSEN 2022

1—
3



The rounded shape of the tops, which have no edges, and the theme of the metal band, here in a vertical rather than horizontal position, cite both the compositional fil rouge of the Timeout Collection and the organicity of the lines underlying the Landmark Collection. Similarly, the chromatic and material recurrence of the burnished metal and the top in Etna lava stone, give the Regent coffee tables a sense of continuity between the two collections.



The product may be used outdoors but requires particular care in the event of rain (see price list maintenance and waterproof cover)



Product suitable for collective uses (Contract)



The product is sent in multiple packaged and/or flat packed

REGENT —
VINCENT
VAN DUYSSEN
2022

FINISHES

STRUCTURE FINISHES

burnished metal

TOP FINISHES

lava stone anthracite

lava stone olive green

lava stone desert yellow

TECHNICAL INFORMATION

STRUCTURE

painting aluminium, plastic ferrules

TOP

enamelled lava stone

WATERPROOF COVER

100% polyester

2—
3

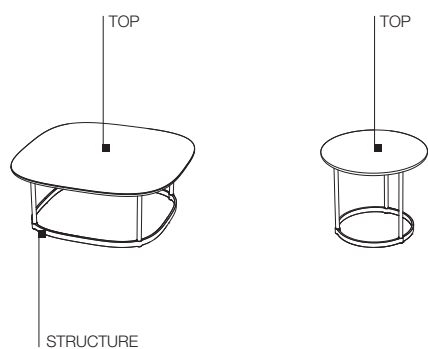

DIMENSIONS

Notes

► No reductions of any kind or changes to the finish are possible.

When ordering

Always specify the top finish.

rectangular coffee table

RTV08

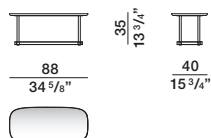

waterproof cover XRTV08

rectangular coffee table

RTV16

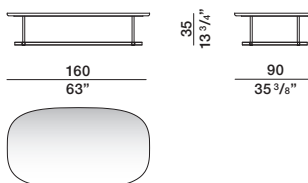

waterproof cover XRTV16

square coffee table

RTQ09

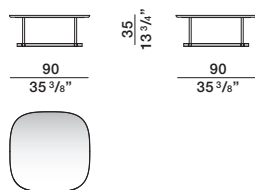

waterproof cover XRTQ09

square coffee table

RTQ12

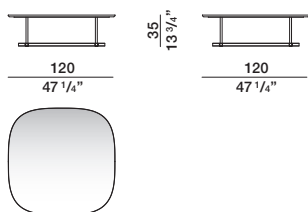

waterproof cover XRTQ12

round coffee table

RTR01

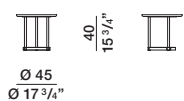

waterproof cover XRTR01

round coffee table

RTR02

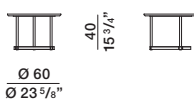

waterproof cover XRTR02

round coffee table

RTR11

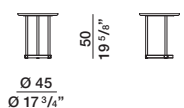

waterproof cover XRTR11

round coffee table

RTR12

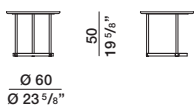

waterproof cover XRTR12