

classic	sizes [ft/m]	applies to				a (in/cm)	b (in/cm)	c (in/cm)	d (in/cm)	e (in/cm)	f (in/cm)	g (in/cm)	ft ²
		ocean master	plantation	bay master	vineyard								
square	5.5' / 1.65m	✓	✓	✓	✓	93 / 237	78 / 198	93 / 237	47 / 119	10 / 26	65 / 166	91 / 232	28.75
	6.5' / 2.0m	✓	✓	✓	✓	93 / 237	76 / 193	93 / 237	34 / 86	15 / 38	80 / 204	113 / 288	44.5
	7.5' / 2.25m	✓	✓	✓	✓	97 / 247	79 / 200	97 / 247	35 / 89	13 / 33	88 / 224	125 / 318	54.25
	8.0' / 2.4m (4 ribs)	n/a	n/a	✓	✓	97 / 247	74 / 188	97 / 247	28 / 71	11 / 28	96 / 244	135 / 343	72
	8.5' / 2.6m (8 ribs)	✓	✓	n/a	n/a	97 / 247	74 / 188	97 / 247	23 / 58	13 / 33	102 / 260	143 / 363	72
octagon	6.0' / 1.8m	✓	✓	n/a	n/a	91 / 232	78 / 198	91 / 232	52 / 132	11 / 28	68 / 173	73 / 186	26
	7.5' / 2.25m	✓	✓	✓	✓	93 / 237	78 / 198	93 / 237	46 / 117	15 / 38	85 / 216	92 / 234	40.75
	9.0' / 2.75m	✓	✓	✓	✓	93 / 237	74 / 188	93 / 237	35 / 89	13 / 33	105 / 267	114 / 290	62.75
	10.5' / 3.2m	✓	✓	✓	✓	97 / 247	80 / 203	97 / 247	32 / 81	14 / 36	116 / 295	125 / 318	76.75
	11.5' / 3.6m	✓	✓	n/a	n/a	97 / 247	75 / 190	97 / 247	27 / 68	11 / 28	125 / 318	135 / 343	89.5
hexagon	7.0' / 2.15m	✓	✓	✓	✓	93 / 237	78 / 198	93 / 237	46 / 117	13 / 33	80 / 204	93 / 236	37.5
	8.5' / 2.6m	✓	✓	✓	✓	93 / 237	75 / 190.5	93 / 237	35 / 88	13 / 33	99 / 251.5	114 / 290	57.5
	10.0' / 3.0m	✓	✓	✓	✓	97 / 247	80 / 203	97 / 247	32 / 81	14 / 36	108 / 275	125 / 318	70.5
	11.0' / 3.4m	✓	✓	n/a	n/a	97 / 247	75 / 190	97 / 247	27 / 68	14 / 36	117 / 298	135 / 343	82.25
rectangle	5.0' x 8.0' / 1.5m x 2.45m	✓	✓	n/a	n/a	97 / 247	80 / 203	97 / 247	38 / 96	12 / 31	f ¹ X f ² 57x98 / 145x249	113 / 288	38.75
	6.0' x 9.0' / 1.8m x 2.75m	✓	✓	✓	✓	97 / 247	72 / 183	97 / 247	29 / 74	12 / 31	f ¹ X f ² 75x112 / 191x285	134 / 340	58.25

Dimension Tolerances ± 2"
 Dimensions shown correspond to indicated lift system
 Options are subject to change without notice
 Some options are only available in certain sizes and shapes

Pole Diameter 1.5"
 base height not included

ocean master, plantation, bay master & vineyard classic

“auto-loc-lift” marine pulley lift

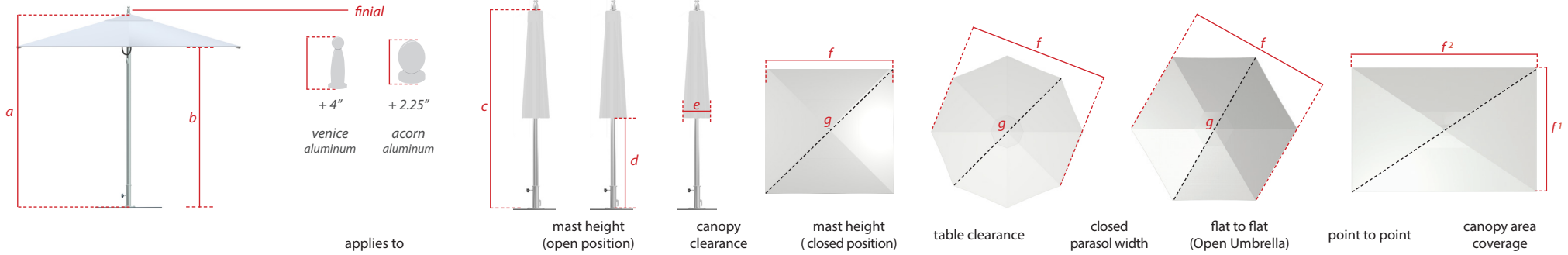

classic	sizes [ft/m]	premium		essential		a (in/cm)	b (in/cm)	c (in/cm)	d (in/cm)	e (in/cm)	f (in/cm)	g (in/cm)	ft ²
		ocean master	plantation	bay master	vineyard								
square	5.5' / 1.65m	✓	✓	✓	✓	93 / 237	78 / 198	93 / 237	45 / 114	11 / 28	64 / 163	91 / 232	28.75
	6.5' / 2.0m	✓	✓	✓	✓	93 / 237	75 / 190.5	93 / 237	32 / 81	10 / 25	79 / 201	113 / 288	44.5
	7.5' / 2.25m	✓	✓	✓	✓	97 / 247	78 / 198	97 / 247	33 / 84	12 / 30	88 / 224	125 / 318	54.25
	8.0' / 2.4m (4 ribs)	n/a	n/a	✓	✓	93 / 237	70 / 190.5	93 / 237	24 / 60	13 / 33	95 / 241	135 / 343	72
	8.5' / 2.6m (8 ribs)	✓	✓	n/a	n/a	96.5 / 245	73 / 185	96.5 / 245	23 / 58	9 / 23	102 / 260	144 / 366	72
	10.0' / 3.0m auto-scope	✓	✓	n/a	n/a	103 / 262	84 / 213	118 / 300	32 / 81	15 / 38	119 / 303	170 / 432	94.25
octagon	6.0' / 1.8m	✓	✓	n/a	n/a	91 / 232	77 / 195	91 / 232	52 / 132	11 / 28	68 / 173	73 / 186	26
	7.5' / 2.25m	✓	✓	✓	✓	93 / 237	78 / 198	93 / 237	45 / 114	16 / 41	85 / 216	92 / 234	40.75
	9.0' / 2.75m	✓	✓	✓	✓	93 / 237	74 / 188	93 / 237	36 / 91	10 / 25	105 / 267	113 / 288	62.75
	10.5' / 3.2m	✓	✓	✓	✓	97 / 247	78 / 198	97 / 247	32 / 81	12 / 31	115 / 293	125 / 318	76.75
	11.5' / 3.6m	✓	✓	n/a	n/a	97 / 247	75 / 190	97 / 247	27 / 68	11 / 28	125 / 318	135 / 343	89.5
	13.0' / 4.0m auto-scope	✓	✓	n/a	n/a	100 / 254	83 / 210	113 / 288	30 / 76	12 / 31	142 / 361	154 / 392	116.5
hexagon	7.0' / 2.15m	✓	✓	✓	✓	93 / 237	80 / 203	93 / 237	45 / 114	11 / 28	79 / 201	92 / 234	37.5
	8.5' / 2.6m	✓	✓	✓	✓	93 / 237	76 / 193	93 / 237	35 / 89	12 / 31	100 / 254	113 / 288	57.5
	10.0' / 3.0m	✓	✓	✓	✓	97 / 247	77 / 196	97 / 247	32 / 81	12 / 31	108 / 275	125 / 318	70.5
	11.0' / 3.4m	✓	✓	n/a	n/a	97 / 247	73 / 185	97 / 247	28 / 71	14 / 36	116 / 295	135 / 343	82.25
rectangle	5.0' x 8.0' / 1.5m x 2.45m	✓	✓	n/a	n/a	97 / 247	80 / 203	97 / 247	39 / 99	11 / 28	f ¹ X f ² 57x98 145x249	113 / 288	38.75
	6.0' x 9.0' / 1.8m x 2.75m	✓	✓	✓	✓	97 / 247	74 / 188	97 / 247	28 / 71	7 / 18	f ¹ X f ² 75x112 191x285	134 / 340	58.25
	8.0' x 12.0' / 2.45m x 3.65m auto-scope	✓	✓	n/a	n/a	103 / 262	86 / 218	115 / 293	31 / 79	13 / 33	f ¹ X f ² 95x142 242x361	171 / 435	93.75





Dimension Tolerances ± 2"

Pole Diameter 1.5"
base height not included

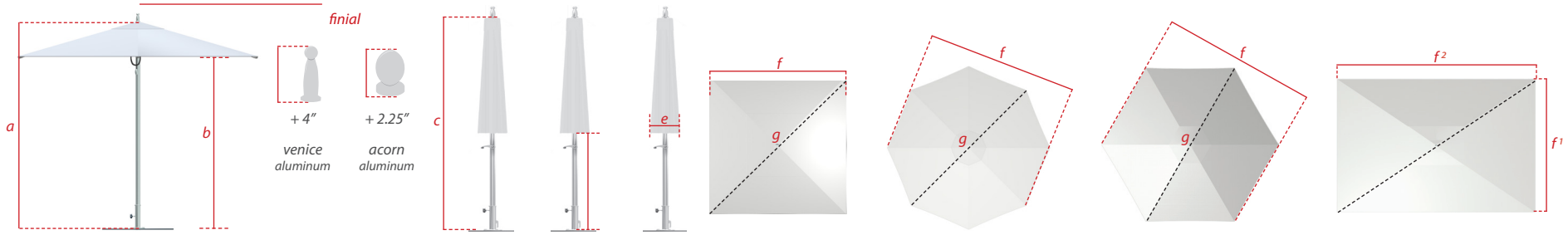
ocean master and plantation classic

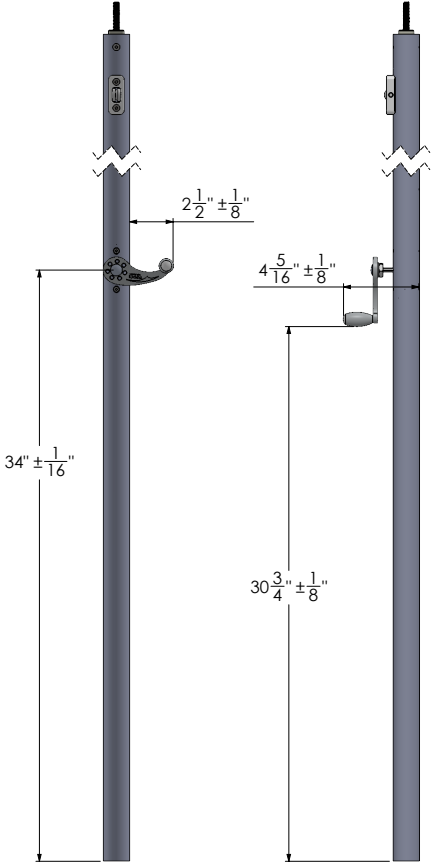
"easy drive" crank lift system



	classic	sizes [ft/m]	mast height (open position) a (in/cm)	canopy clearance b (in/cm)	mast height (closed position) c (in/cm)	table clearance d (in/cm)	closed parasol width e (in/cm)	flat to flat (Open Umbrella) f (in/cm)	point to point g (in/cm)	canopy area coverage ft ²	crank handle clearance
 square		6.5' / 2.0m	95 / 242	75 / 190	95 / 242	38 / 96	12 / 31	80 / 204	113 / 288	44.5	
		7.5' / 2.25m	95 / 242	73 / 185	95 / 242	32 / 81	13 / 33	88 / 244	124 / 315	54.25	
		8.5' / 2.6m	106 / 210	82 / 208	106 / 270	32 / 81	13 / 33	101 / 257	143 / 363	72	
		10.0' / 3.0m <i>telescoping mast</i>	104.5 / 265	83 / 210	139 / 354	52 / 132	15 / 81	119.5 / 304	169 / 430	99.25	
 octagon		9.0' / 2.75m	94 / 188	80 / 203	94 / 188	37 / 94	15 / 81	105.5 / 268	114 / 290	62.75	
		10.5' / 3.2m	94 / 188	77 / 196	94 / 188	32 / 81	16 / 41	115 / 293	125 / 317.5	76.75	
		11.5' / 3.6m <i>telescoping mast</i>	97 / 247	75 / 190	121 / 308	51 / 130	16 / 41	125 / 318	135 / 343	89.5	
		13.0' / 4.0m <i>telescoping mast</i>	102 / 259	77 / 196	130.5 / 331	53 / 135	17 / 43	143 / 363	155 / 394	115	
 hexagon		8.5' / 2.6m	95 / 242	78 / 198	95 / 242	36 / 91	11 / 28	98 / 249	113 / 288	57.5	
		10.0' / 3.0m	95 / 242	77 / 196	95 / 242	33 / 84	16 / 41	109 / 277	125 / 317.5	70.5	
		11.0' / 3.4m	99 / 252	77 / 195	99 / 252	30 / 76	12 / 31	117 / 298	135 / 343	82.25	
 rectangle		6.0' x 9.0' / 1.8m x 2.75m	98 / 249	76 / 143	98 / 249	29 / 73	13 / 33	f ¹ X f ² 75x112 191x285	135 / 343	58.25	
		8.0' x 12.0' / 2.45m x 3.65m <i>telescoping mast</i>	100 / 254	87 / 221	134 / 340	48.5 /	52 / 132	f ¹ X f ² 94x141 239x359	172 / 437	92	

Dimension Tolerances ± 2"
Dimensions shown correspond to indicated lift system

Pole Diameter 1.5"
base height not included

ocean master, plantation, bay master & vineyard classic (cont.)

vent and pocket options

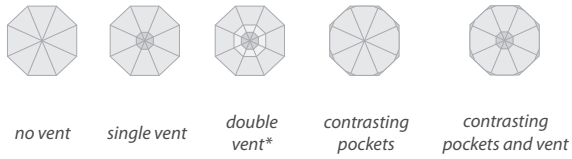

profile options

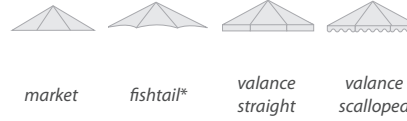

canopy options

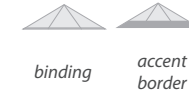

panel options

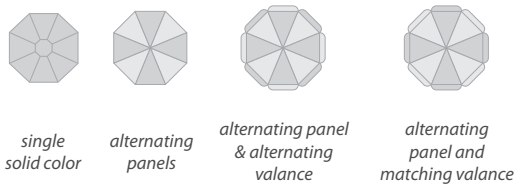

lifting system options

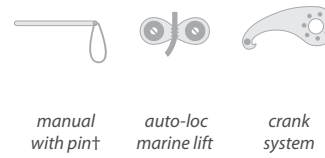

finial

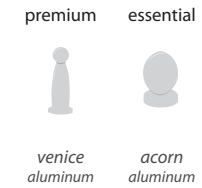

finish options:

ocean master classic

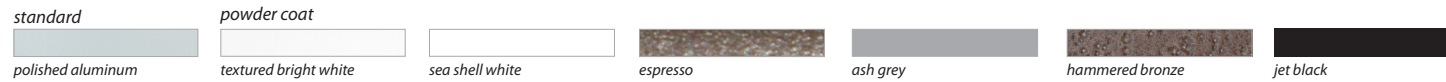

plantation classic

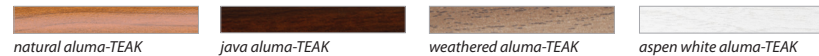

bay master classic

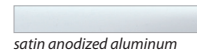

vineyard classic



Double wind vent & fishtail profile only available on octagon & hexagon shapes