

GLISS MASTER — VINCENT VAN DUYSSEN 2015

1—
64



Gliss Master develops the concept of storage and space organisation. This approach permits maximum uniqueness and customisation. It is a tailor-made design for a wide range of doors, accessories and finishes, which creates systems adapted to individual needs. The Gliss Master range can be combined with accessories and different finishes, drawing on the components of each series to create exclusive solutions. The 2023 collection includes two new doors - Linear by Vincent Van Duysen and Blend by Rodolfo Dordoni, and a new set of accessories and interior customisations. It is a system that reflects the importance of a tailor-made approach for Molteni&C.

GLISS
MASTER—
VINCENT
VAN DUYSSEN
2015

FINISHES

Finishes	melamine structure	piqué melamine grain	fine melamine grain	melamine front	lunar	3D matt lacquer colours	glossy lacquer colours	glaze	woods	pewter colour/bronze/iris	Eco Skin	Blend fabric	coloured glass/etched coloured glass/mirror	glasses (see finishes)	3D etched bronze glass
----------	--------------------	----------------------	---------------------	----------------	-------	-------------------------	------------------------	-------	-------	---------------------------	----------	--------------	---	------------------------	------------------------

components	melamine structure	piqué melamine grain	fine melamine grain	melamine front	lunar	3D matt lacquer colours	glossy lacquer colours	glaze	woods	pewter colour/bronze/iris	Eco Skin	Blend fabric	coloured glass/etched coloured glass/mirror	glasses (see finishes)	3D etched bronze glass	
linear module and corner module	base/lid															
	back panel															only linear
wooden central partition																
wooden external side panel																
extension profile	central partition or side panel frame															
	frame or glass															central only transparent
FIND-ME door	finger recess															
	panel															
QUICK door				*												
START door										only hinged door						
"A FILO" door										only hinged door						
"A FILO" glass door	profile															
	glass															
BAMBOO door	profile															
	panel															
SMOOTH door	profile															
	panel															
HOLLOW door										only hinged door						
BLADE sliding door																
GRIP door																
NICHE door																
GLASS door	profile															
	glass															
SISTEMA 7 wood																
SISTEMA 7 glass	profile															
	glass															
LINEAR door																
LINEAR glass door	profile															
	glass															excluding net
BLEND door	door profiles															
	door panel															
	drawer front															only mirror
	top															

* with handle and extension profiles
side matched as per the table
(see p. 62 price list)

Molteni & C

2—
64

GLISS
MASTER—
VINCENT
VAN DUYSSEN
2015

FINISHES

Finishes

melamine structure piqué melamine melamine structure Eco Skin pewter colour/bronze/iris profile fine grain pewter colour/bronze/iris profile pewter colour/bronze/iris transp. glass grey saffiano melamine larix dark/ silver light chestnut and dark chestnut matt lacquer woods

internal fittings

shelf													
wooden drawer fronts H 126/190/382													
tray front (trouser holders/trinket trays)													
front for open drawers /pull-out trays													
glass drawer fronts/ glass shelf	profile												
glass shelf	glass												
drawer internal													
central dividing panels													
sweater and shirt holder module													
SOFT LINE internal fittings													
island drawer unit													
drawer unit													
Island with glass top													

Molteni & C

3—
64

colours

Melamine structure

YM larix dark
YA silver cembran
WW white
QC light chestnut
QS dark chestnut
QA ivory tatami
QG grey tatami

Melamine front

KA cartapaglia anthracite
KB cartapaglia white
KS cartapaglia silica
ZB silk chalk white
ZS silk silica
ZT silk dove grey
QC light chestnut
QS dark chestnut
QA ivory tatami
QG grey tatami

Matt lacquer

3D matt lacquer

Glossy lacquer

Coloured glass

Etched coloured glass

BC chalk white
PE pearl
DN dune
PL platinum
NE black
AT anthracite
SE mustard
SI silica
DO dolomite grey
AL clay
MK moka
CZ light blue grey
SA sand
RU ruby
PX pewter colour
RX copper
TO dove grey
PR petroleum blue
BG burgundy
LS london sky
SU stardust
ML moonlight
SP spice
PG pine green
AW almond white

Woods

EU eucalyptus
RF graphite oak

Eco Skin

grey
mink
hemp
ivory
dark brown
earth
arctic
taupe

Glasses

transparent
smoked
stopsol transparent
stopsol silver
stopsol bronze
stopsol
stopsol net

BLEND fabric

bark brown
moss green
olive green
oxide orange
vanilla

MODULARITY

Modularity - Structure

The widths 492 - 656 - 820 - 984 - 1312 - 464 (term. element) mm (19 3/8" - 25 7/8" - 32 1/4" - 38 3/4" - 51 5/8" - 18 1/4") include the left side panel. The total width of the composition will include the final panel of th. 30 mm (1 1/8").

Heights:

tot. H 2343 (92 1/4"), door 2313 (91"), int. 2253 (87 3/4"), sliding or flush sl. door inter. 2163 (85 1/8")
 tot. H 2439 (96"), door 2409 (94 7/8"), int. 2349 (92 1/2"), sliding or flush sl. door inter. 2259 (88 7/8")
 tot. H 2631 (103 5/8"), door 2601 (102 3/8"), int. 2541 (100"), sliding or flush sl. door inter. 2451 (96 1/2")

tot. H 2919 (114 7/8"), door 2889 (113 3/8"), interior 2829 (111 3/8"), only hinged

Assembly instructions

For the assembling of a sliding and a flush sliding door wardrobe a minimum space of 6 cm (2 3/8") is required considering the minimum height of the compartment.

Assembly of the corner element (for wardrobe with doors) requires a minimum extra height of 6 cm (2 3/8").

Assembly of a wardrobe in an alcove requires a minimum extra side space of 4 cm (1 5/8"). This space can be reduced to 15 mm by using special hardware provided on request for the side compartment. Surcharge per compartment.

This hardware may only be applied if there are open compartments, hinged doors (excluding SISTEMA 7) and wooden side panels.

For hinged door wardrobes with lighting systems and/or SISTEMA 7 doors this product requires a minimum height of 5 cm (2").

The height can be reduced to 15 mm by inspection on top cod. **PAISPC01** (see page 33 price list).

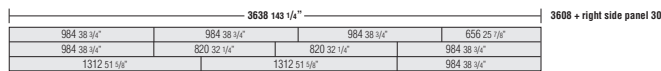
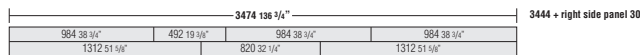
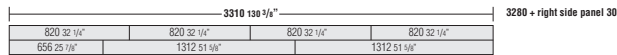
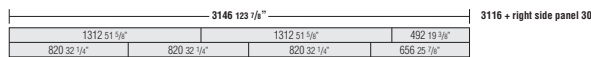
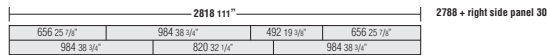
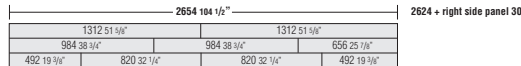
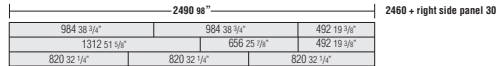
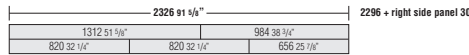
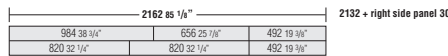
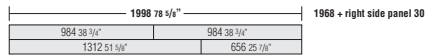
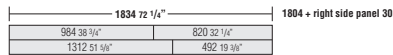
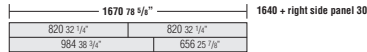
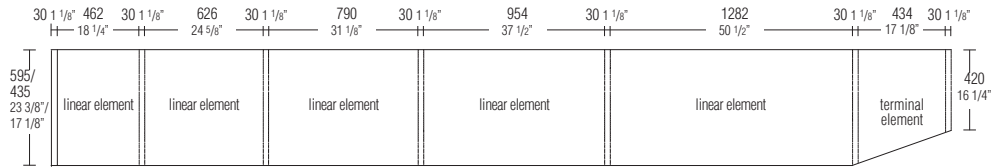

DOORS

START-HOLLOW hinged doors

applicable only on structures with wood sides

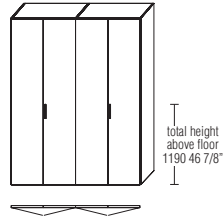

The pairs of hinged doors START and "A FILO" always have a handle mounted on the right door.

FIND-ME-QUICK-"A FILO"-BAMBOO hinged doors

applicable only on structures with wood sides

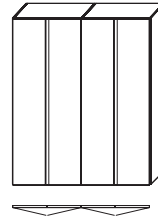

GRIP-BLEND hinged doors

applicable only on structures with wood sides

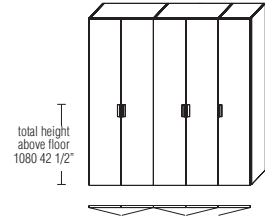

NICHE doors

applicable only on structures with wood sides

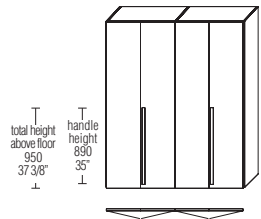

In the pairs of hinged doors W 815, 979 and 1307, are available 2 handles or handle only on right door.

LINEAR door

applicable only on structures with wood sides

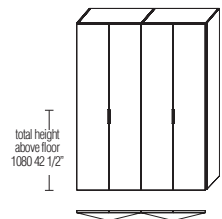

Hinged LINEAR doors are made with hinges concealed in the side panels

GLASS-SISTEMA 7 doors, th 35

applicable on all types of structures

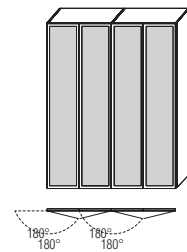

GLASS doors are made with 180° hinges built into the side (a Molteni exclusive)

Sliding doors

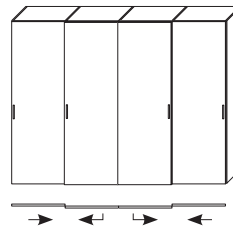
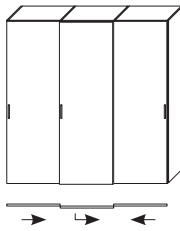
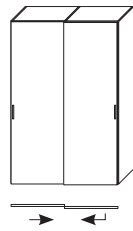

It is possible to make sliding door wardrobes with doors of the following types:
- QUICK
- START
- "A FILO"
- GRIP
- BLADE

It is possible to make the external sliding door with two handles if using the QUICK, "A FILO" or BLADE door (full-height handle) and applying the surcharge

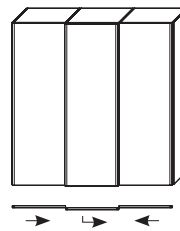

Detail of side panel with extension profile

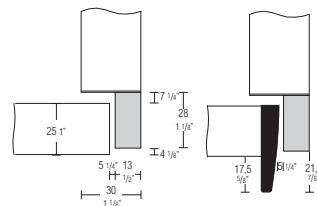

with BLADE door

Flush sliding doors

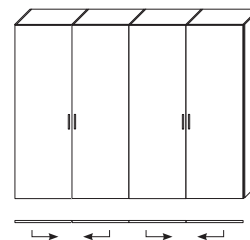
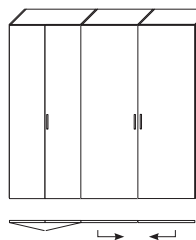
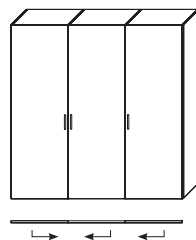

DOORS

155° opening (only for compartments with wooden sides)

On **FIND-ME - QUICK - START - "A FILO" - BAMBOO - HOLLOW - GRIP - NICHE - BLEND** doors it is also possible to use 155° opening hinges, with an extra charge per individual door. In this case, it is necessary to take special care in inserting internal drawer units, trinket trays and devices.

155° hinges cannot be used on 'A FILO doors (mirror and glass) with width over W 487.

It is also necessary to comply with the diagrams provided here.

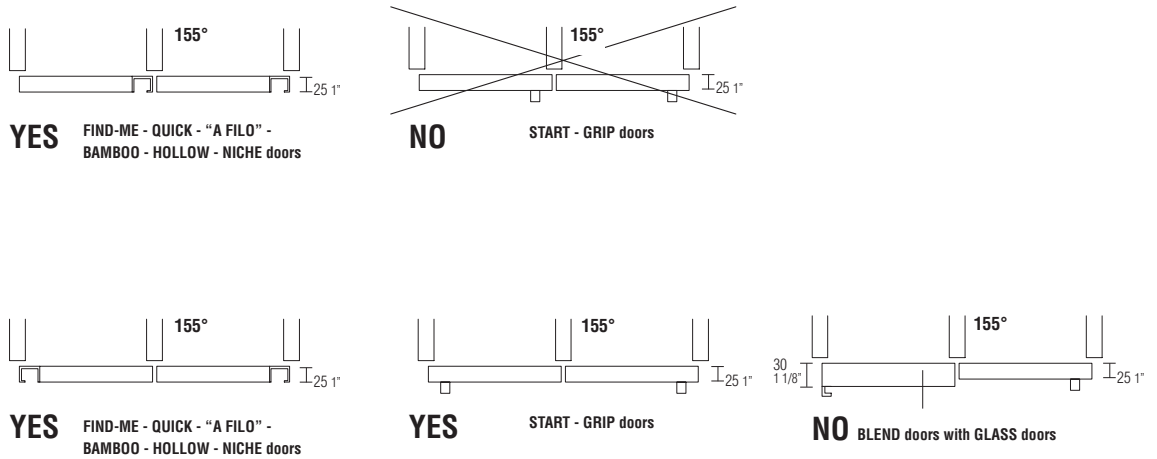

Hinged doors with key lock

For the hinged doors specified, a key lock can be fitted to order. The additional cost for one or two doors. It can even be fitted on a terminal element or a corner element (in compliance with the handle installation rules).

For doors with a lock, the internal drawer units must be suspended.

Installation of only the lock can be requested, without a handle, always considering the price of the START doors and the additional cost of the lock.

For LINEAR doors, see page 102 price list because they have special locks.

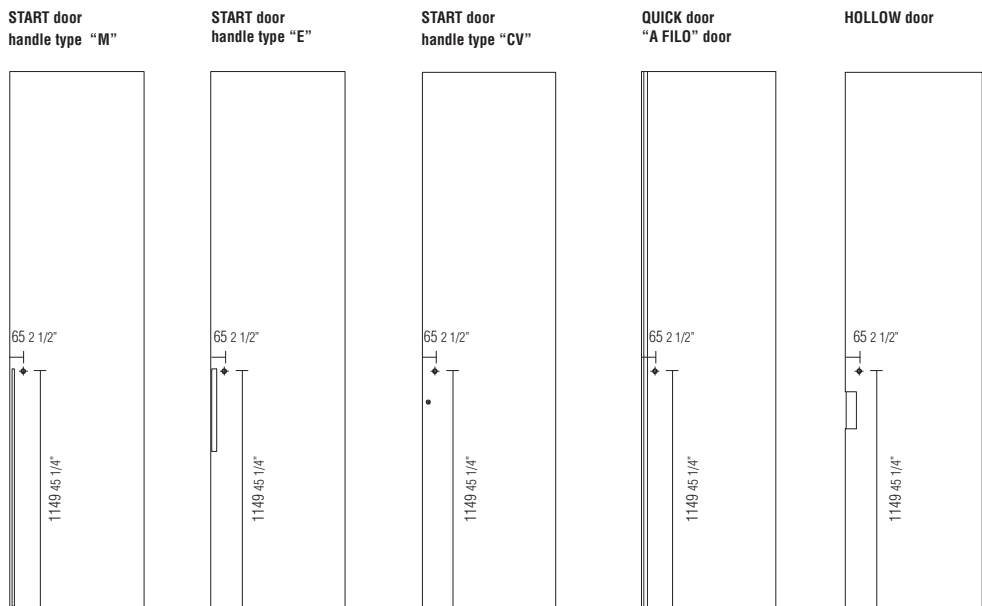

SISTEMA 7

A new folding opening system with a patented mechanism which makes it possible, in the 180° version, to open the unit entirely. The mechanism, light and silent, does not require tracks and therefore allows use of the full height.

The hinged doors enable 180° opening and wardrobe width made to order; the special hinge pins are anchored to the base and the cover.

Anyhow, SISTEMA 7 hinge doors can be used (see p. 14/15 price list).

The 90° opening, on the other hand, is an intermediate solution that can solve design problems while maintaining a uniform design.

The thickness of the wood and glass door are 35 mm.

SISTEMA 7 can be applied to all Gliss Master structures with wood, glass or frame sides, but cannot be used with other Gliss Master doors.

The 90° and 180° folding door is applied to modules with width 790 and 954, while the hinged door is applied to single modules 380/462/626, double modules 790/954/1282 and the corner unit (see pag. 16 price list).

The 380 mm unit is specific for SISTEMA 7 with hinged door.

Reductions

90° and 180° folding openings can be reduced in height only.

180° hinged openings can be reduced in height and in width up to 405 mm.

Notes

The side panels follow the same logic as Gliss Master (see drawing ●).

★ = 180° Hinged (necessary for 180° opening and for wardrobes with width made to order)

90° Folding opening

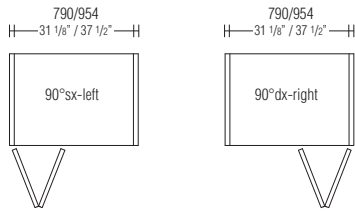

If the 90° folding door is on an end unit with external door, provide filler:
50 mm (790 compartment)
120 mm (954 compartment)

180° Folding opening

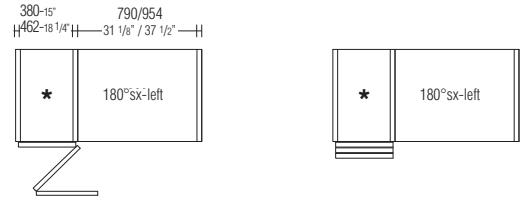

Mixed 90° / 180° Folding openings

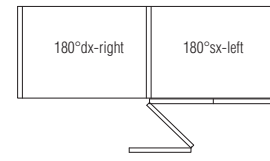
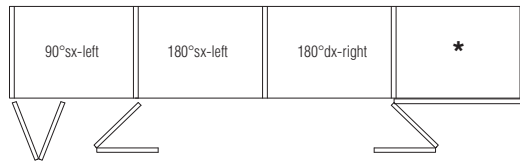

180° Corner opening

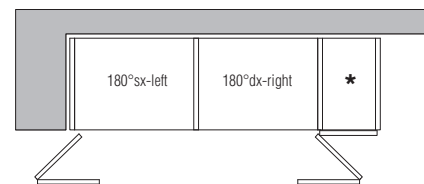
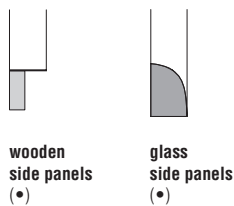
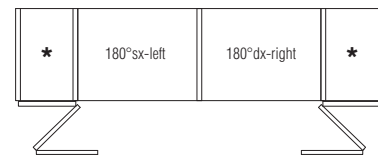
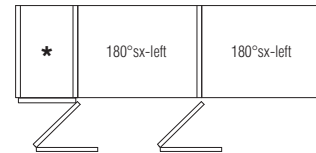
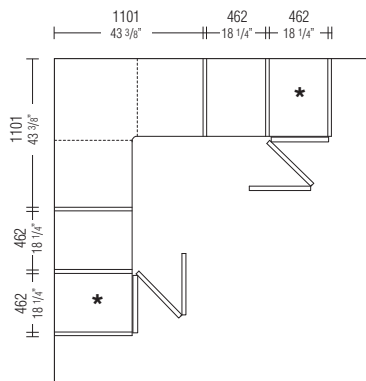

CORNER ELEMENT

Open corner element P 595

The open corner element is supplied complete with base, top and backs (melamine faced structure, piqué or fine grain). The melamine-faced, frame or glass central partitions must be inserted between the corner element and the adjacent modules.
The open corner element can also receive a side panel to close the composition.

Doors can be applied to the open corner element by following the rules below:
- GLASS door (180°) on corner element 1282x1282 / 1101x1101 with all types of side panels (wood, frame or glass);
- SISTEMA 7 door (180° hinged and 180° folding) only on corner element 1101x1101 with all types of side panels;
- QUICK and "A FILO" door (155°) only on corner element 1101x1101 with wooden side panels.
- LINEAR door only on corner element 1101x1101 with wooden side panels.
Compartments adjacent to the corner element can be either open or closed with the same door model.

Notes

The shelf is not included in the price of the corner element.
LED lighting bars can be applied to the shelves and lids, as shown in the drawing below.

Reductions

The corner element can be reduced in height, width and depth.
Width reduction can only be performed on one side or on both sides up to a minimum width of 1101 mm (see procedures on page 32 price list.).

Depth reduction can be performed on either one or two sides up to a minimum depth of 435 mm. If only one side is reduced, it will be the one with the longer shelves (*).



Solution with GLASS door

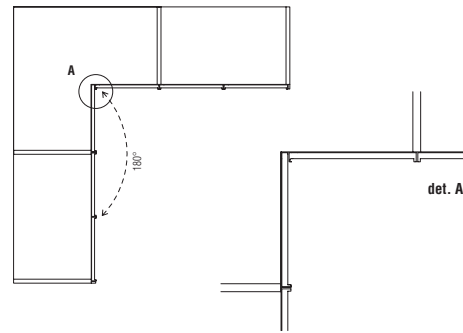
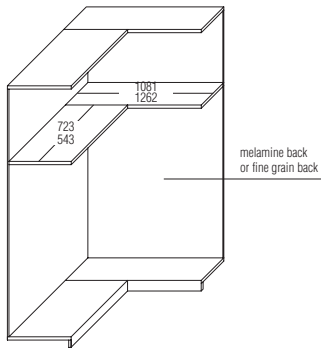

Solutions with SISTEMA 7 (only for corner element 1101x1101)

180° folding

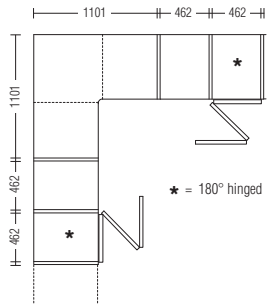

180° hinged

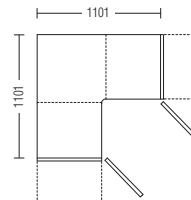

Solution with QUICK, "A FILO" and LINEAR doors* (only for corner element 1101x1101)

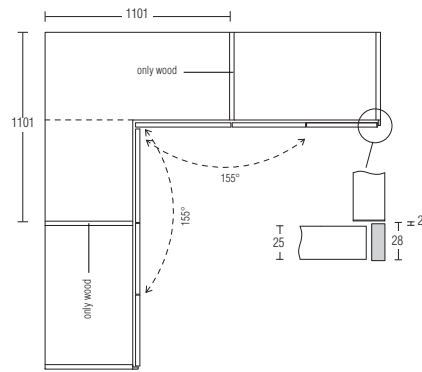

The corner element can be fitted with shelves and clothes rails, or with this solution of drawer units that have a central partition H 1158 where the desired drawer unit can be inserted. The drawer unit can be with fronts W 420 or 584.

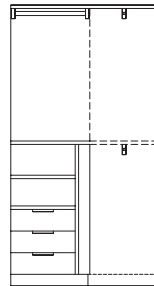
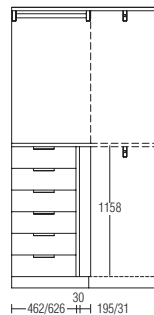
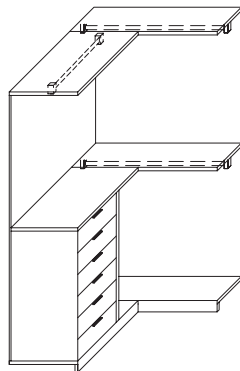

No type of drawer unit can be inserted with frame or glass sides

Placing LED lighting bars

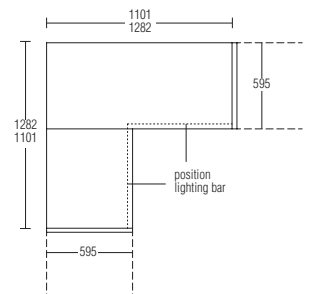

STRUCTURE

Structure for walk-in closet

In version **A**, the structure (base, lid, central partitions, back and side panels) is in melamine, in the same finish as the structure.

The back piece can also be provided in fine grain finish or in glass max H 2631.

The side panels are always provided without extension profile (see detail).

In version **B**, the central partitions and sides are made with an aluminium frame with pewter colour, bronze or iris finish, with or without glass.

Base, lid and back piece are in melamine, in the same finish as the structure.

The back piece can also be provided in fine grain or glass finish max H 2631.

Horizontal tags on the base and lid are made in a pewter colour, bronze or iris finish like the side frames.

In version **C**, given the presence of frame sides in pewter colour finish, the central and side partitions in melamine are also made with front tags in pewter colour, bronze or iris, considering the specific price.

Reductions

See procedures on page 32 price list.

** Notes

The central melamine sides with front profile, frame and glass are available with an Eco Skin insert, only for use in walk-in closets

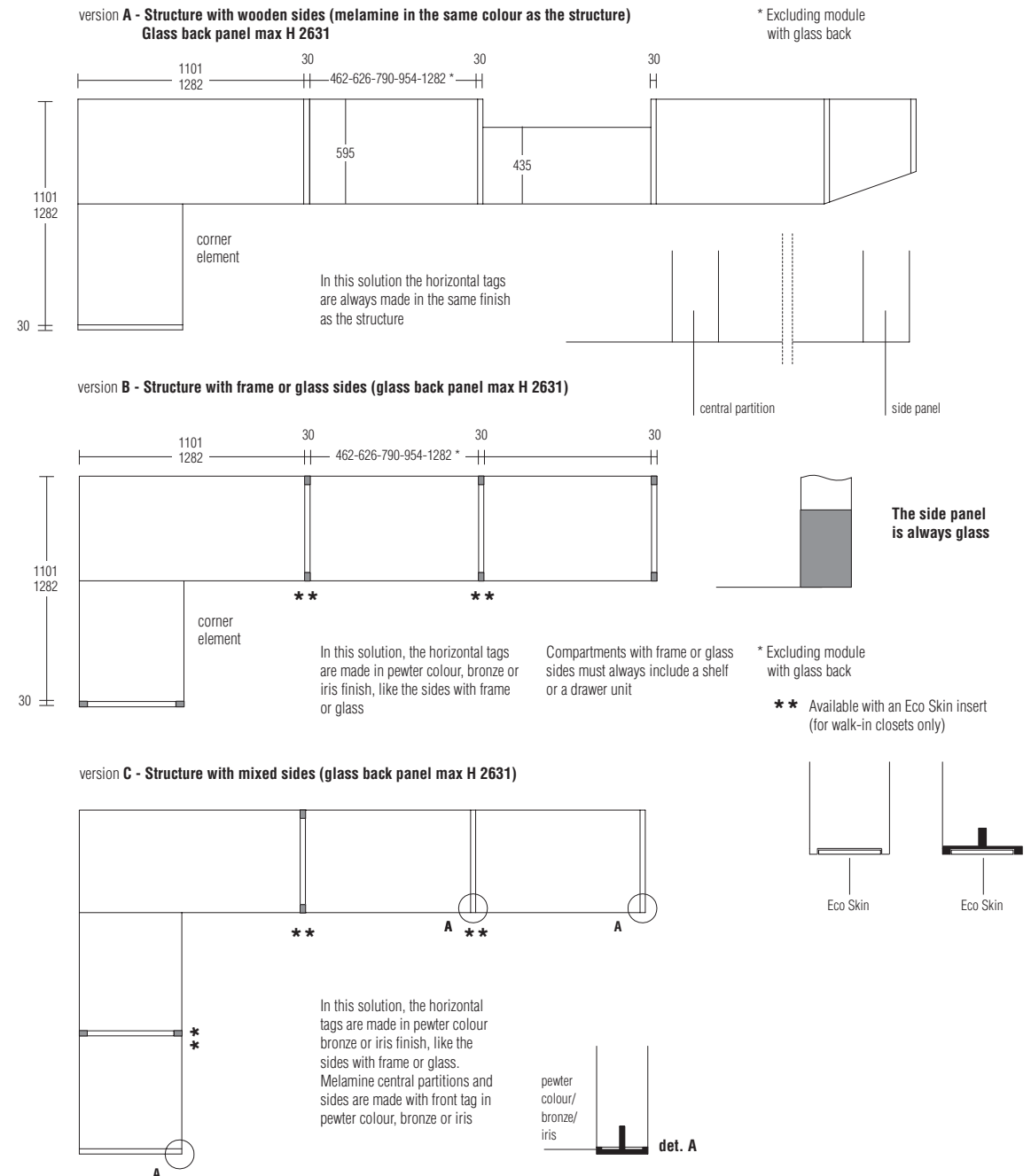

STRUCTURE

Linear modules

Linear modules are made up of a base and lid always made in melamine in the same finish as the structure.

The back is available in the three versions indicated below.

A1 and **A2** can be reduced in height, width and depth if closed by sides and doors that are compatible with the requested reductions.

A3 can be reduced only in height.

Central partitions

These are available in melamine, in the same finishes as the structure, frame and glass. The melamine version can be reduced in height and depth.

The frame and glass versions can be reduced only in height.

Compartments with frame or glass sides must always include a shelf or a drawer unit.

A version with an Eco Skin insert is available for use in walk-in closets.

Side panels

These are available in melamine, in the same finishes as the structure, frame and glass. The melamine version can be reduced in height and depth.

The side exterior is available also in matt lacquer, glossy lacquer or wood finish (vertical grain), as shown on p. 8 price list.

The standard finish on side panels is an extension profile in the coloured matt lacquer, pewter colour, bronze, iris (to be specified in the Order). The extension profiles for glossy lacquer or wood side panels always match the side panels of the same finish.

The frame and glass versions can be reduced only in height.

Compartments with frame or glass sides must always include a shelf or a drawer unit.

Reductions

See procedures on page 32 price list.

Molteni & C

10—
64

A1 - Melamine back

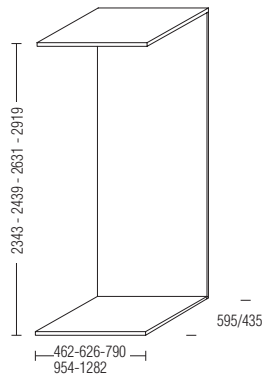

A1

Base, lid and back made in melamine finish matching the structure. The back is available also in piqué

A2 - Back in fine grain, matt lacquered colours, wood

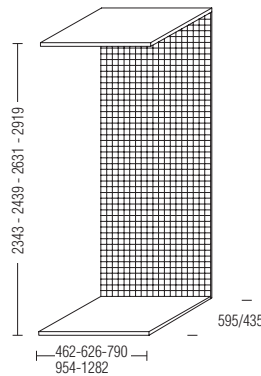

A2

Base and lid made in melamine finish matching the structure. Back in fine grain, matt lacquered colours or wood.

A3 - Glass back

(only hinged GLASS, closet and SISTEMA 7 glass)

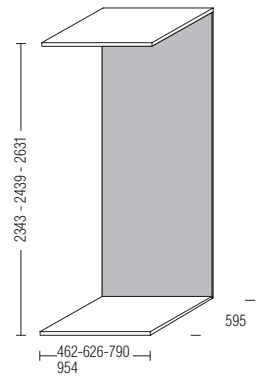

A3

Base and lid made in melamine finish matching the structure. It is possible to produce single finished modules W 790/954 with lateral pieces in glass by using the glass lids (see p. 57 price list)

Central partitions, th 30

Warning:

frame sides and glass sides will only have holes at the position of the shelves. Complete hole series at regular intervals 96 mm will involve an extra charge per side.

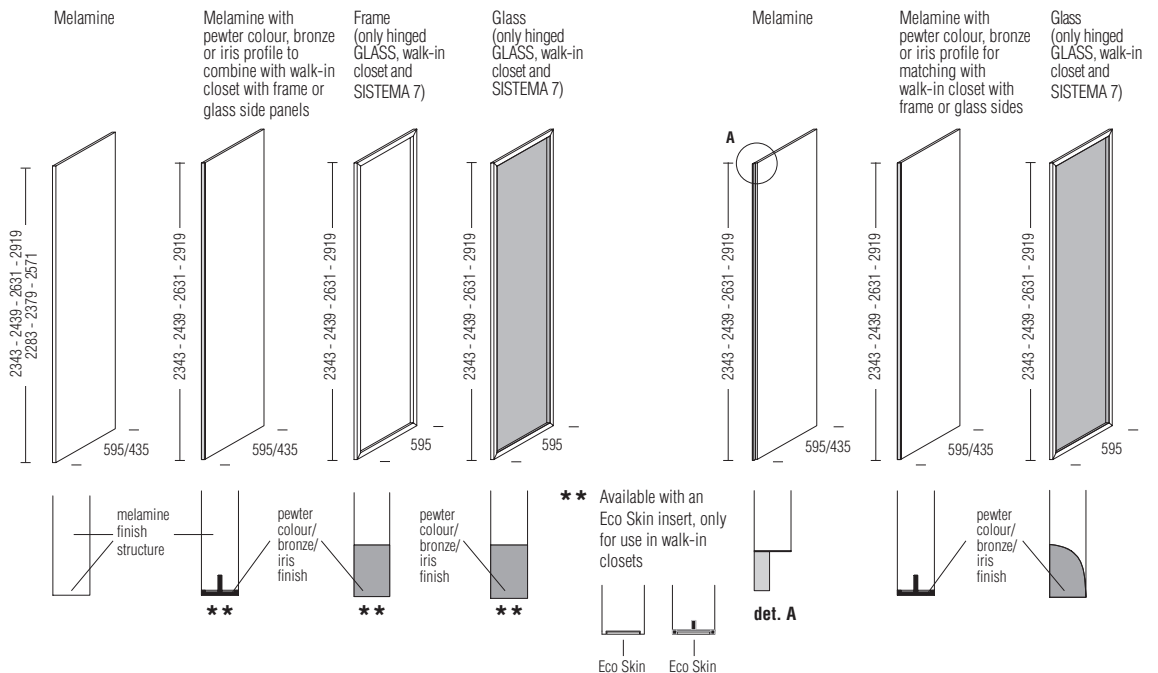

TWO-SIDED CORNER WARDROBE COMPOSITIONS WITH OUTWARD SWING DOORS

Many of the solutions described below can be created with Gliss Master. These layouts can be installed either with or without the external corner module.

** For this side, please consider the wooden side panel surcharge.

Solution A:
Outward swing doors
(NO glass back panels)

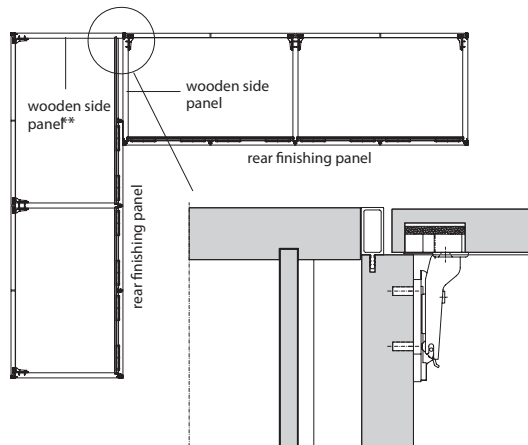

Solution B:
Outward swing door + Walk-in Closet
(NO glass back panels)

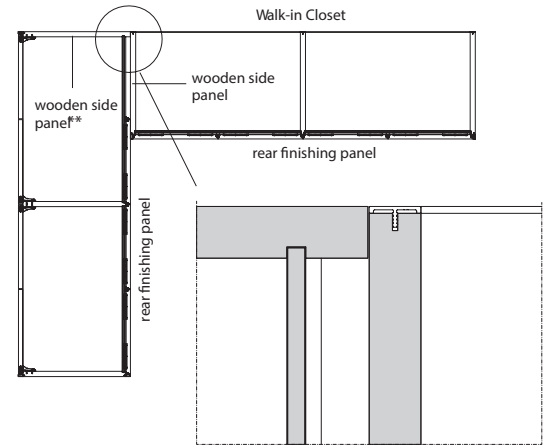

Solution C:
Outward swing door + Inward swing door
(example with glass back panels)

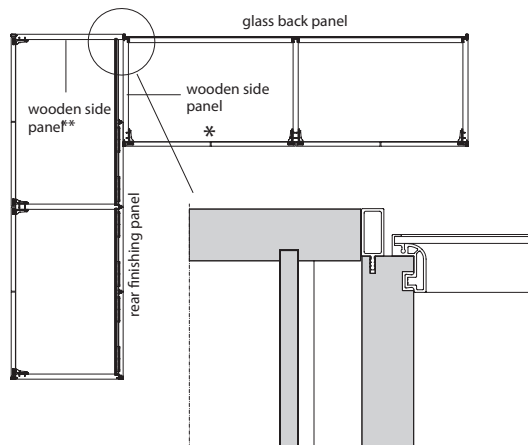

Solution D:
Outward swing door + Inward swing door
(example with rear finishing panel)

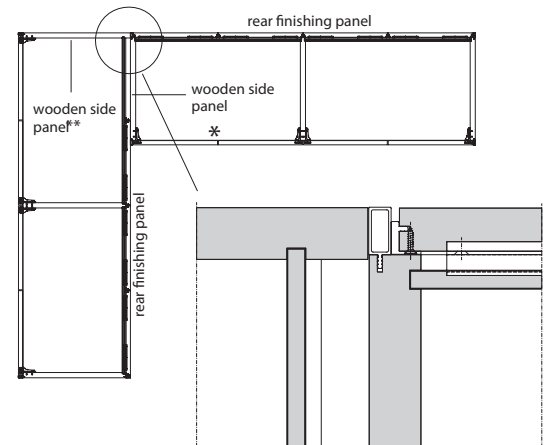

* This compartment can be closed with a QUICK, "A FILO" and NICHE door (vertical and horizontal).
For glass backs, drawer units are mandatory for compartments with frame or glass sides.
For melamine structure, pique, matt lacquered colours, wood or fine grain backs, use drawer units that are narrower than the module.

EXTERNAL CORNER UNIT

External corner unit

- It can be either open or fitted with doors.
- It is always secured to the melamine central partitions of the adjacent wardrobes.
- The front profile can have a matt lacquered, pewter colour, bronze and iris finish.
- Height, width and depth can be reduced.
- The external corner unit can be closed in all hinged door models.

Reductions

The external corner unit can be reduced in height, width and depth.

* For this side, please consider the wooden central partition surcharge.

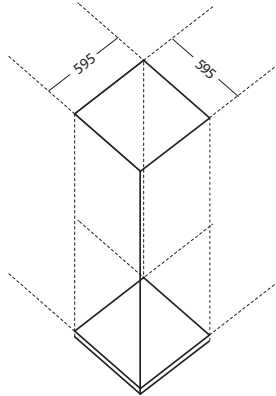

12—
64

Solution A:
with Doors

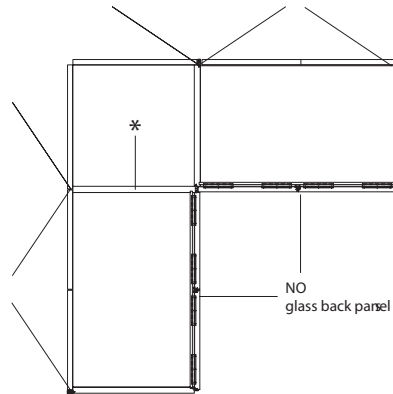

Solution C:
Doors and Walk-in Closet

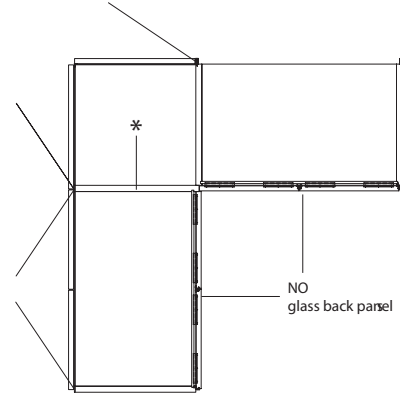

Solution B:
Walk-in Closet

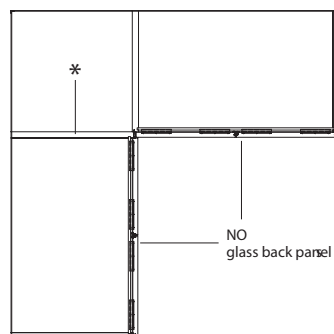

Solution D:
Doors and Walk-in Closet

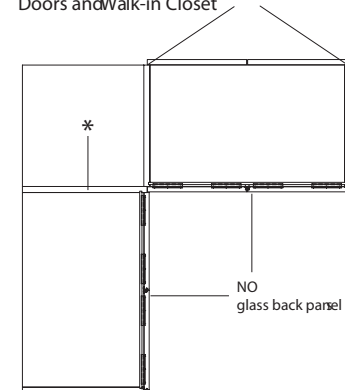

WARDROBE REDUCTIONS

Structure reductions

Type of reduction	height	width	depth
Linear modules D 595 mm <small>melamine, fine grain, matt lacquered colours, woods back</small>	per millimetre	per millimetre	min -20 mm max -256 wardrobe / flush sliding ward. max -160 mm
Linear modules D 595 mm <small>glass back</small>	per millimetre	no reductions	no reductions
Linear modules D 595 mm for BLEND drawers	no reductions	no reductions	no reductions
Linear elements D 435 mm	per millimetre	per millimetre	min -20 mm max -96 mm
Corner element for wardrobe with doors	per millimetre	no reductions	no reductions
Open corner element	per millimetre	1 side up to 1101 x 1282	1 side up to mm 435 (see note page 16 price list)
		2 sides up to 1101 x 1101	2 sides up to mm 435
Terminal element	per millimetre	no reductions	no reductions
Wooden central partition or side panel	per millimetre		reductions depend on linear modules
Frame or glass side panel or central partition	per millimetre		no reductions
External corner unit	per millimetre	up to mm 435	up to mm 435

Door reductions

Type of reduction	height	width
Wooden hinged doors (FIND-ME - QUICK - START - BLEND - LINEAR - "A FILO" - HOLLOW - GRIP - NICHE)	per millimetre	per millimetre
"A FILO" glass hinged doors - Hinged doors SMOOTH	per millimetre	per millimetre
BAMBOO hinged doors	per millimetre	at -15 mm intervals
Wooden sliding doors (QUICK - START - "A FILO" - BLADE - GRIP)	per millimetre	ONLY doors W 979 and 1307 mm - reducible down to W 815 mm
"A FILO" glass sliding doors	per millimetre	no reductions
Wooden flush sliding doors (QUICK - START - "A FILO" - HOLLOW - GRIP)	per millimetre	no reductions
Flush sliding doors W 1471 mm cannot be reduced.		
"A FILO" glass flush sliding doors	per millimetre	no reductions
LINEAR / GLASS doors	per millimetre	reducible down to W 405 mm
SISTEMA 7 wood hinged door	per millimetre	reducible down to W 405 mm
SISTEMA 7 wood folding door	per millimetre	no reductions
SISTEMA 7 glass hinged door	per millimetre	reducible down to W 405 mm
SISTEMA 7 glass folding door	per millimetre	no reductions
BLEND external drawer (depth cannot be reduced)	no reductions	no reductions

Reductions of internal fittings

Type of reduction	height	width	depth
Wood shelves		per millimetre	reductions depend on linear modules
Shelves with pewter colour profile		per millimetre	reductions depend on linear modules
Eco Skin shelves		per millimetre	reductions depend on linear modules
Glass shelves		per millimetre	reductions depend on linear modules
Clothes rails		per millimetre	
Central divider pieces	32 mm intervals		reductions depend on linear modules
Internal drawers / trinket trays, trouser holders and pull-out trays / grid with shirt and sweater holders / shoe rack shelves / pull-out shirt holders / SOFT LINE internal fittings / islands	no reductions	no reductions	no reductions
"Smart" drawer unit 2 drawers		per millimetre	no reductions
"Smart" drawer unit 3 drawers		per millimetre	no reductions
"Smart" drawer unit 4 drawers		per millimetre	no reductions

Horizontal and vertical light bars can be reduced with the supplementary charge included in the charge for cutting shelf and side panel.

SPECIAL PROCESSING - INSPECTIONS

**Inspection on lid
with removable panel
for 626/790/954/1282
compartments (only on
hinged door compartment)**

LED lights can also be
fitted on the top.
Only for compartments
with melamine sides.
Removable 10 th. panel
melamine finished structure

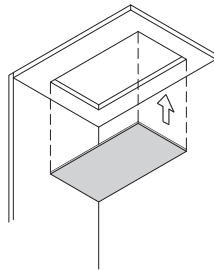

PAISPC01

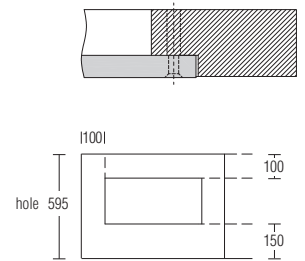

**Inspection on base
with removable panel
for 626/790/954/1282
compartments (only on
hinged door compartment)**

Only for compartments
with melamine sides.
Removable 10 th. panel
melamine finished structure

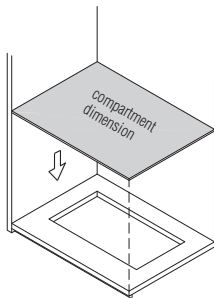

PAISPBA1

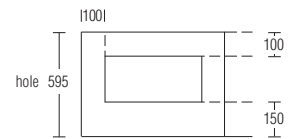

**Inspection on side panel
with removable panel**

Removable 10 th. panel
melamine finished structure.
Only one inspection possible
per side panel.

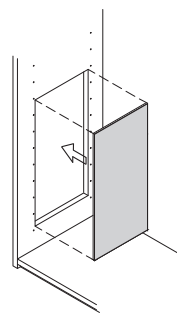

PAISPSP1

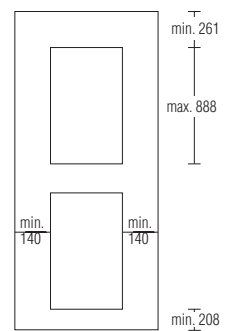

GLISS
MASTER—
VINCENT
VAN DUYSSEN
2015

REMOVABLE BACK PANEL

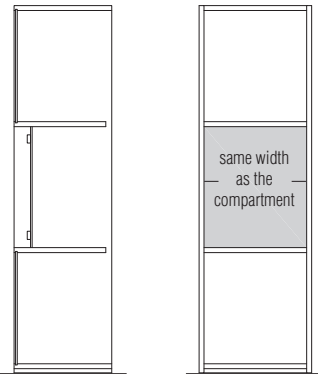

The removable back is made by dividing the back panel's structure, and adding two fixed shelves or 1 if starting from the base or top

Molteni & C

Type 1

Type 1

- Back cut
- Additional back panel at fixed price (for all finishes)
- Removable panel H max 1698 mm

melamine structure	matt lacquer	wood
W 462/626	W 462/626	W 462/626
W 790/954	W 790/954	W 790/954
W 1282	W 1282	W 1282

15—
64

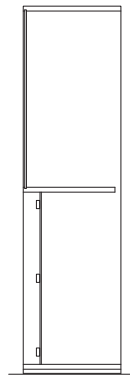

Type 2

Type 2

- Back cut
- Removable panel H max 1734 mm

melamine structure	matt lacquer	wood
W 462/626	W 462/626	W 462/626
W 790/954	W 790/954	W 790/954
W 1282	W 1282	W 1282

SPECIAL PROCESSING - SHAPING

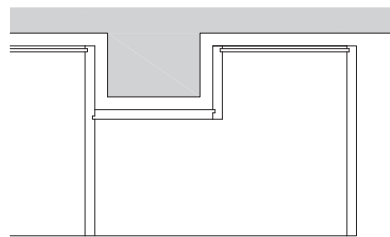
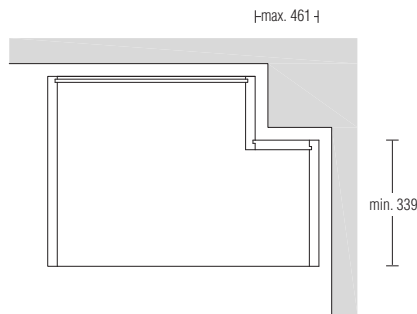
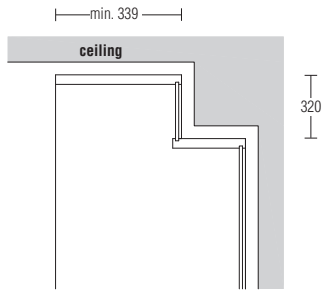

Only on hinged door compartment

- Costs to consider:
- Back cut
 - Lid cut
 - Fixed shelf with surcharge for cut (see page 133 price list for solid wood shelves)
 - Back, fixed price (for all finishes)

- Costs to consider:
- Back cut
 - Base/lid/shelf in solid wood
 - 2 cuts per shaped piece
 - 2 additional panels (melamine structure)
 - Possible cut in side

Notes

- Shaping in both height and width cannot be done on the same compartment.
- Confirmation to the customer of the feasibility of shaping will only be given after checking with the Molteni&C Technical Office.

Custom cuts for attics

Doors with slanting cut (only for wardrobes with solid wood sides)

When preparing the order, indicate heights H1 and H2, as well as the width L, as shown in the example.

The price for the slanting cut for each door is the same as cutting for a hinged door, as shown in the doors pages.

In this case a single module must be used with a QUICK, START, "A FILO", HOLLOW and GRIP hinged door, with the melamine facade and matt lacquered finishes, hinged on the higher side.

The structures can be standard or made to size.

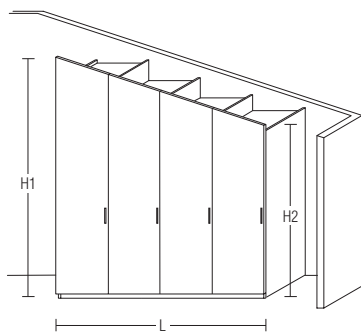

Standard or made to size doors (only for wardrobes with solid wood sides)

Double compartments with hinged doors can be used for this solution.

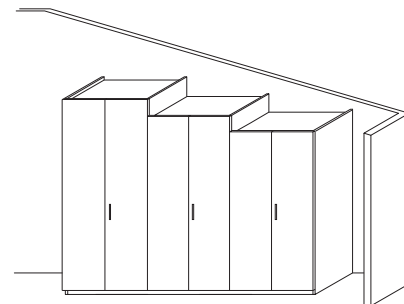

GLISS
MASTER—
VINCENT
VAN DUYSSEN
2015

**GLASS TOP FOR WARDROBES
FINISHED WITH ONLY ONE
COMPARTMENT W 790/954**

- To use only with:
- single linear module W 790 / W 954
(no modular arrangement is possible)
 - only with glass lateral pieces and glass back panel
 - clothes rod cannot be mounted on the lid
 - cannot be used with SISTEMA 7 doors

Glass finish
transparent glass
transparent stopsol glass
stopsol glass

Profile finish
pewter colour
bronze
iris

Increase valid for depths 595 - 23 3/8"



W 790 - 31 1/8"

W 954 - 37 1/2"

17—
64

FIND-ME door th 25

Door with full height vertical finger recess included in the door thickness.
The door is available in a hinged version in wood.

All the hinged doors have cushion-closing hinges.

Hinges with 155° opening can be used and a key lock can be installed on hinged doors.

The FIND-ME door can be made with LINEAR invisible hinges for matt lacquered colours, 3D matt lacquer, lunar, and wood finishes with a cost supplement per door.

Reductions

FIND-ME doors can be reduced as shown on p. 32 price list.

Notes

With 3D lacquer, glaze, and lunar surfaces, the outside of the side panel can be made with a matt lacquer finish or a laminate faced finish like the internal structure.

To match the glaze finish door, we advise the side exterior finish in dolomite grey matt lacquer with finger recess and extension profiles in pewter colour, bronze or iris.

To match the lunar finish door, we advise the side exterior finish in clay matt lacquer with finger recess and extension profiles in pewter colour, bronze, iris.

FIND-ME wooden door

matt lacquer colours
glossy lacquer colours
vertical grain wood
3D matt lacquer colours
glaze
lunar

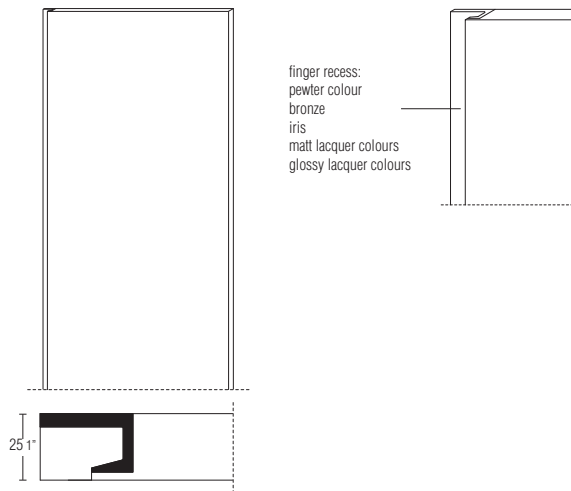

finishes

	matt lacquer colours	lunar	vertical grain wood	glossy lacquer colours	glaze	3D matt lacquer colours
hinged doors						
width 487 (19 1/8")						
w. 651 (25 5/8")/608 (23 7/8")						
width 815 (32 1/8")						
width 979 (38 1/2")						
width 1307 (51 1/2")						
door for terminal element						

QUICK door th 25

Door with full height handle included in the door thickness.

All the hinged doors have cushion-closing hinges.
The sliding door have a shock absorber mechanism which allows them to open and close softly.
Hinges with 155° opening can be used and a key lock can be installed on hinged doors (see page 53 price list).

Reductions

QUICK doors can be reduced as shown on p. 32 price list.

Notes

Sliding doors and flush sliding doors are not available in H 2889.

**With door in tatami melamine and chestnut finish, it is possible to make the structure and side panel in the same finish as the doors.
Side extension profiles are made in the same finish as the handle.
With cartapaglia and silk finished doors, the side panel exterior can be made with a finish in matt lacquered colours or a melamine finish like the internal structure.**

QUICK door

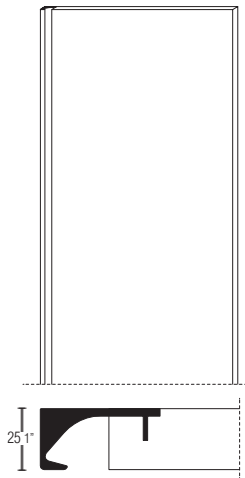

FINISHES TO MATCH THE QUICK DOOR

DOOR PANEL	PROFILE HANDLE/ DOOR EXTENSION	EXTENSION PROFILE SIDE PANEL
Ivory Tatami	RAL7032	RAL7032
Grey Tatami	RAL7039	RAL7039
Light Chestnut Dark Chestnut White cartapaglia Silica cartapaglia Anthracite cartapaglia Chalk white silk Silica silk Dove grey silk Ivory Tatami Grey Tatami	Epoxy finish Bronze or Epoxy finish Pewter Colour or Epoxy finish Iris	Epoxy finish Bronze or Epoxy finish Pewter Colour or Epoxy finish Iris

For handles matt lacquered in color with cartapaglia, silk and tatami melamine use "A FILO" doors

hinged doors

width 487 (19 1/8")	
w. 651 (25 5/8") 608 (23 7/8")	
width 815 (32 1/8")	
width 979 (38 1/2")	
width 1307 (51 1/2")	
door for terminal element	
corner unit 1101x1101	

sliding doors

width 815 (32 1/8")	
width 979 (38 1/2")	
width 1307 (51 1/2")	

flush sliding doors

width 815 (32 1/8")	
width 979 (38 1/2")	
width 1307 (51 1/2")	

START door th 25

Door with handles mounted on the front.

All the hinged doors have cushion-closing hinges.
The sliding door have a shock absorber mechanism which allows them to open and close softly.
Hinges with 155° opening can be used and a key lock can be installed on hinged doors (see page 53 price list).

The START door can be made with LINEAR invisible hinges for melamine front, matt lacquered colours, 3D matt lacquer and wood finishes with a cost supplement per door.

Reductions

START doors can be reduced as shown on p. 32 price list.

Notes

Sliding doors and flush sliding doors are not available in H 2889.

With melamine front, 3D lacquer and glaze finishes, the outside of the side panel can be made with a matt lacquer finish or a melamine finish like the internal structure.

To match the glaze finish door, we advise the side exterior finish in dolomite grey matt lacquer with handle and extension profiles in pewter colour, bronze or iris.

START door

melamine cartapaglia
tatami melamine
melamine silk
chestnut melamine
matt lacquer colours
3D matt lacquer colours
glaze
glossy lacquer colours
vertical grain wood

Type "E" standard

Pewter colour structure with front insert:
matt lacquer colours
woods

Structure and front insert:
bronze
pewter colour
iris

Type "M" surcharge each

Finish
pewter colour
bronze
iris

Type "CV" standard ONLY for hinged opening

Finish
pewter colour
bronze
iris

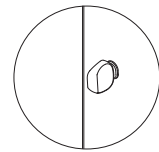
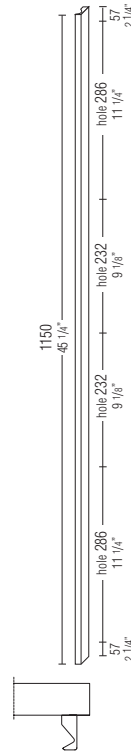
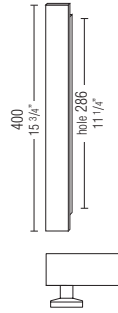
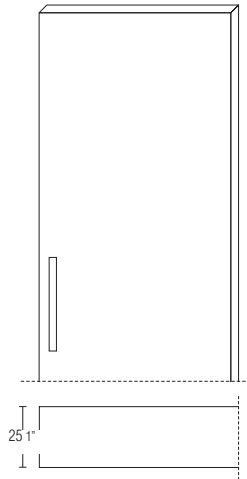

finishes

	melamine front	matt lacquer colours	vertical grain wood	glossy lacquer colours	glaze	3D matt lacquer colours
hinged doors						
width 487 (19 1/8")						
w. 651 (25 5/8")/608 (23 7/8")						
width 815 (32 1/8")						
width 979 (38 1/2")						
width 1307 (51 1/2")						
door for terminal element						
sliding doors						
width 815 (32 1/8")						
width 979 (38 1/2")						
width 1307 (51 1/2")						
width 1471 (57 7/8")						
flush sliding doors						
width 815 (32 1/8")						
width 979 (38 1/2")						
width 1307 (51 1/2")						
width 1471 (57 7/8")						

“A FILO” door th 25

Door with full-height handle included in the thickness of the door.
The door is available in the versions wood and glass.

All the hinged doors have cushion-closing hinges.
The sliding door have a shock absorber mechanism which allows them to open and close softly.
Hinges with 155° opening can be used and a key lock can be installed on hinged doors (see page 53 price list).

The “A FILO” door can be made with LINEAR invisible hinges for melamine front, matt lacquered colours, 3D matt lacquer and wood finishes with a cost supplement per door.

Reductions

“A FILO” doors can be reduced as shown on p. 32 price list.

Notes

Sliding doors and flush sliding doors are not available in H 2889.
Glass hinged doors are not available in H 2889.
Flush sliding glass doors cannot be used in compositions with 3 doors.

With surfaces in cartapaglia melamine, silk, 3D lacquer, and glaze, the outside of the side panel can be made with a matt lacquer finish or melamine like the internal structure.

To match the glaze finish door, we advise the side exterior finish in dolomite grey matt lacquer with “a filo” handle (full height) and extension profiles in pewter colour, bronze or iris.

“A FILO” wooden door

melamine cartapaglia
melamine silk
melamine tatami
chestnut melamine
matt lacquer colours
3D matt lacquer colours
glossy lacquer colours
vertical grain wood
glaze

“A FILO” glass door

Glass:
coloured
etched coloured
mirror

Profile and “a filo” handle:
pewter colour
bronze
iris

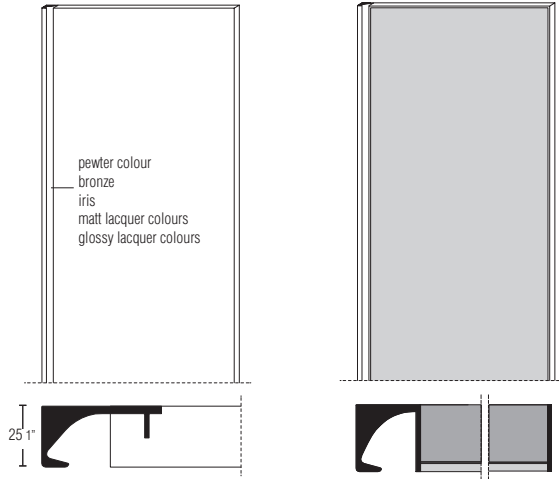

finishes

	melamine front	matt lacquer colours	vertical grain wood	glossy lacquer colours	coloured glass/ etched coloured glass/ mirror	glaze	3D matt lacquer colours
hinged doors							
width 487 (19 1/8")							
w. 651 (25 5/8")/608 (23 7/8")							
width 815 (32 1/8")							
width 979 (38 1/2")							
width 1307 (51 1/2")							
door for terminal element							
corner unit 1101x1101							
sliding doors							
width 815 (32 1/8")							
width 979 (38 1/2")							
width 1307 (51 1/2")							
width 1471 (57 7/8")							
flush sliding doors							
width 815 (32 1/8")							
width 979 (38 1/2")							
width 1307 (51 1/2")							
width 1471 (57 7/8")							

SMOOTH door th 25

Door covered in Eco Skin or BLEND fabric in the colours in the Molteni range, featuring a full-height handle recessed in the width of the door and a perimeter profile that outlines the edge.

All the hinged doors have cushion-closing hinges.
Hinges with 155° opening can be used.

Reductions

SMOOTH doors can be reduced as shown on p. 32 price list.

Notes

With Eco Skin or BLEND fabric surfaces, the side panel exterior can be made with a matt lacquer finish or a melamine finish like the internal structure.

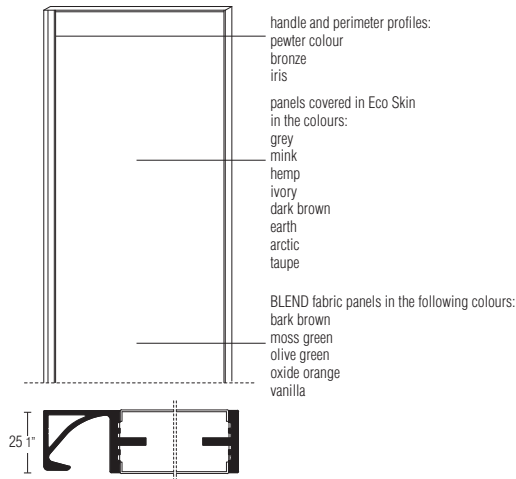

finishes

Eco Skin /
BLEND fabric

hinged doors

width 487 (19 1/8")	
w. 651 (25 5/8")/608 (23 7/8")	
width 815 (32 1/8")	
width 979 (38 1/2")	
width 1307 (51 1/2")	
door for terminal element	

BAMBOO door th 25

Door covered in quilted Eco Skin in the colours of the Molteni range, characterized by a full-height handle recessed in the thickness of the door and by a perimeter profile that defines its contour.

All the hinged doors have cushion-closing hinges.
Hinges with 155° opening can be used.

Reductions

BAMBOO doors can be reduced as shown on p. 32 price list.

With fronts in Eco Skin finish, the outside of the side panel can be made with matt lacquer finish or in melamine in the same finish as the inside structure.

BAMBOO door

Handle and perimeter profiles:
pewter colour
bronze
iris

Panels covered in Eco Skin
in the colours:
grey
mink
hemp
ivory
dark brown
earth
arctic
taupe

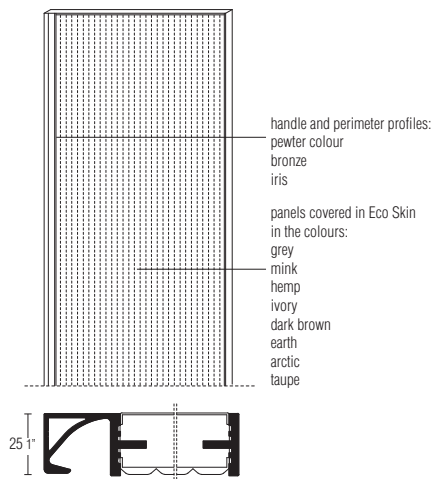

finishes

hinged doors Eco Skin

width 487 (19 1/8")	
w. 651 (25 5/8") 608 (23 7/8")	
width 815 (32 1/8")	
width 979 (38 1/2")	
width 1307 (51 1/2")	
door for terminal element	

HOLLOW door th 25

Door characterized by the handle recessed in the thickness of the door.

All the hinged doors have cushion-closing hinges.
The sliding door have a shock absorber mechanism which allows them to open and close softly.
Hinges with 155° opening can be used and a key lock can be installed on hinged doors (see page 53 price list).

The HOLLOW door can be made with LINEAR invisible hinges for melamine front, matt lacquered colours, and wood finishes with a cost supplement per door.

Reductions

HOLLOW doors can be reduced as shown on p. 32 price list.

Notes

Flush sliding doors are not available in H 2889.

With the fronts in melamine front finish and glaze, the exterior of the side panel can be in matt lacquer or melamine finish like an internal structure.

To match the glaze finish door, we advise the side exterior finish in dolomite grey matt lacquer and the extension profile in the same finish as the handle (pewter colour, bronze or iris).

HOLLOW door

Panel:
melamine cartapaglia
melamine tatami
melamine silk
chestnut melamine
matt lacquer colours
glaze
glossy lacquer colours
vertical grain wood

Handle:
pewter colour
bronze
iris

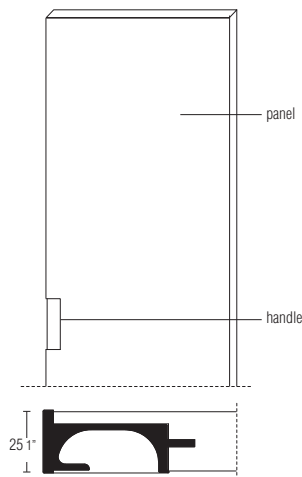

finishes

	melamine front	matt lacquer colours	glaze	vertical grain wood	glossy lacquer colours
hinged doors					
width 487 (19 1/8")					
w. 651 (25 5/8")/608 (23 7/8")					
width 815 (32 1/8")					
width 979 (38 1/2")					
width 1307 (51 1/2")					
door for terminal element					
flush sliding doors					
width 815 (32 1/8")					
width 979 (38 1/2")					
width 1307 (51 1/2")					

GLISS
MASTER—
VINCENT
VAN DUYSSEN
2015

BLADE sliding door th 25

Door with full-height handle.

The sliding system automatically aligns the door as it opens and closes.

Reductions

BLADE doors can be reduced as shown on p. 32 price list.

Notes

BLADE doors are not available with H 2889.

With the fronts in melamine front finish, the exterior of the side panel can be in matt lacquer or melamine finish like an internal structure.

BLADE sliding door

- melamine cartapaglia
- melamine tatami
- melamine silk
- chestnut melamine
- matt lacquer colours
- glossy lacquer colours
- vertical grain wood

25—
64

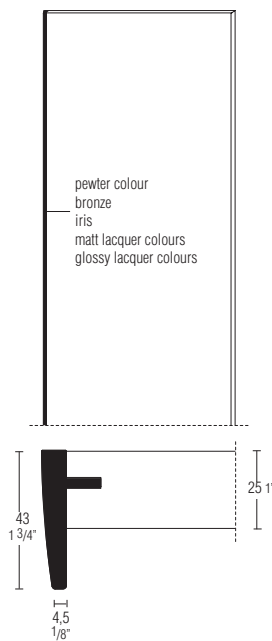

finishes

	melamine front	matt lacquer colours	vertical grain wood	glossy lacquer colours
sliding doors				
width 815 (32 1/8")				
width 979 (38 1/2")				
width 1307 (51 1/2")				
width 1471 (57 7/8")				

GRIP door th 25 design Vincent Van Duysen

Door with a handle applied laterally on the edge of the door.

All the hinged doors have cushion-closing hinges.
The sliding door have a shock absorber mechanism which allows them to open and close softly.

Hinges with 155° opening can be used on hinged doors (see page 53 price list).

The GRIP door can be made with LINEAR invisible hinges for melamine front, matt lacquered colours, and wood finishes with a cost supplement per door.

Reductions

GRIP doors can be reduced as shown on p. 32 price list.

Notes

Sliding doors and flush sliding doors are not available in H 2889.

In the pair of hinged doors, the handle is mounted on both doors in the pair.

With the fronts in melamine front finish, the exterior of the side panel can be in matt lacquer or melamine finish like an internal structure.

Handles finishes

pewter colour

bronze

iris

pewter colour/bronze/iris covered in Eco Skin in the colours (with surcharge per handle)

GRIP door
melamine cartapaglia
melamine tatami
melamine silk
chestnut melamine
matt lacquer colours
glossy lacquer colours
vertical grain wood

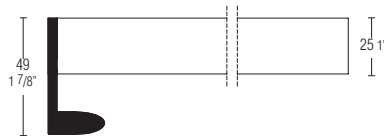
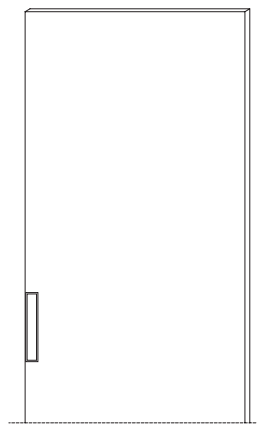

finishes

	melamine front	matt lacquer colours	vertical grain wood	glossy lacquer colours
hinged doors				
width 487 (19 1/8")				
w. 651 (25 5/8")/608 (23 7/8")				
width 815 (32 1/8")				
width 979 (38 1/2")				
width 1307 (51 1/2")				
door for terminal element				
sliding doors				
width 815 (32 1/8")				
width 979 (38 1/2")				
width 1307 (51 1/2")				
width 1471 (57 7/8")				
flush sliding doors				
width 815 (32 1/8")				
width 979 (38 1/2")				
width 1307 (51 1/2")				
width 1471 (57 7/8")				

GLISS
MASTER—
VINCENT
VAN DUYSSEN
2015

NICHE door th 25 design Vincent Van Duysen

Door with recessed handle.

All the hinged doors have cushion-closing hinges.

Hinges with 155° opening can be used on hinged doors (see page 53 price list).

Reductions

NICHE doors can be reduced as shown on p. 32 price list.

Handles finishes
pewter colour
bronze
iris

NICHE door
matt lacquer colours
glossy lacquer colours
vertical grain wood

27—
64

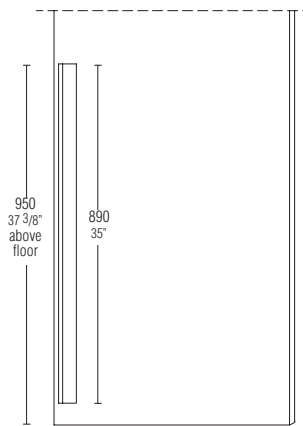

finishes

matt lacquer colours vertical grain wood glossy lacquer colours

hinged doors

	matt lacquer colours	vertical grain wood	glossy lacquer colours
width 487 (19 1/8")			
width 651 (25 5/8")/608 (23 7/8")			
width 815 (32 1/8")			
width 979 (38 1/2")			
width 1307 (51 1/2")			
door for terminal element			

NICHE horizontal door th 25 design Vincent Van Duysen

Door with recessed horizontal handle.

All the hinged doors have cushion-closing hinges.

Hinges with 155° opening can be used on hinged doors (see page 53 price list).

Reductions

NICHE horizontal doors can be reduced as shown on p. 32 price list.

Handles finishes
pewter colour
bronze
iris

NICHE horizontal door
matt lacquer colours
glossy lacquer colours

28—
64

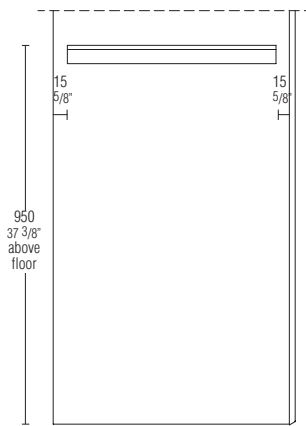

finishes

hinged doors	finishes	
	matt lacquer colours	glossy lacquer colours
width 487 (19 1/8")		
width 651 (25 5/8")/608 (23 7/8")		
width 815 (32 1/8")		
width 979 (38 1/2")		
width 1307 (51 1/2")		
door for terminal element		

BLEND door and external drawer design Rodolfo Dordoni

Hinged doors with perimeter profile characterised by a vertical decoration and the possibility of being combined with an external lower drawer.

29—
64

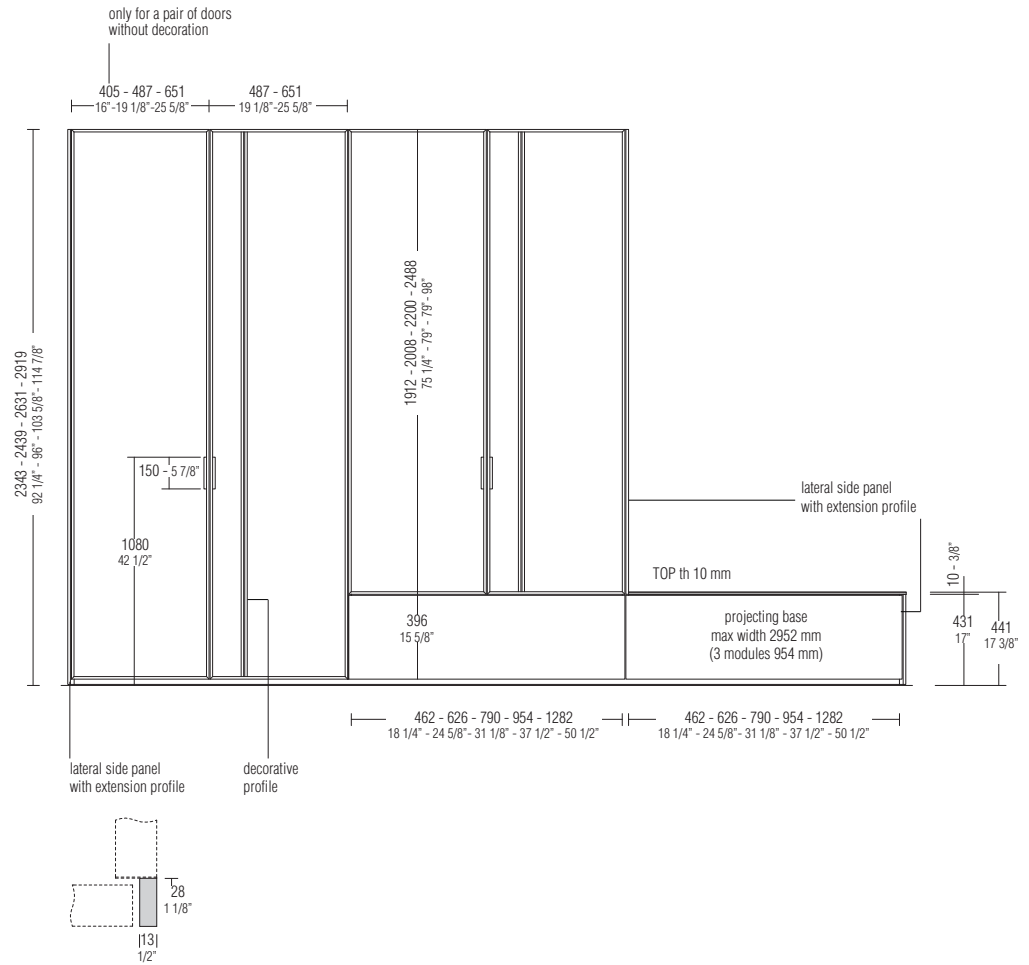

Technical information

- The hinged doors cannot be applied to frame or glass sides and to open corner units (1101x1101 - 1282x1282).
- The compartment above the drawer must always be closed with BLEND doors and cannot be equipped with central dividing sides.
- The protruding base, with one or more modules, must always be hooked to at least one side panel of the wardrobe.
- The decorative profile cannot be made on doors smaller than 487 mm wide.
- The drawer cannot be adjacent to the corner element (658x658).

BLEND door and external drawer design Rodolfo Dordoni

All hinged doors are equipped with soft closing hinges.
It is possible to use hinges with 155° opening on hinged doors.

Fabric colours

- bark brown
- moss green
- olive green
- oxide orange
- vanilla

Notes

In pairs of hinged doors, the handle is fitted on both doors.
The door covering fabrics are specific for this use and feature a water-repellent surface treatment (Scotchgard).

Hinged door

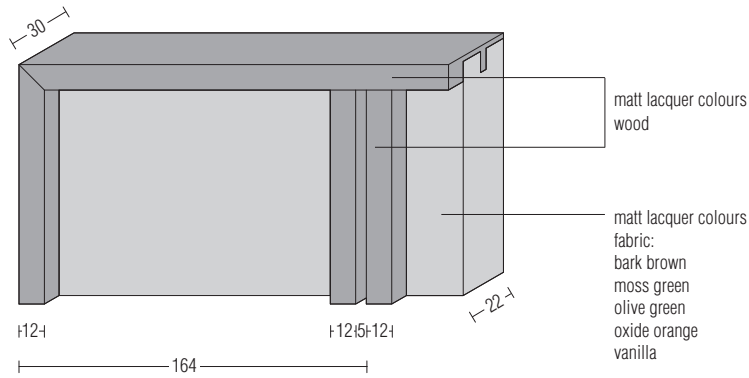

30—
64

External drawer



panel finishes

	matt lacquer colours	fabric	wood	mirror
hinged doors				
width 487 (19 1/8")				
w. 651 (25 5/8")/608 (23 7/8")				
width 815 (32 1/8")				
width 979 (38 1/2")				
width 1307 (51 1/2")				
door for terminal element				

Handle

always in pewter colour finish



external drawer

width 487 (19 1/8")				
width 651 (25 5/8")				
width 815 (32 1/8")				
width 979 (38 1/2")				
width 1307 (51 1/2")				

GLISS
MASTER—
VINCENT
VAN DUYSSEN
2015

GLASS door th 35 design Vincent Van Duysen

Glass door with 180° opening made with a special soft close hinge inserted in the profile and completely hidden in the side (exclusively by Molteni).
A full height handle is designed in the profile.

Integrated lock with coded key

GLASS hinged doors with integrated lock are available, taking into account a surcharge for single door or pair of doors.
As standard, all lockable doors in a wardrobe will have different coded keys.
On the pair of doors, the lock will always be applied to the right door.
The lock is not applicable to hinged doors of the external corner units.

Reductions

GLASS doors can be reduced as shown on p. 32 price list.

Notes

The GLASS doors are available with H 2889 only for widths 487, 815, 979 and for the corner unit 1101x1101.

In the pair of hinged doors, the handle is mounted on both doors in the pair.

The GLASS door can also be installed on the open corner module.

GLASS door

31—
64

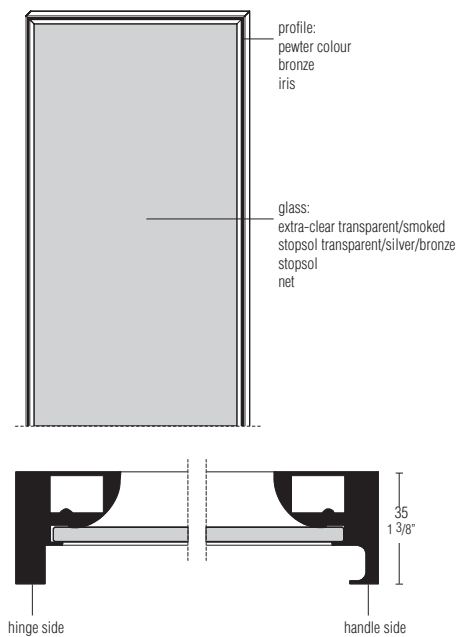

finishes

transparent / smoked glass	stopsol transparent/silver/ bronze glass	stopsol glass	net glass
----------------------------------	--	------------------	--------------

180° Hinged

width 487 (19 1/8")				
w. 651 (25 5/8")/608 (23 7/8")				
width 815 (32 1/8")				
width 979 (38 1/2")				
width 1307 (51 1/2")				
corner unit 1101x1101				
corner unit 1282x1282				

LINEAR door th 25 design Vincent Van Duysen

All the doors applied to the linear modules are equipped with new generation concealed hinges on the side panel, with soft closure.
For use on the 1101x1101 corner element, the glass doors are equipped with pivot hinges (SISTEMA 7), while the wooden doors with traditional 155° hinges.

A handle with lock is available considering a surcharge for single door or a pair (for wood and glass doors).
The lock is not available for corners 1101x1101.

Reductions

The LINEAR doors can be reduced to the millimetre in height and width.

Notes

LINEAR doors cannot be applied to frame or glass sides.
H 2889 hinged doors are available only in W 405/487.

To match the lunar finish, we advise the side exterior finish in matt lacquered argilla and the extension profiles in the same finish as the handle.

LINEAR door wood

matt lacquer colours
lunar

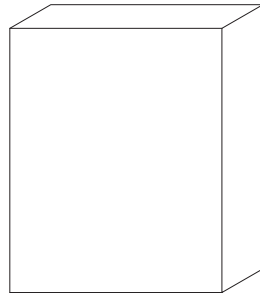

LINEAR door 3D

matt lacquer colours

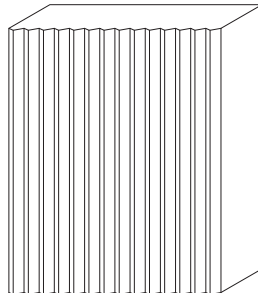

LINEAR door glass

extra-clear transparent glass
smoked glass
transparent stopsol glass
silver stopsol glass
bronze stopsol glass
stopsol glass
3D etched bronze

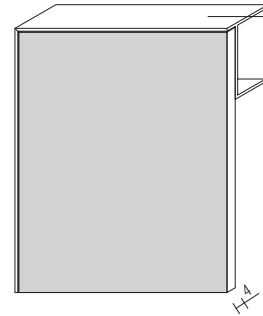

Profile finish:
pewter colour
bronze
iris

32—
64

LINEAR handle

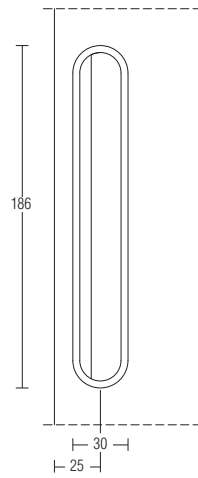

LINEAR handle with lock

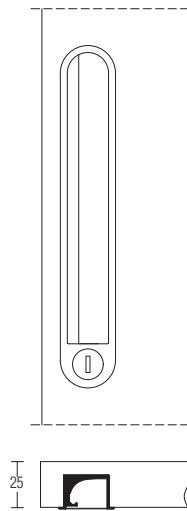

Handle finish:
pewter colour
bronze
iris

finishes

	matt lacquer colours	lunar	3D matt lacquer colours	extra-clear transparent glass	smoked glass	transparent stopsol glass	silver stopsol glass	stopsol bronze glass	stopsol glass	3D etched bronze
hinged doors										
width 487 (19 1/8")										
w. 651 (25 5/8")/608 (23 7/8")										
width 815 (32 1/8")										
width 979 (38 1/2")										
width 1307 (51 1/2")										
corner unit 1101x1101										

SISTEMA 7 wood doors th 35 design Vincent Van Duysen

Doors characterised by increased thickness, made in structural honeycombed panels that make the surface perfectly flat. Patented folding system. All doors are fitted with soft-closing mechanism.

Notes

Doors are not available with H 2889.

SISTEMA 7 wood doors

matt lacquer colours
glossy lacquer colours
wood

90° / 180° Folding

180° Hinged

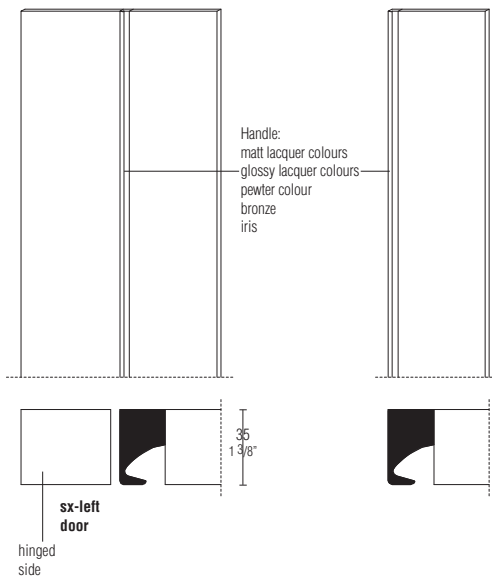

finishes

	matt lacquer colours	glossy lacquer colours	vertical grain wood
180° Folding			
width 815 (32 1/8")			
width 979 (38 1/2")			
corner unit 1101x1101			
90° Folding			
width 815 (32 1/8")			
width 979 (38 1/2")			
180° Hinged			
width 405 (16")			
width 487 (19 1/8")			
w. 651 (25 5/8")/608 (23 7/8")			
width 815 (32 1/8")			
width 979 (38 1/2")			
width 1307 (51 1/2")			
corner unit 1101x1101			

SISTEMA 7 glass doors th 35 design Vincent Van Duysen

Glass door with aluminium outer profile, th 35 mm.
Patented folding mechanism.
All doors are equipped with soft-closing system.

Notes

Doors are not available with H 2889.

Integrated lock with coded key

Hinged doors with 180° opening and 90° / 180° folding doors are available with integrated lock, considering a surcharge for single door or pair of doors.
As standard, all lockable doors in a wardrobe will have different coded keys.
On the pair of hinged doors, the lock will always be applied to the right door.
On the 90° / 180° folding doors it will be applied to the upright opposite to the handle (see section).
The lock is not applicable to hinged doors of the external corner units.

SISTEMA 7 glass doors

90° / 180° Folding

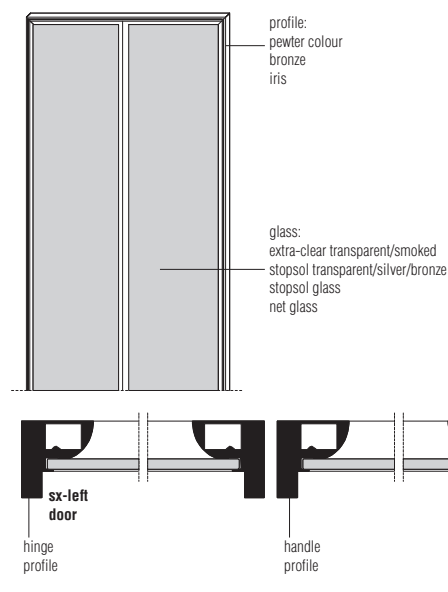

180° Hinged

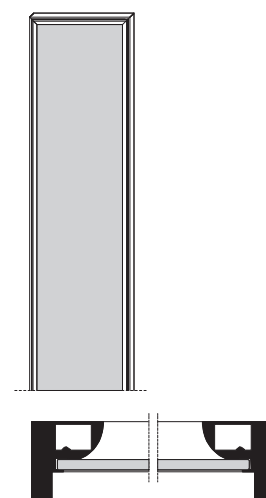

finishes

	transparent/ smoked glass	stopsol transparent/silver/ bronze glass	stopsol glass	net glass
180° Folding				
width 815 (32 1/8")				
width 979 (38 1/2")				
corner unit 1101x1101				
90° Folding				
width 815 (32 1/8")				
width 979 (38 1/2")				
180° Hinged				
width 405 (16")				
width 487 (19 1/8")				
w. 651 (25 5/8")/608 (23 7/8")				
width 815 (32 1/8")				
width 979 (38 1/2")				
width 1307 (51 1/2")				
corner unit 1101x1101				

GLISS
MASTER—
VINCENT
VAN DUYSSEN
2015

SISTEMA 7 doors th 35

With SISTEMA 7 it is possible to create passageway solutions with doors fastened to Gliss Master wardrobe structures.
This type of solution requires the insertion of a lid between the sides of the wardrobes.
It can be opened thanks to a 180° folding door in wood or glass.

Reductions

180° folding doors can be reduced in height only.

Notes

Doors are not available with H 2889.

35—
64

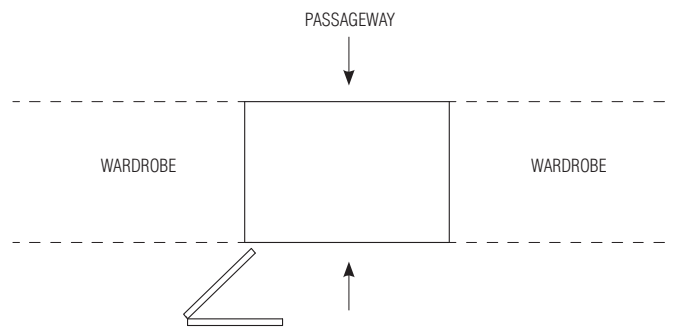
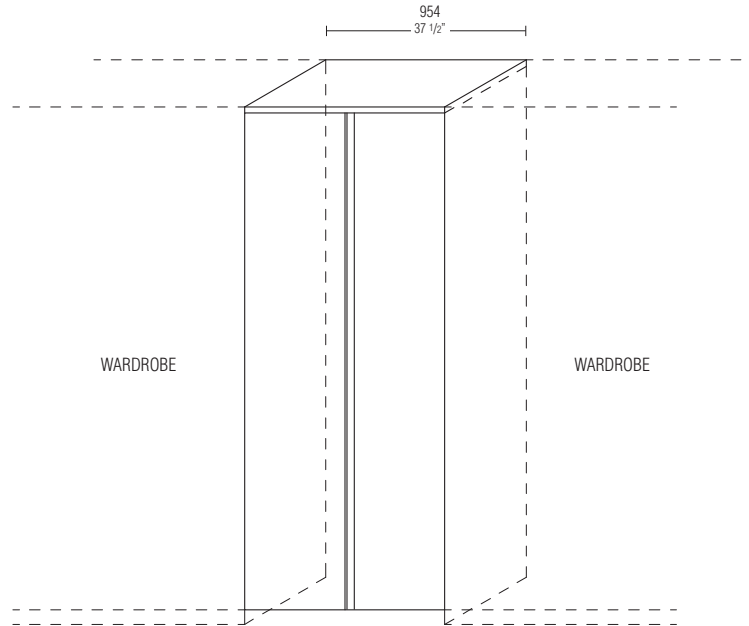

SPECIAL ELEMENTS

Column with open compartment

- Can be inserted only in wardrobes without doors or with hinged doors.
- Central partitions and/or lateral pieces close the column and cannot be frame or glass.
- The open compartment is always in matt lacquered colours.
- Doors are always without handles because they protrude with respect to the structure.
- Drawers are fitted with the "E" handle of the START door.
- Front finish: melamine front, matt lacquered colours, glossy lacquered colours and wood.

* **The price does not include the central partitions or side panels, nor the internal shelves.**

Reductions are allowed only in height, and costs of cutting the structure and doors are applied. Open compartment and lower part cannot be reduced.

Wire passage **EPA1 Ø 60** chrome on request on back.

Notes

The back of the open compartment cannot hold a mounted TV.

Reductions

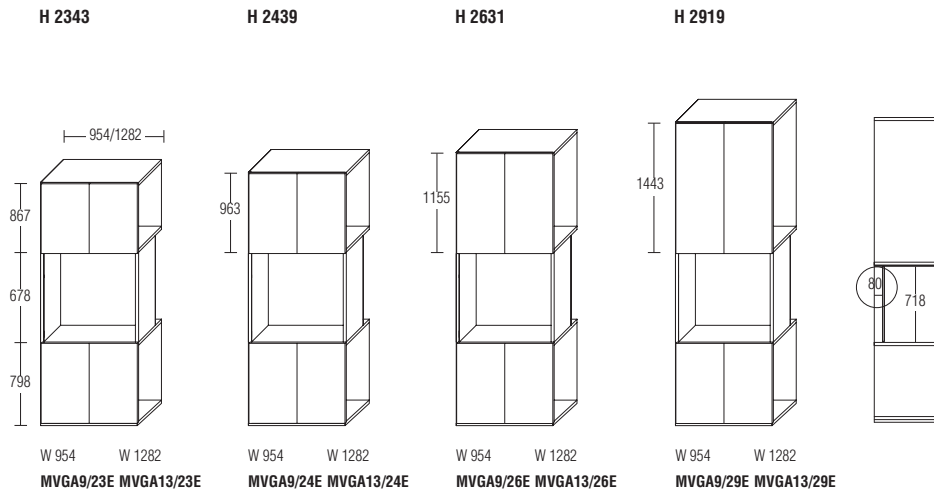
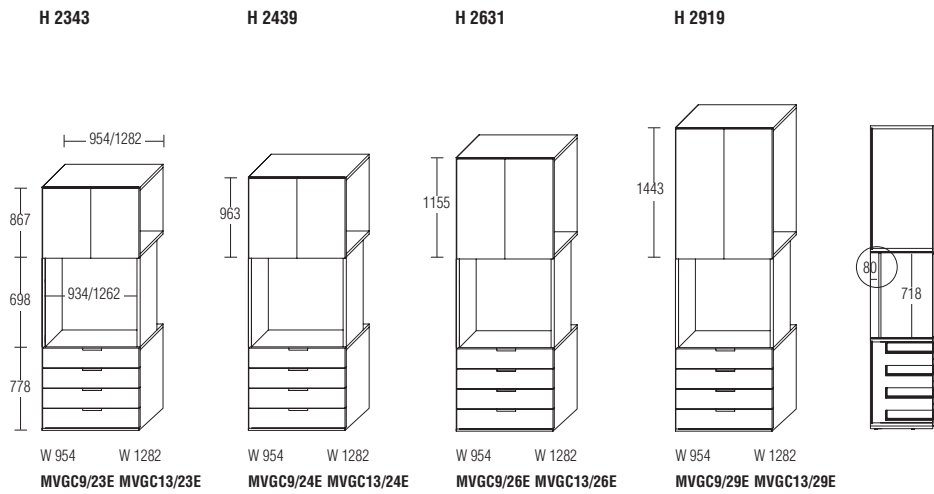

SPECIAL ELEMENTS

Column with external drawers

- Can be inserted only in wardrobes with hinged doors.
- Central partitions and/or lateral pieces close the column and cannot be frame or glass.
- Pairs of doors always have only one handle mounted on the right door.
- Drawers are fitted with the "E" handle of the START door.
- Front finish: melamine front, matt lacquered colours, glossy lacquered colours and wood.

Reductions

Reductions are allowed only in height, and costs of cutting the structure and doors are applied.

* The price does not include the central partitions or side panels, nor the internal shelves.

**Doors with
type "E" handle**

H 2343

H 2439

H 2631

H 2919

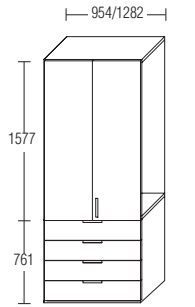

W 954 W 1282
MCE9/23E MCE13/23E

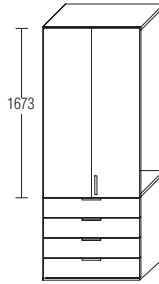

W 954 W 1282
MCE9/24E MCE13/24E

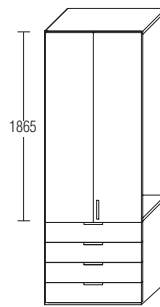

W 954 W 1282
MCE9/26E MCE13/26E

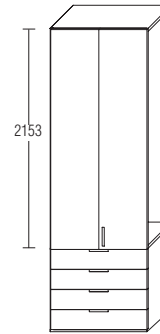

W 954 W 1282
MCE9/29E MCE13/29E

**Doors with
"A FILO" handle**

H 2343

H 2439

H 2631

H 2919

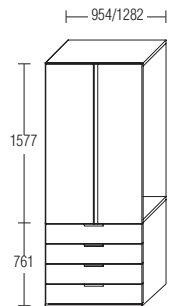

W 954 W 1282
MCE9/23F MCE13/23F

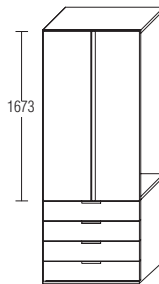

W 954 W 1282
MCE9/24F MCE13/24F

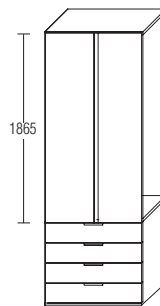

W 954 W 1282
MCE9/26F MCE13/26F

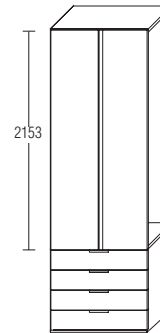

W 954 W 1282
MCE9/29F MCE13/29F

GLISS
MASTER—
VINCENT
VAN DUYSSEN
2015

BEAUTÈ design Rodolfo Dordoni

finishes		eucalyptus / graphite oak	pewter colour / bronze / iris	Eco Skin	melamine structure
components					
base / top	top				
	trim				
upper shelf and back mirror					
back panel					
display shelf	top				
	profile				
drawer unit structure					
drawer unit front	panel				
	profile				
internal drawers					
drawer unit top					
internal tray	structure				
	bottom				
end panel					
central panel	inside				
	outside				

Eco Skin
grey
mink
hemp
ivory
dark brown
earth
arctic
taupe

BEAUTÉ design Rodolfo Dordoni

Vanity use example

Side

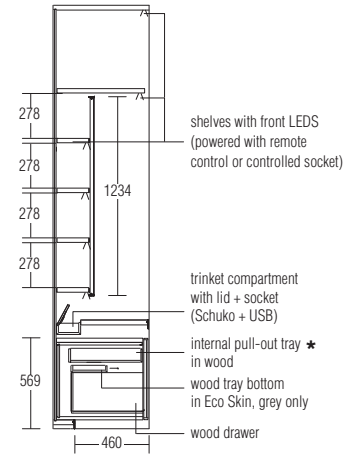
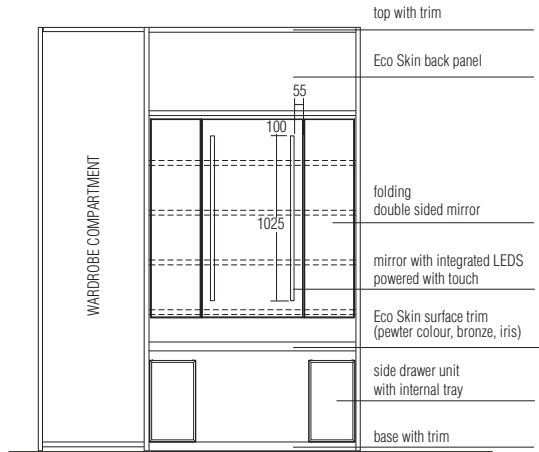

* Insertion is possible of a tray leather (A) or two (B) (see price list page 178)

39—
64

Central

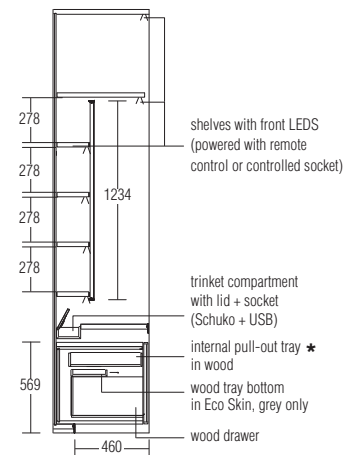
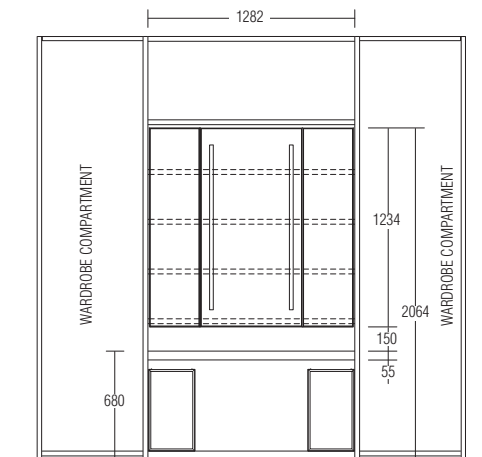

* Insertion is possible of a tray leather (A) or two (B) (see price list page 178)

Types of panels

Central panel - used if the adjacent compartment has a door

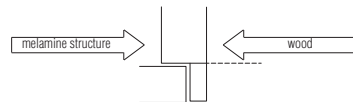

Central or end panel - used with open adjacent compartments with front profile panels or frame/glass panels

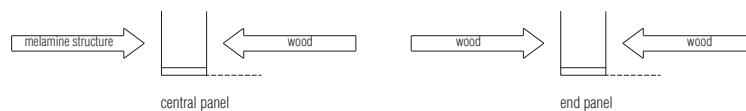

Central panel - used with open adjacent compartments with melamine structure panels

End panel - used whenever the adjacent compartments have a door or with open melamine structure panels

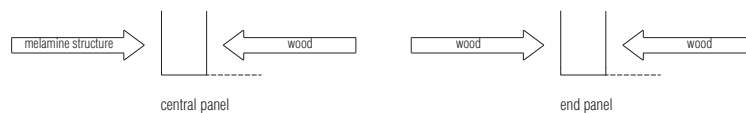

VANITY

Gliss Master expands the design proposal with the elegant Vanity, created using components derived from the 505 UP series.

The matt and glossy lacquered structure in the colours of the range, matches the Eco Skin display shelf and the deluxe compartment, allowing for a perfect balance of design and materials.

Vanity finishes		matt lacquer colours	glossy lacquer colours	pewter colour/ bronze/ iris	bronze mirror	Eco Skin
components						
structure						
back						
small partition panels th.12						
deluxe compartment	back					
	shelf					
projecting top H 72	top					
	trims					
	wire passage					

colours	Matt lacquer	Glossy lacquer	Eco Skin
	BC chalk white	BC chalk white	grey
	PE pearl	PE pearl	mink
	DN dune	DN dune	hemp
	PL platinum	PL platinum	ivory
	NE black	NE black	dark brown
	AT anthracite	AT anthracite	earth
	SE mustard	SE mustard	arctic
	SI silica	SI silica	taupe
	DO dolomite grey	DO dolomite grey	
	AL clay	AL clay	
	MK moka	MK moka	
	CZ light blue grey	CZ light blue grey	
	SA sand	SA sand	
	RU ruby	RU ruby	
	PX pewter colour	PX pewter colour	
	RX copper	RX copper	
	TO dove grey	TO dove grey	
	PR petroleum blue	PR petroleum blue	
	BG burgundy	BG burgundy	
	LS london sky	LS london sky	
	SU stardust	SU stardust	
	ML moonlight	ML moonlight	
	SP spice	SP spice	
	PG pine green	PG pine green	
	AW almond white	AW almond white	

GLISS
MASTER—
VINCENT
VAN DUYSSEN
2015

VANITY

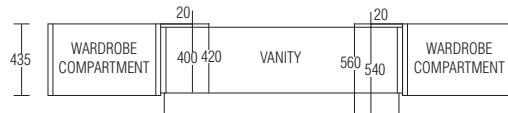
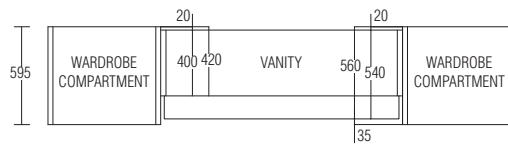
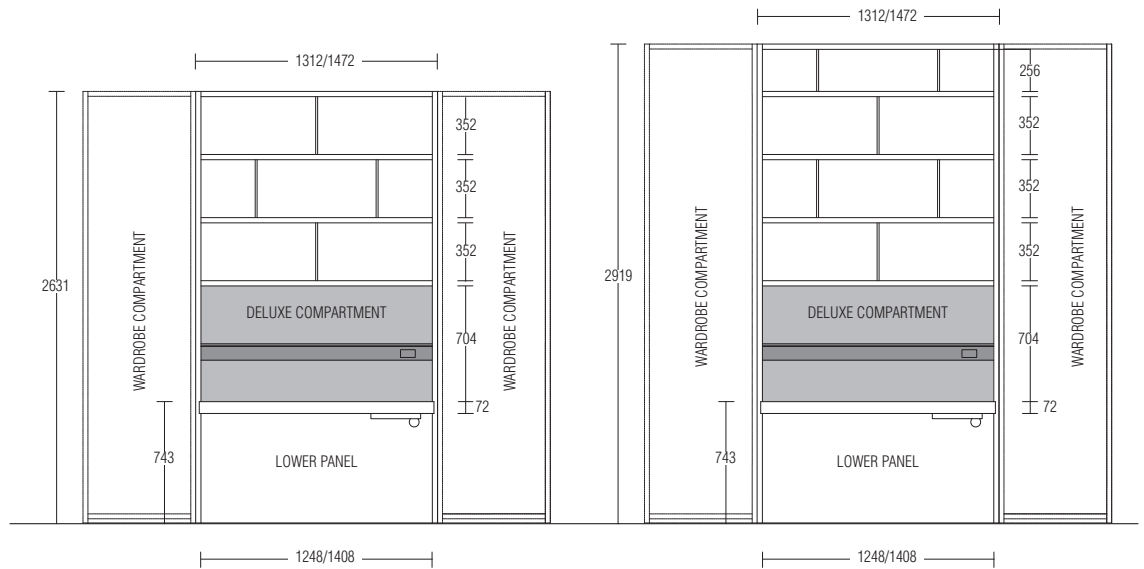
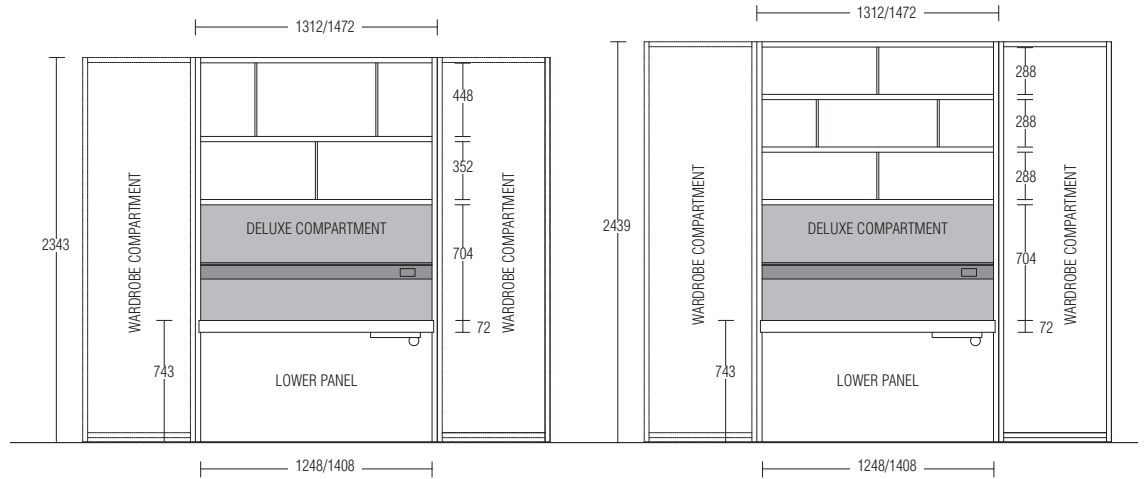

FILLERS AND OPENING SIDE TRIMS

Horizontal filler

The filler is supplied in two parts, one part to be fixed to the ceiling to which the other will be hooked on (see diagram below).

The distance of the filler from the door is the client's decision.

In the cartapaglia finish, the grain direction is always vertical.

In the wood, lunar, glaze, 3D lacquer finish, the grain is always horizontal.

Vertical filler

The vertical filler can be placed flush with the structure or the door.

This detail must be specified in the order to prepare the side panel (see example).

If this detail is not specified when placing the order, the filler will automatically be placed flush with the structure and the side panel will have the extension profile.

Opening fillers

Can be made with START and "A FILO" door. For handles, consider surcharge.

Always have the 155° hinges.

Are the same height as the other doors in the composition.

Have a closing strip on their lower part.

In the wood finish, the grain direction is always vertical.

Horizontal filler side sections

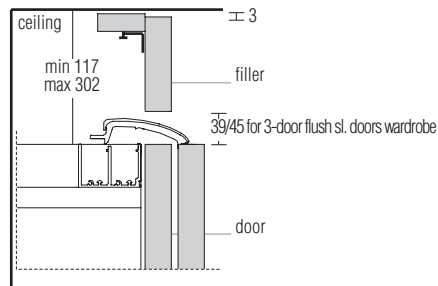
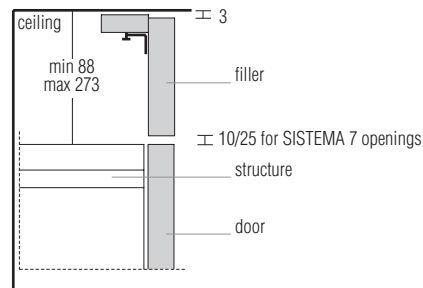

Vertical filler horizontal sections

Flush with structure

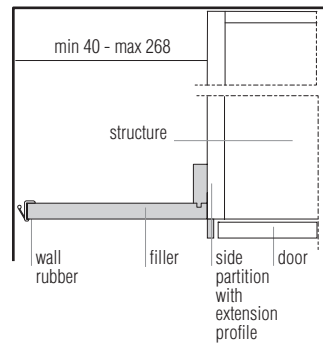

Flush with door

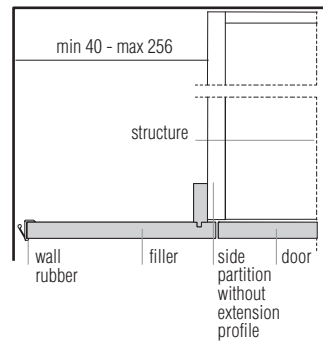

Set back

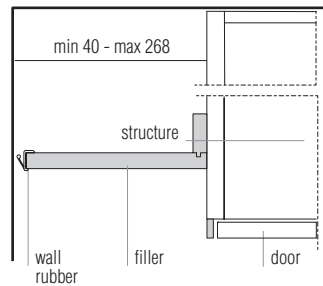

Opening filler horizontal sections

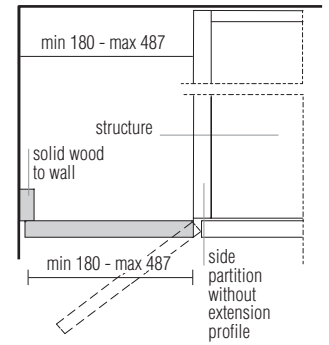

LIGHTING SYSTEM

Lighting bars with front LEDs

Internal compartments of Gliss Master wardrobes can be equipped with front LED lighting. The lighting bar can be applied to lids or to wooden, transparent glass and Eco Skin shelves, wood and glass shoe rack shelves. Using the electrified wire strip installed on the side (wood, frame or glass), the shelf can be moved. For each compartment length, we have made specific lighting bars with wiring compliant with European safety standards.

A wire strip is not needed if the compartment only has lighting on the top piece.
Lighting bars can be reduced with a surcharge for the shelf cutting.

Horizontal and vertical LEDs cannot be used for the same composition.

Notes

When placing the order, the customer must indicate how many shelves with lighting bars are required.

For assembly: a lighting system on wardrobe with hinged doors requires a minimum extra height of 5 cm (2").

The height can be reduced to 15 mm by inspection on top cod. PAISPC01 (see page 33 price list).

Individual wire strip is always installed on the left side panel of the compartment, with the exception of corner units for walk-in wardrobes and of the compartment next to the corner unit.

When ordering, indicate compartments with wire strip.

The electrified wire strip is mandatory for wardrobes with wooden sides and glass back.

lighting bars 3000 K	W 380 2,5 watt	W 462 3 watt	W 626 4 watt	W 790 5 watt	W 954 6 watt	W 1282 8 watt	open corner element 8 watt	external corner unit 7 watt
	EBI2C	EBI4C	EBI6C	EBI8C	EBI9C	EBI13C	EBA13C	EBB6C

components per system

(see the diagram for component use and to calculate system cost)

power supply unit 100W

(see the diagram for component use and to calculate system cost)

sensor

(see the diagram for component use and to calculate system cost)

electrified wire strip

(see the diagram for component use and to calculate system cost)

connector (1 for 4 power supply units)

(see the diagram for component use and to calculate system cost)

radio control kit with brightness setting (1 per power supply unit)

(see the diagram for component use and to calculate system cost)

power supply unit block 100W with watertight box for wardrobe with glass top

(see the diagram for component use and to calculate system cost)

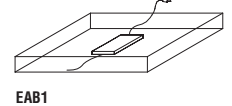
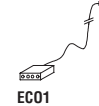
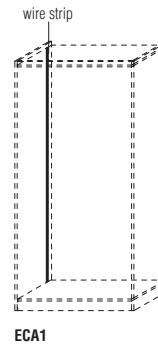
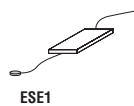
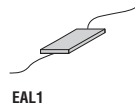

position of bar and wire strip on wooden partitions

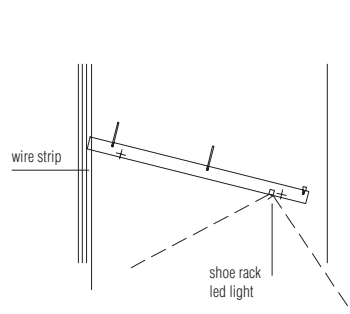
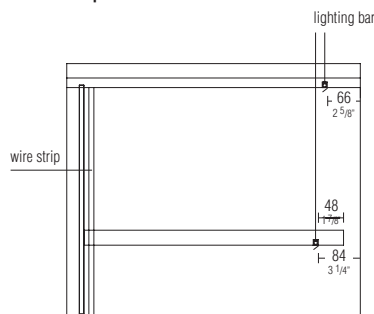

position of bar and wire strip on glass partitions

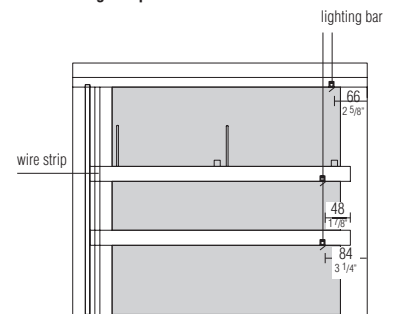

LIGHTING SYSTEM

System construction diagram

A composition (wardrobe) can be equipped with more than one system and more than one power supply unit. The system with sensor must be autonomous from the system with remote controlled electrical socket.

system type with sensors or remote control

system with sensor or remote control + channel

system with sensor or remote control (not for use with glass backs)

suggested for wardrobes with doors and bars positioned only on the top piece

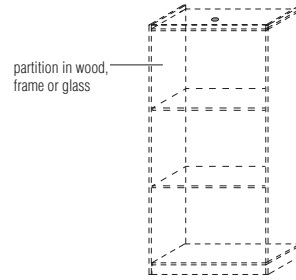
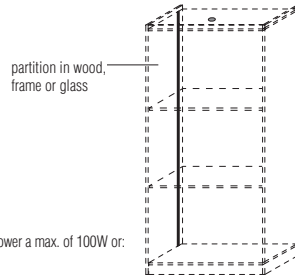

★ each power supply unit can power a max. of 100W or:
max 6 sensors
max 6 channels

power supply unit *	●	●
connector (4 power supply units max.)	●	●
wire strips on lateral pieces (1 per compartment)	●	●
sensor (1 per compartment) (optional)	●	●
radio remote control (1 per power supply unit) (optional)	●	●

DALI kit (for DOMOTICA)

n. 1 for each power supply unit
cannot be used with
radio remote control

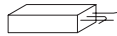

EKDA1

SMART INTERNAL FITTINGS

Clothes rails

For use only with wood shelves.
Black finish.
Supplementary cost for cut in width.

Drawer units

Floor-standing or wall-mounted drawer units with drawers H 190 mm equipped with handles in black finish.

2, 3, and 4 drawer versions cannot be modified.

The drawer units are not stackable. In the event that requirements are different, use standard modular drawer units.

The width of the drawer units can be reduced for a surcharge:

Clothes rails



W 298	W 380	W 462	W 626	corner external	W 790	W 954	W 1282
PP/03	PP/02	PP/04	PP/06	PPB/06	PP/08	PP/09	PP/13

Clothes rail for corner element with doors



PPA/06

45—
64

Clothes rails

Clothes rails for D 435

To mount on wooden shelves or top only with hinged door
1 piece on compartment W 626 / 790
2 pieces on compartment W 954 / 1282

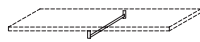

PPQ/04

Clothes rails for open corner element

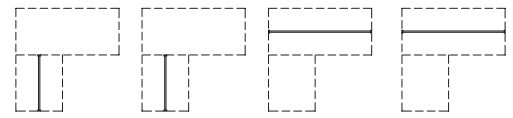

W 543
PPA/05

W 723
PPA/07

W 1081
PPA/11

W 1262
PPA/13

Drawer units floor standing or suspended

H 420

2 wooden drawers H 190



W 462
CNT4/04PB

W 626
CNT6/04PB

W 790
CNT8/04PB

W 954
CNT9/04PB

W 1282
CNT13/04PB

Drawer units floor standing or suspended

H 612

3 wooden drawers H 190



W 462
CNT4/06PA

W 626
CNT6/06PA

W 790
CNT8/06PA

W 954
CNT9/06PA

W 1282
CNT13/06PA

Drawer units floor standing or suspended

H 804

4 wooden drawers H 190



W 462
CNT4/08PA

W 626
CNT6/08PA

W 790
CNT8/08PA

W 954
CNT9/08PA

W 1282
CNT13/08PA

"Smart" handle

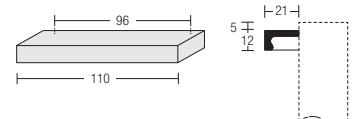

SMART INTERNAL FITTINGS

Vertical Internal LED Lighting

The vertical illumination can only be used on central or lateral wooden side panels.
Cannot be used with GLASS, SISTEMA 7 and LINEAR doors.
Horizontal and vertical LEDs cannot be used in the same composition.
LED bars can be reduced without a supplementary charge.

In the case of hinged doors with a lighting system, a minimum space measuring 5 cm in height is required. The height can be reduced to 15 mm by inspection on top cod. **PAISPC01**.

Only 220V - Certifications C E

Vertical LED bars

H 2343
16 watt

H 2439
17 watt

H 2631
18 watt

H 2919
20 watt



EVBA23



EVBA24



EVBA26



EVBA29

Side section with position

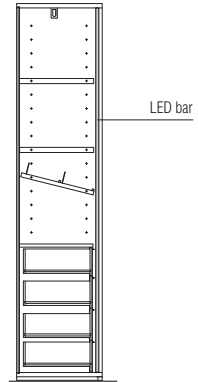

46—
64

Specific components for systems with vertical LEDs

Power supply units
50 watt, 75 watt, 100 watt

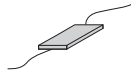

EVAL050

EVAL075

EVAL100

Sensor



EVSE1

Connector
(1 for 4 power supply units)



EVCO1

Remote control with dimmer
1 per power supply unit



EVRA1

Diagram of LED lighting system

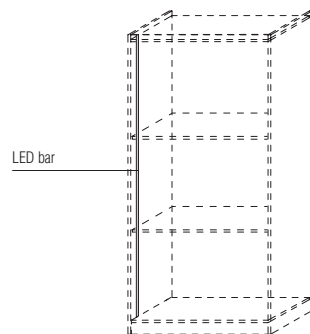

Components

- LED bar, 1 or 2 per compartment
- power supply unit, 1 or 2 per wardrobe depending on total wattage
- connector, 1 per wardrobe
- optional remote control, in the absence of a controlled socket
- optional sensor, in the absence of a controlled socket

INTERNAL ACCESSORIES

Aircub is an air purifier and aromadiffuser that eliminates up to 95% of the harmful agents inside wardrobe through a process of ionisation and ozonation. Aircub can be managed easily from your smartphone with a dedicated app. Aircub can be installed on the back panel of each compartment by using the specific multi-socket connector. Aircub has a single plug.

Up to 3 Aircubs per wardrobe can be installed using the specific multi-socket connector. Information about Aircub is available on the website <https://shop.check-up.it> in the projects section.

Aircub - air purifier
W 270 D 28 H 120
W 10 5/8" D 1 1/8" H 4 3/4"
(cable length L3m)

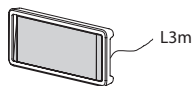

EAC1

product advantages

- improves air quality
 - reduces bacteria that cause foul odours
 - prevents mould and mites from forming
 - dispenses fragrance
 - does not have filters that require maintenance or changes
 - includes n.1 fragrance pod
- Scented wafers can be ordered online:
<https://shop.check-up.it/>

multi-socket connector
cable length 3m
W 250 D 60 H 40
W 9 7/8" D 2 3/8" H 1 5/8"

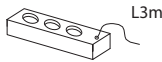

EAC2

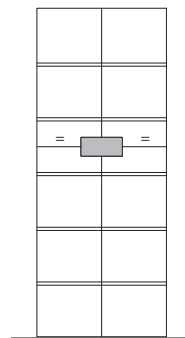
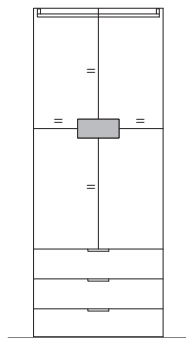

For correct function it is advisable to position the Aircub at the centre of the compartment

INTERNAL FITTINGS

Internal fittings
with wooden sides

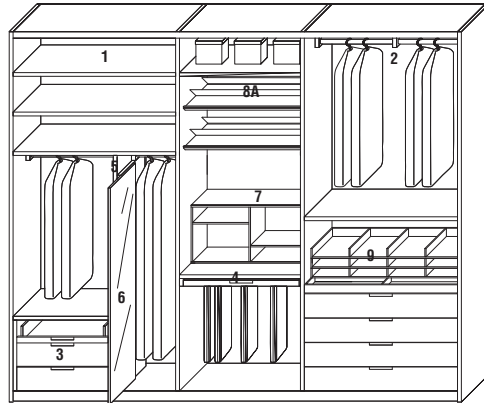

Internal fittings
with frame or glass sides

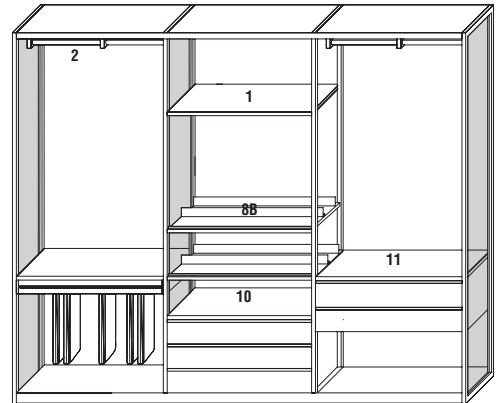

- 1** Shelf th 30 mm (wood, glass, Eco Skin)
- 2** Clothes rail
- 3** Modular drawer unit only for wooden sides and backs
- 4** Trouser holder
- 5** Central divider piece th mm 30 only for compart. with wooden sides and backs
- 6** Swivel pull-out mirror only for compart. with wooden sides and backs
- 7** Sweater and shirt holder module only for wooden sides and back panels
- 8A** Inclined shoe rack shelf only for wooden sides and backs
- 8B** Horizontal shoe rack shelf only for frame sides, glass sides or glass back
- 9** Pull-out shirt holder only for wooden sides and backs
- 10** Floor standing drawer unit only for compart. with frame or glass sides
- 11** Suspended drawer unit only for compart. with frame or glass sides

Section of internal fittings

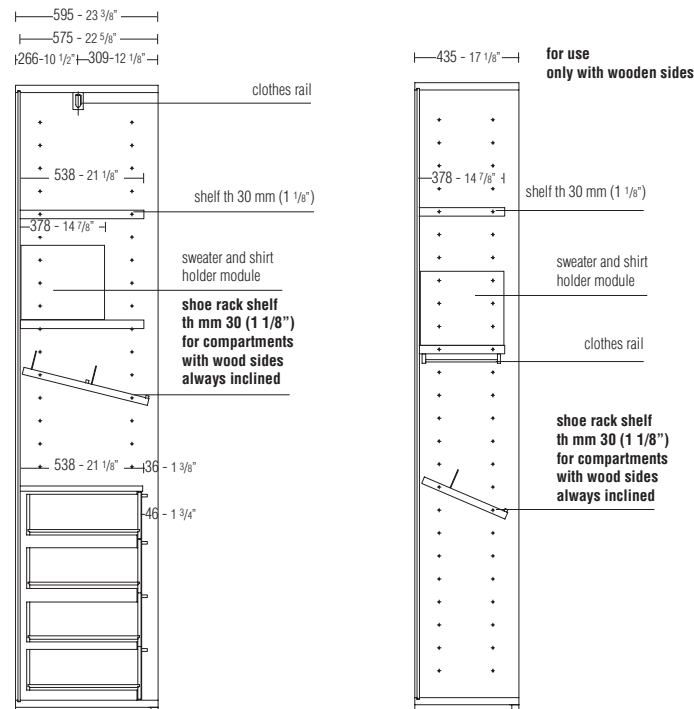

SOFT LINE INTERNAL FITTINGS

- ▶ The SOFT LINE equipment can be used in units with frame, glass and wooden side panels and with all types of backs.
- ▶ In case of application on the glass/frame side panels, the special metal profiles PST/PSV must be used. These are not included in the price of the trays.
- ▶ The pull-out frames of the SOFT LINE equipment cannot be combined with modular drawer units.
- ▶ **No reductions of any kind are possible.**

Notes

- The SOFT LINE equipment should not be used:
- in corner units
 - in units close to corner elements in wardrobes with doors
 - in units closed by overlapping sliding doors.

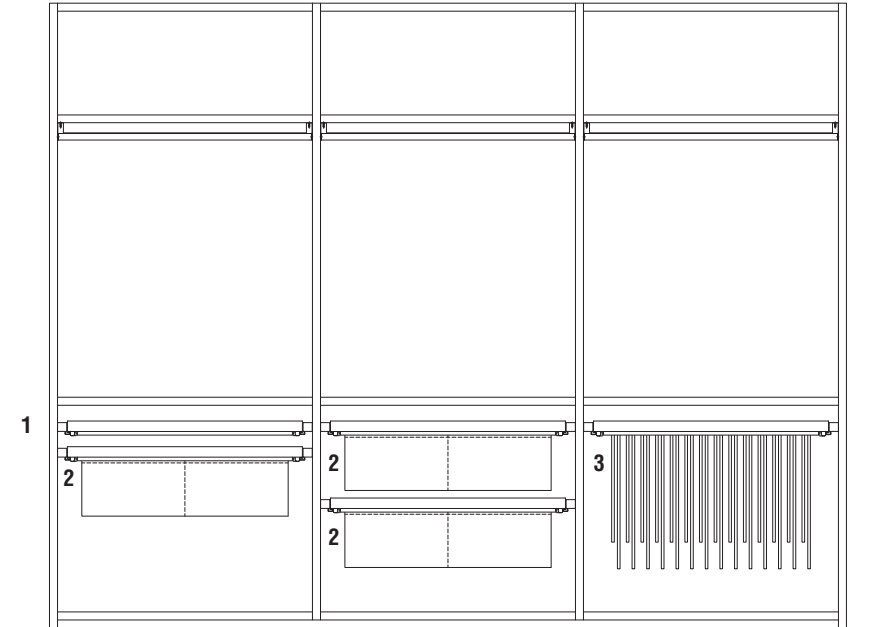

- 1 Pull-out frame with Eco Skin bottom / with Eco Skin bottom and internal grid
- 2 Pull-out frame with Eco Skin sack
- 3 Trouser holder pull-out frame

The positioning of the pull-out frames is always at 96 mm intervals (see example)

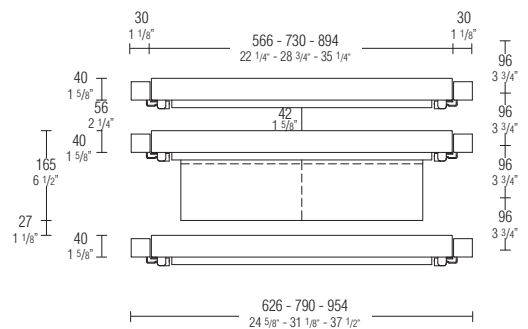
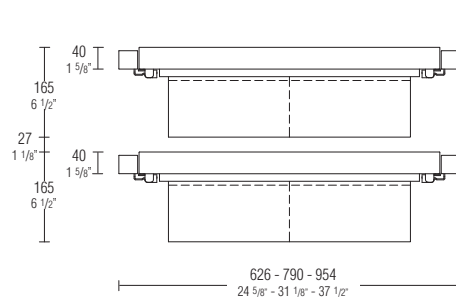

SOFT LINE INTERNAL FITTINGS

Finishes of pull-out frame, internal grid and trouser holder bars

bronze
pewter colour
iris

Finishes of bottoms and Eco Skin sack

grey
mink
hemp
ivory
dark brown
earth
arctic
taupe

Pull-out frame with Eco Skin bottom

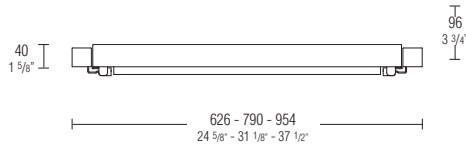

50—
64

Pull-out frame with Eco Skin bottom and internal grid

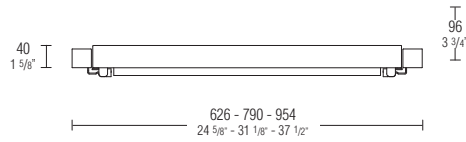

Internal aluminium grid th 5 mm

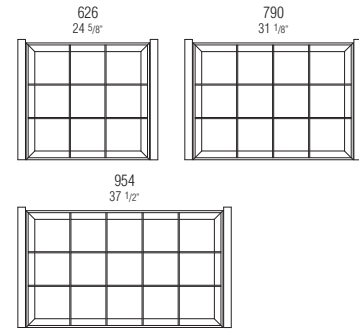

Trouser holder pull-out frame

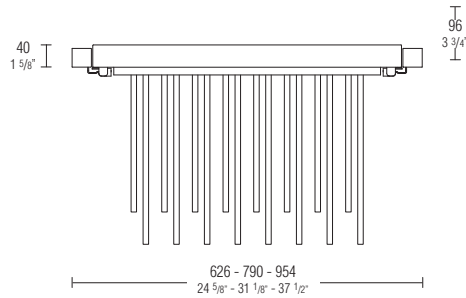

W 626 : max **8** bars
W 790 : max **11** bars
W 954 : max **14** bars

Pull-out frame with Eco Skin sack

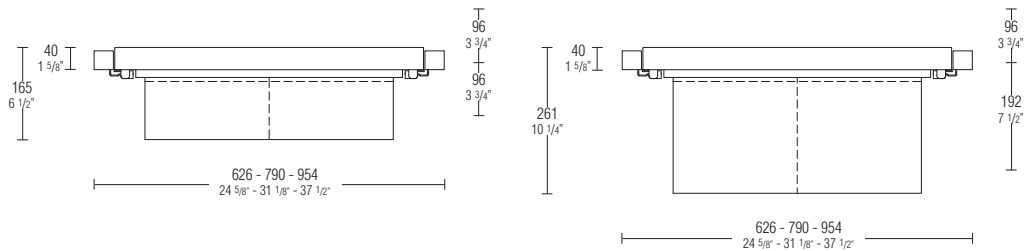

INTERNAL FITTINGS

wood shelves - top shelves (only D 538)

D 538 th 30
D 378 th 30

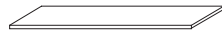

W 298	W 380	W 462	W 626	W 790	W 954	W 1282
RI/3	RI/2	RI/4	RI/6	RI/8	RI/9	RI/13

shelf for external corner unit

th 30

559x559
RIB/6

shelf for open corner element

th 30

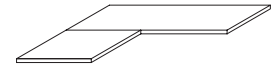

1081x1081	1262x1262
RIA/11	RIA/13

glass shelves can be fitted with front LED light bars and comply with the wiring standards specified on pages 142/143 price list

transparent glass shelves

D 538 th 30
D 378 th 30



W 380	W 462	W 626	W 790	W 954	W 1282
RV/2	RV/4	RV/6	RV/8	RV/9	RV/13

not for use in compartments adjacent to the corner element in wardrobes with doors

shelf for external corner unit

th 30

559x559
RVB/6

Eco Skin shelves can be fitted with front LED light bars and comply with the wiring standards specified on pages 142/143 price list

Eco Skin shelves - shelves with Eco Skin cover (only D 538)

D 538 th 30
D 378 th 30

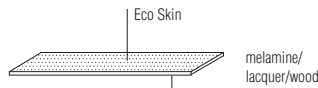

W 298	W 380	W 462	W 626	W 790	W 954	W 1282
RE/3	RE/2	RE/4	RE/6	RE/8	RE/9	RE/13

shelf for external corner unit

th 30

559x559
REB/6

Eco Skin shelf for open corner element

th 30

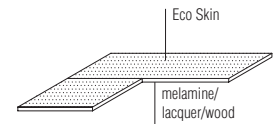

1081x1081	1262x1262
REA/11	REA/13

When ordering, specify the finish Eco Skin and profile

terminal element shelf

W 462 D 365/533 th 30



RIT/4

corner shelf

W 622 D 622 th 30

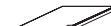

RIA/6

metal profile

for shelves beside the corner but not adjacent to shelves RIA/6

PSA

mandatory to cover drawer units W 1282 with single drawer

reinforced shelves

D 538 th 30



top
W 1282
RR/13

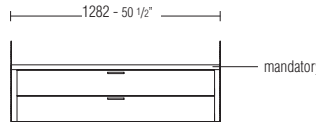

reinforced Eco Skin shelves

pewter colour, bronze or iris front profile
D 538 th 30

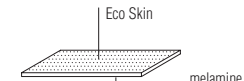

top
W 1282
RRE/13

Shoe rack shelves

Shoe rack shelves can be used with wood sides and with frame or glass sides. When inserted between wood sides, this part will always be inclined (example 1). When there are frame or glass sides, this part will always be horizontal (example 2).

Notes

To hook to the frame or glass sides, add the price of the relative metal profiles.

example 1

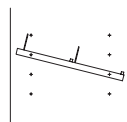

shoe rack shelves

D 538 th 30



W 462	W 626	W 790	W 954	W 1282
RSP/4	RSP/6	RSP/8	RSP/9	RSP/13

example 2

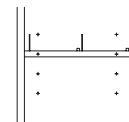

example 1

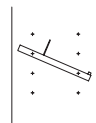

shoe rack shelves

D 368 th 30

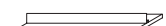

W 462	W 626	W 790	W 954	W 1282
RQP/4	RQP/6	RQP/8	RQP/9	RQP/13

metal profile for attaching shelves to frame side



PST

metal profile for attaching shelves to glass side



PSV

metal profile for attaching shelves with LEDs to frame side (always on the left, except in corner shelves)



PSE

INTERNAL FITTINGS

clothes rails

	W 298	W 380	W 462	W 626	for external corner unit	W 790	W 954	W 1282
	P0/3	P0/2	P0/4	P0/6	P0B/6	P0/8	P0/9	P0/13

clothes rail for
corner compartment
with doors

	P0A/6
---	-------

clothes rail
for D 435

to mount on wood shelves or
top only with hinged doors

nr. 1 piece on compartment W 626/790
nr. 2 pieces on compartment W 954/1282

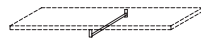

P0Q/4

clothes rails
for open corner
compartment

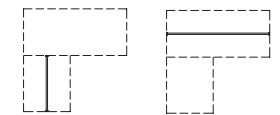

W 543	W 1081
W 723	W 1262
P0A/5	P0A/11
P0A/7	P0A/13

pull-out coat hanger rail

for melamine shelf (without profile) th 30



OP7

hanger
W 450

beech stained grey
(package of 10 pieces)



OP10

hanger with clips
W 450

beech stained grey
(package of 3 pieces)

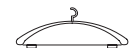

OP11

Maximum
load-bearing capacity
10 kg

pull-down hanger

H mm 1040
for compart. W 626

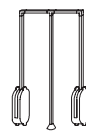

SER/6

for compart. W 790

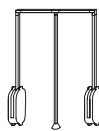

SER/8

for compart. W 954

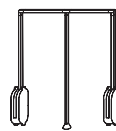

SER/9

for compart. W 1282

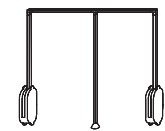

SER/13

When ordering, specify
the finish of the front profile:
pewter colour, bronze or iris

floor standing
central divider pieces

D 538 th 30

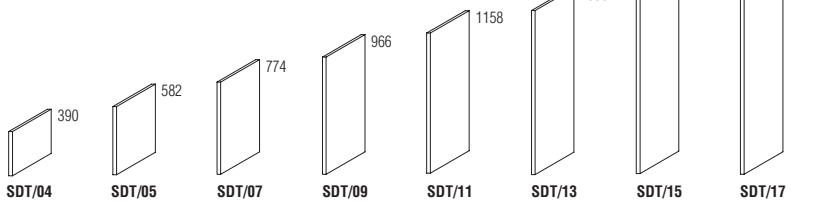

Glass shoe rack shelves

Shoe rack shelves in glass can be used only with wood sides.

Notes

No reductions of any kind are possible.

glass shoe rack shelves

D 520 th 30

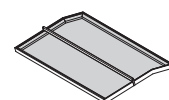
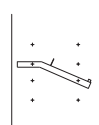

W 790	W 954	W 1282
RSW/8	RSW/9	RSW/13

GLISS
MASTER—
VINCENT
VAN DUYSSEN
2015

GLASS LID FOR CHEST OF DRAWERS

To be used only in compartments with wooden sides

Modular chests of drawers can be made with a transparent glass lid in the module widths 790/954/1282.

It is mandatory that the first drawer be H 190 in wood (special measure).

Drawer dividers cannot be inserted in the first drawer.

The top can be fitted with a LED lighting bar, but it cannot be connected to the cable holder.

The connection to the power cord has to pass behind the back panel.

Eco Skin bottoms in grey can be inserted.

Lid profiles

bronze
pewter colour
iris



W 790
CSV/08

W 954
CSV/09

W 1282
CSV/13

53—
64

Example of use

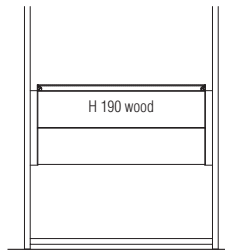

canvas-covered boxes
with Molteni logo

W 500 D 400 H 150
(package of 2 pieces)

W 500 D 400 H 300
(package of 2 pieces)



CES1



CES2

INTERNAL FITTINGS

Pull-out shirt holder only for use in compartments with wooden sides

These units can be positioned on the floor-standing drawer units or suspended over a drawer H 190 of the same dimensions as the shirt unit (see ex. 1).

Notes

Do not use for compartments with glass back.

Finishes

The tray set on top of the shelf is always finished in melamine in the same finish as the structure with Eco Skin bottom grey finish.
The shirt holder grid is always dolomite lacquered.

example

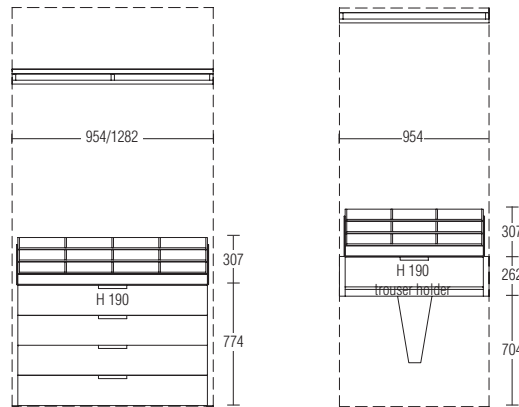

When ordering, specify the finishes of the trays set on shelves and the shirt holder grid

for compartment
W 954
including resting shelf

for compartment
W 1282
including resting shelf

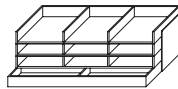

BPC9/03/1

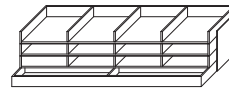

BPC13/03/1

Internal fittings - sweater and shirt holder module

Fixed elements to be used resting on shelves or chests of drawers.

In the compartments indicated with ■ it is possible to insert the Swisskubik Masterbox automatic watch winding devices (rotors).

sweater and shirt holder module

W 625 D 378 H 354

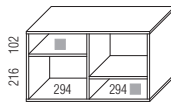

BG06/03/1

W 789 D 378 H 354

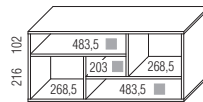

BG08/03/1

sweater and shirt holder module

W 953 D 378 H 354

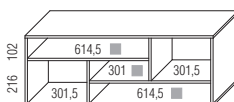

BG09/03/1

W 1281 D 378 H 354

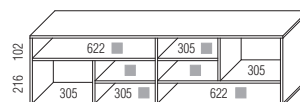

BG013/03/1

watch winder Masterbox of Swisskubik

W 100 D 100 H 100



BGC01

INTERNAL FITTINGS

Procedure for using the swivel pull-out mirror

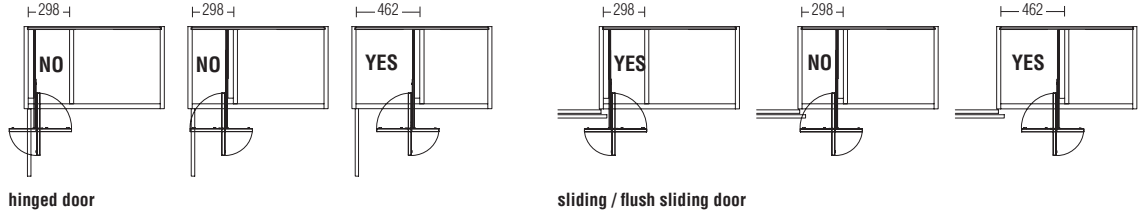

mirror
applied to inside of
hinged door
W 315 H 1600 th 4

swivel pull-out mirror
to be applied onto the side,
partition or central divider pieces
D 555 H 1443 th 90

55—
64



SPECH

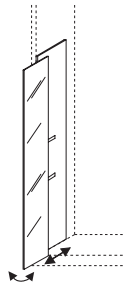

SPECS/17

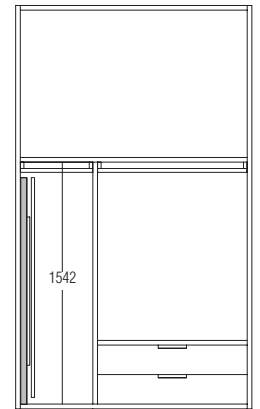
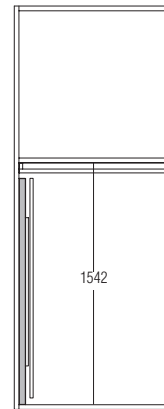
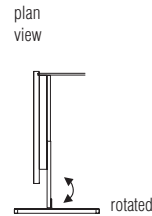

CAVE handle

Internal fittings - modular drawers and trays

Notes

The parts of this internal fittings are produced with width and height dimensions corresponding to the modular compartments. This makes it possible to organise the internal spaces in a number of ways. To correctly and quickly determine the internal fittings, some of the possible compositions are in the following pages.

When ordering, specify the handle finish as pewter colour, bronze or iris.

For the CAVE handle covered in Eco Skin, add a supplementary charge each

No reductions of any kind can be made on drawers, trays and pairs of side panels.

The pairs of side panels p. 153 price list or structures p. 154 price list are necessary for inserting all the elements. Compositions must be completed with an upper shelf (p. 133 price list) or glass cover p. 139 price list.

Warnings on using compartments adjacent to the corner element

It is impossible to use trouser or trinket trays (used individually).

Wood and open drawer finishes

Front:

- melamine structure
- piqué
- matt lacquer colours
- wood

Inside:

- saffiano grey melamine

Items available

Wooden drawers

Open drawers only lower handle

Handle finishes:
pewter colour
bronze
iris

Upper handle

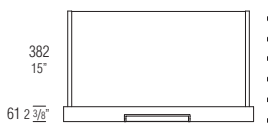
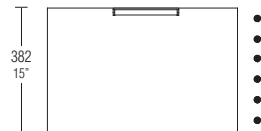
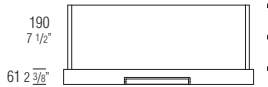
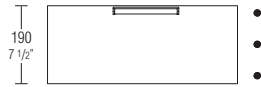
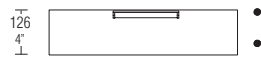

416 - 580 - 716 - 880 - 1208
16 3/8 - 22 7/8 - 28 1/4 - 34 5/8 - 47 1/2

416 - 580 - 716 - 880 - 1208
16 3/8 - 22 7/8 - 28 1/4 - 34 5/8 - 47 1/2

Lower handle

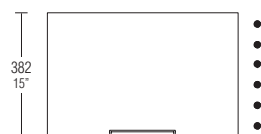
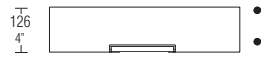

416 - 580 - 716 - 880 - 1208
16 3/8 - 22 7/8 - 28 1/4 - 34 5/8 - 47 1/2

GLISS
MASTER—
VINCENT
VAN DUYSSEN
2015

CAVE handle

Trouser holder/laundry sack tray finishes

Front:
- melamine structure
- piqué
- matt lacquer colours
- wood
Internal frame:
- saffiano grey melamine with trouser rods
painted in textured saffiano grey

Laundry sack:
- natural ecru cotton

Trinket tray finishes

Front:
- melamine structure
- piqué
- matt lacquer colours
- wood
Internal frame, bottom, and grid:
- saffiano grey melamine

Pull-out shelf finishes

Front:
- melamine structure
- piqué
- matt lacquer colours
- wood
Surface and back:
- saffiano grey melamine

57—
64

Trouser holder only upper handle

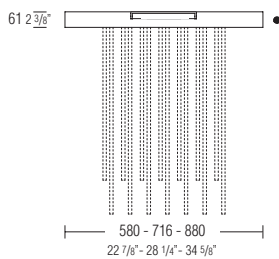

N.B.: usable only with suspended side panels
as the bottom piece

Trinket trays (tie and belt) with internal grid only upper handle

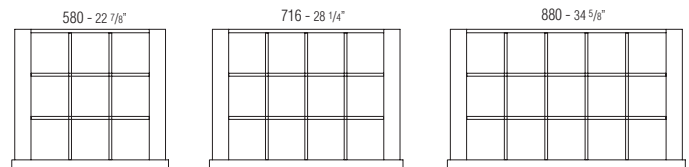
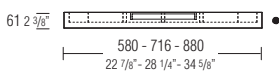

internal tray dividers

Pull-out trays only lower handle

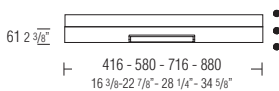

Tray laundry sack only upper handle

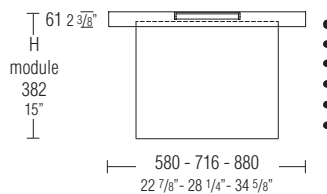

if the tray is
suspended
as a lower element
consider (—)

HOLD handle

Internal fittings - modular drawers and trays

Notes

The parts of this internal fittings are produced with width and height dimensions corresponding to the modular compartments. This makes it possible to organise the internal spaces in a number of ways. To correctly and quickly determine the internal fittings, some of the possible compositions are in the following pages.

The pairs of side panels p. 153 price list or structures p. 154 price list are necessary for inserting all the elements. Compositions must be completed with an upper shelf (p. 133 price list) or glass cover p. 139 price list.

When ordering, specify the handle finish as pewter colour, bronze or iris.

No reductions of any kind can be made on drawers, trays and pairs of side panels.

Warnings on using compartments adjacent to the corner element

It is impossible to use trouser or trinket trays (used individually).

Wood drawer finishes

Front:

- melamine structure
- piqué
- matt lacquer colours
- wood
- fine grain with pewter colour, bronze or iris profile

Inside:

- saffiano grey melamine

Glass drawer finishes

Front:

- transparent glass with pewter colour, bronze or iris frame

Inside:

- saffiano grey melamine

Open drawer finishes

Front:

- melamine structure
- piqué
- matt lacquer colours
- wood

Inside:

- saffiano grey melamine

Items available

Wooden drawers

HOLD handle (pewter colour, bronze or iris finish)



416 - 580 - 716 - 880 - 1208
16 3/8" - 22 7/8" - 28 1/4" - 34 5/8" - 47 1/2"

Glass drawers



416 - 580 - 716 - 880 - 1208
16 3/8" - 22 7/8" - 28 1/4" - 34 5/8" - 47 1/2"

Open drawers

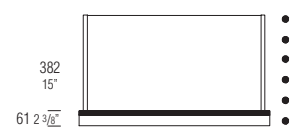

416 - 580 - 716 - 880 - 1208
16 3/8" - 22 7/8" - 28 1/4" - 34 5/8" - 47 1/2"

GLISS
MASTER—
VINCENT
VAN DUYSSEN
2015

HOLD handle

Trouser holder/laundry sack tray finishes

Front with pewter colour, bronze or iris profile:

- melamine structure
- piqué
- matt lacquer colours
- wood
- fine grain

Internal frame:

- saffiano grey melamine with trouser rods painted in textured saffiano grey

Laundry sack:

- natural ecru cotton

Trinket tray finishes

Front with pewter colour, bronze or iris profile:

- melamine structure
- piqué
- matt lacquer colours
- wood
- fine grain

Internal frame, bottom, and grid:

- saffiano grey melamine

Pull-out shelves finishes

Front:

- melamine structure
- piqué
- matt lacquer colours
- wood

Surface and back:

- saffiano grey melamine

HOLD handle (pewter colour, bronze or iris finish)



59—
64

Trouser holder

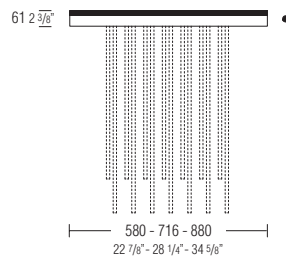

N.B.: usable only with suspended side panels
as the bottom piece

Trinket trays (tie and belt) with internal grid

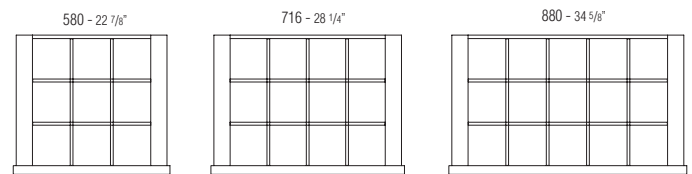
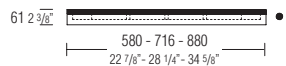

internal tray dividers

Pull-out trays

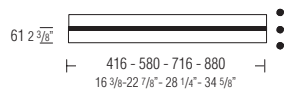

Tray laundry sack

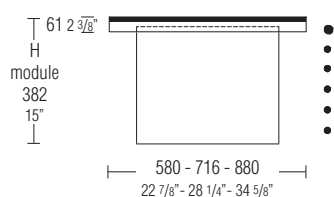

if the tray is
suspended
as a lower element
consider (—)

EXAMPLES OF COMPOSITE DRAWER UNITS WITH CAVE HANDLE

Melamine faced drawers have upper and lower handles.
Trousers holder and trinket trays always have an upper handle;
pull-out trays and open drawers always have a lower handle.

**Melamine drawers
H 126/190/382**

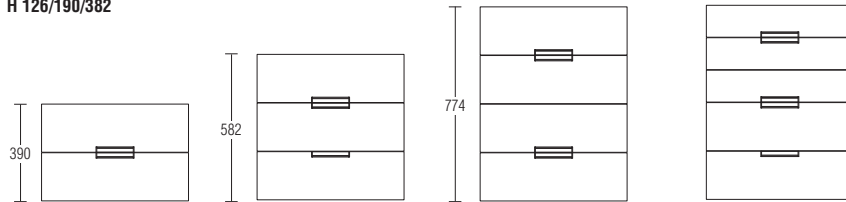

Trousers holders/trinket trays/laundry sack tray

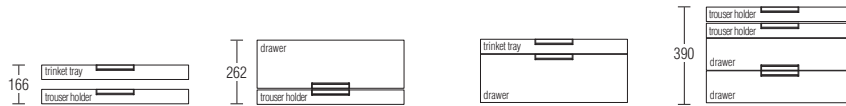

Pull-out trays

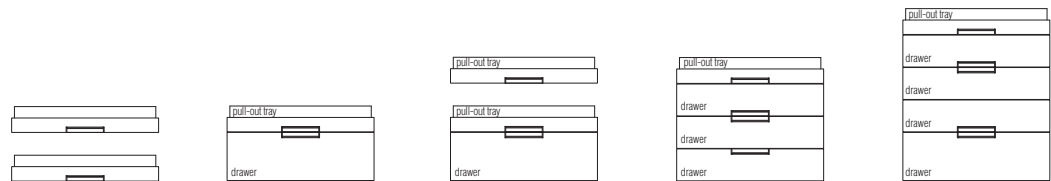

Open drawers

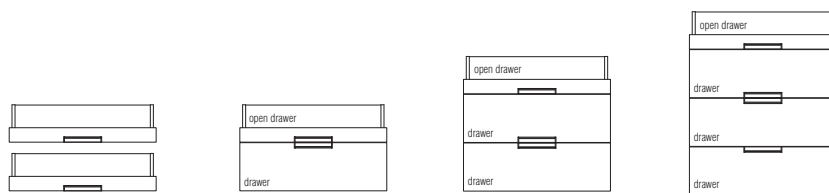

INTERNAL FITTINGS - ACCESSORIES FOR DRAWERS

Leather trays
 Handmade leather trays with Alcantara bottom.
 The version for men is brown (cat. P col. D533),
 The version for women is powder pink (cat. P col. D524).

Eco Skin bottoms
 Made with grey coloured Eco Skin.

leather trays
men's drawers
 W 206 D 430 H 58 (A)
 W 206 D 215 H 58 (B)

watch holder
(A)

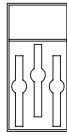

CEV/MA1

**watch/
bracelet holder**
(A)

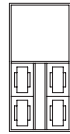

CEV/MA2

jewellery holder
with movable dividers
(B)



CEV/MB1

**complete men's
drawer offer**

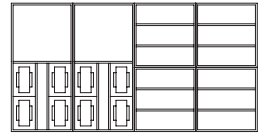

CVM1

61 —
 64

leather trays
women's drawers
 W 206 D 430 H 58 (A)
 W 206 D 215 H 58 (B)

watch holder
(A)

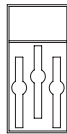

CEV/WA1

**watch/
bracelet holder**
(A)

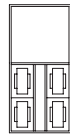

CEV/WA2

jewellery holder
with movable
dividers
(B)



CEV/WB1

ring holder
(B)



CEV/WB2

earring holder
(B)



CEV/WB3

**complete women's
drawer offer**



CVW1

Modularity drawings
for inserting trays into
drawers

drawer W 416

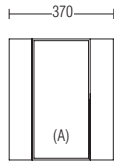

1 tray (A)
 or 2 trays (B)

drawer W 580

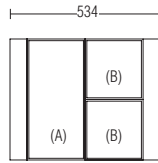

2 trays (A)
 or 4 trays (B)

drawer W 716

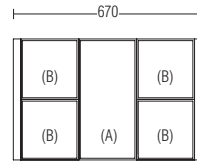

3 trays (A)
 or 6 trays (B)

drawer W 880

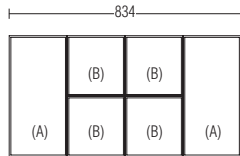

4 trays (A)
 or 8 trays (B)

drawer W 1208

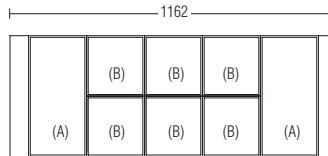

5 trays (A)
 or 10 trays (B)

Eco Skin bottoms
for drawers

D 432/473 special for 1st drawer with glass lid



W 366
CEQ/F4

W 530
CEQ/F6

W 666
CEQ/F8

W 830
CEQ/F9

W 1158
CEQ/F13

ISLAND DRAWER UNIT

Two versions are available: with or without trinket trays in dolomite lacquer. Shelves in Eco Skin are available in colours in the catalogue. Standard handles are mounted in pewter colour, bronze or iris finish. For the CAVE handle covered in Eco Skin, add a supplementary charge each.

version with trinket trays

- Side A has 6 drawers H 190 and 2 extractable trinket tray blocks.
- Side B has 4 drawers H 190 and and lower open compartments.

version without trinket trays

- Side A has 6 drawers H 190 and upper open compartment.
- Side B has 4 drawers H 190 and and lower open compartments.

Dimensions of the island cannot be reduced, and the composition cannot be modified.

Only for HOLD handle

It is possible to substitute the melamine drawers with glass drawers by adding the difference in price from **CLN8/19** and **CVN8/19**.

It is possible to substitute the melamine drawers with drawers with fine grain fronts by adding the difference in price of the finishes of the code **CLN8/19**.

island drawer unit with trinket trays

W 1518 D 1022 H 897
W 59 3/4" D 40 1/4" H 35 3/8"

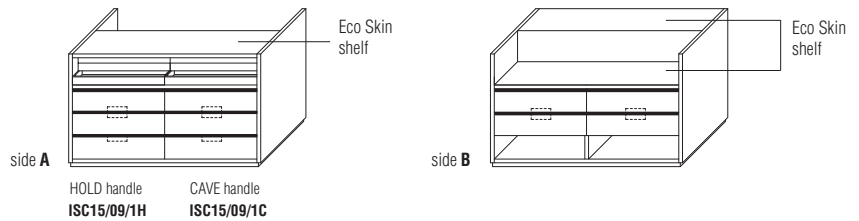

island drawer unit without trinket trays

W 1518 D 1022 H 897
W 59 3/4" D 40 1/4" H 35 3/8"

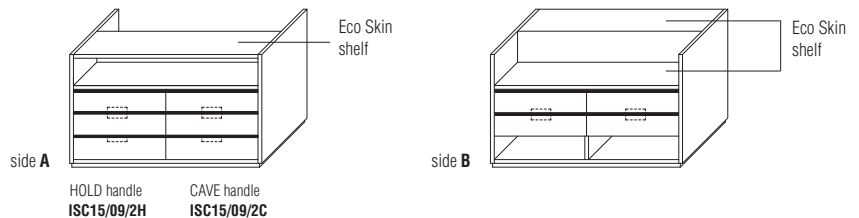

Drawer unit

Standard handles are mounted, in pewter colour, bronze or iris finish.

drawer unit

W 1292 D 527 H 897
W 50 7/8" D 20 3/4" H 35 3/8"

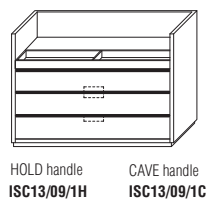

ISLAND WITH GLASS TOP

Island with glass top

Island finishes

silver cembran
 larix dark
 light chestnut
 dark chestnut
 matt lacquer colours in the Molteni colour range

Handles / top profile finishes

pewter colour
 bronze
 iris

No reductions of any kind are possible

For the CAVE handle covered in Eco Skin, add a supplementary charge each.

Notes

The divider grids are specific for upper drawers.
 If dividers are desired in the other drawers,
 use those shown on pages 159/162 of the price list.

63—
 64

island with glass top
 W 1272 D 1022 H 864
 W 50 1/8" D 40 1/4" H 34"

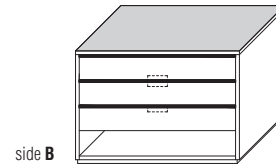
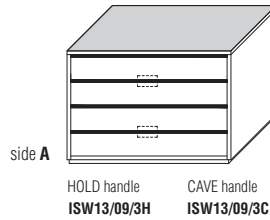

island with glass top
 W 1498 D 1022 H 864
 W 59" D 40 1/4" H 34"

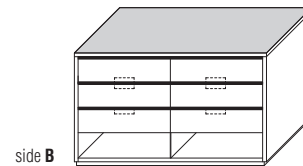
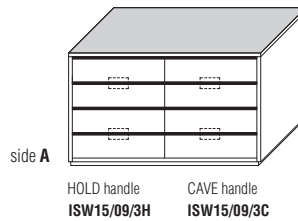

accessories for upper drawer

partition grid

grey saffiano
 W 666 D 443 W 1158 D 443
 W 26 1/4" D 17 1/2" W 45 5/8" D 17 1/2"

Eco Skin bottom

grey
 W 666 D 443 W 1158 D 443
 W 26 1/4" D 17 1/2" W 45 5/8" D 17 1/2"



CEGD/28



CEGD/33



CEQ/F28



CEQ/F33

GLISS
MASTER—
VINCENT
VAN DUYSSEN
2015

ISLAND WITH TRANSPARENT GLASS DOORS

Island that can be created with structure in transparent glass and horizontal parts in wood. Shelves are in wood except for those indicated (*) which are always in glass.

The island cannot be reduced or modified with respect to the versions in the price list.

Structure finish

pewter colour
bronze
iris

Base unit / top / shelf finishes

eucalyptus
graphite oak

H 880 - 34 5/8"
with top
D 1000 - 39 3/8"

W 1673 - 65 7/8"

W 2001 - 78 3/4"

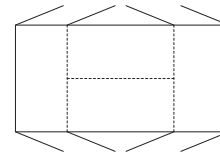
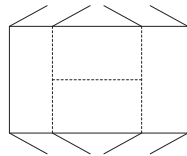
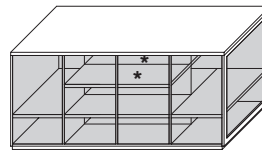
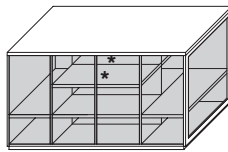

ISV16/08

ISV20/08

64 —
64

The island is available with or without LED lighting applied on all shelves and tops as shown. The system includes the cable holders and power supply units that enable it to work with a remote control.

front

back

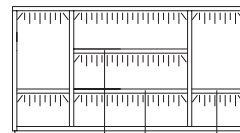
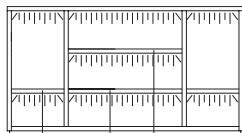

*
glass
shelves
wood
shelves