

Molteni & C

FILIGREE — RODOLFO DORDONI 2013

1—
3



Filigree is a range of fixed size and extension tables. Glossy and matt diecast aluminium frames underpin tops enhanced by a wide range of finishes. The technology used in the discreet Filigree main element allows an extendable table with an invisible lateral telescopic system. The entire top is without cuts, and extends to double its size. It allows the maximum use of space thanks to the outer legs, minimum thickness of the tops, and above all its mechanism containment structure and extensions which are only 38 mm internal thickness. The tables are available in different materials and finishes to meet all needs.

DATASHEET

REGISTERED
DESIGN

IX.2019

FINISHES

TOP FINISHES

woods (eucalyptus, grey oak, graphite oak, walnut) - coloured glass in the Molteni colour range (only for fixed tables) - etched coloured glass in the Molteni colour range (only for fixed tables) - Fenix white or anthracite (only for extendable table) - black marquina marble (only for fixed tables) - emperador dark marble (only for fixed tables) - white Carrara marble (only for fixed tables) - orient grey marble (only for fixed tables) - Sahara noir marble (only for fixed tables) - calacatta gold marble (only for fixed tables) - glossy eucalyptus (only for fixed tables).

STRUCTURE FINISHES

glossy zinc - black chrome - pewter colour (satin finish) - eucalyptus (only for fixed tables) - walnut (only for fixed tables)

Molteni & C

TECHNICAL INFORMATION

FIXED TABLE STRUCTURE

Aluminium extrusion anodised, painted or clad with sliced Eucalyptus or Walnut wood, with internal metal frame and laminated struts.

EXTENDABLE TABLE STRUCTURE

Anodised extruded aluminium with internal metal frame and runners on extruded aluminium tracks. Telescopic cover profile of the extendable table in extruded plastic.

GLASS TOP

Transparent or etched extra light glass, tempered, th. 6 mm, painted in colours in the Molteni range.

WOOD TOP AND EXTENSIONS

Composite panel of medium density fibre and aluminium sheets, th. 1mm, covered in Oak (Quercus), Walnut (Juglans nigra) or Eucalyptus (Eucalyptus globulus) veneer, FENIX NTM®.

MARBLE TOP

Marble in Range finishes with anti-stain, water-repellent treatments.

FIXED TABLE BASE

Wood particleboard panel with painted melamine facing.

EXTENDABLE TABLE BASE

Medium density fibre composite panel with external surface in anodised aluminium sheet, th. 1mm.

LEG

In die cast aluminium shiny brushed, chromed, painted or clad in sliced Eucalyptus or Walnut wood. Internal metal brace and foot in non-slip plastic.

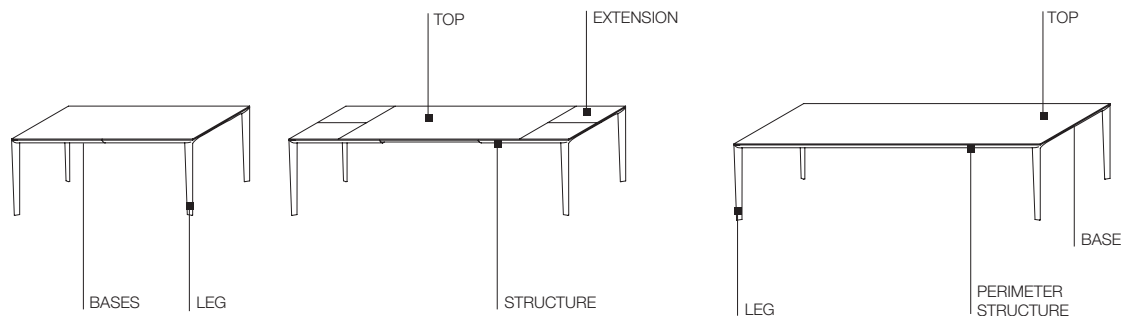

DATASHEET

REGISTERED
DESIGN

IX.2019

DIMENSIONS

extendable rectangular table

FTA18/10 closed

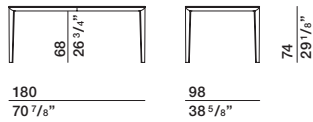

black chrome/
 pewter colour/
 glossy zinc
 structure

FTA18/10 partially open

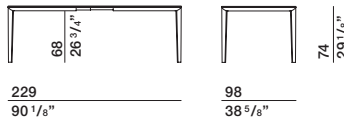

black chrome/
 pewter colour/
 glossy zinc
 structure

FTA18/10 fully open

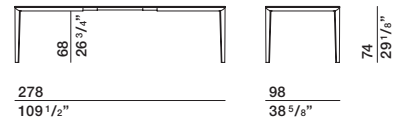

black chrome/
 pewter colour/
 glossy zinc
 structure

fixed rectangular tables

FTF18/10

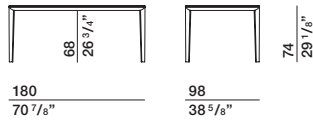

black chrome/ eucalyptus/
 pewter colour/ walnut
 glossy zinc structure

FTF21/10

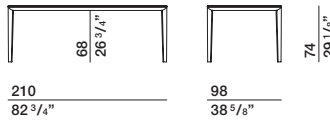

black chrome/ eucalyptus/
 pewter colour/ walnut
 glossy zinc structure

FTF24/10

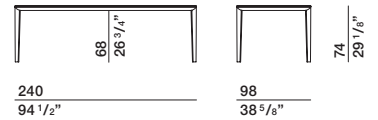

black chrome/ eucalyptus/
 pewter colour/ walnut
 glossy zinc structure

fixed rectangular table

FTF28/12

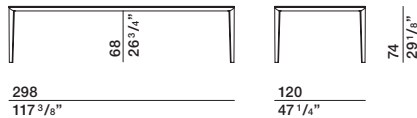

black chrome/ eucalyptus/
 pewter colour/ walnut
 glossy zinc structure

fixed square table

FTF15/15

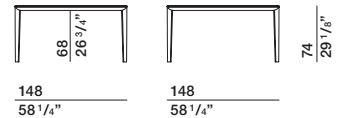

black chrome/ eucalyptus/
 pewter colour/ walnut
 glossy zinc structure