

Molteni & C

CLEO — VINCENT VAN DUYSSEN 2022

1—
6



Cleo is a modular system consisting of various rectilinear, angular and self-standing elements that allow for a large number of compositions suitable for all kinds of living. The heart of the project is the frame, which is used for each individual component. A harmonious curvilinear shell, recalling a cosy place, which embraces seat and back without a break. The shell, upholstered in textiles or in leather, like the seat cushions, offers great comfort. The possible combinations between the various upholstery materials for covering the frame and the seat cushions, can either make a contrast or emphasize the harmony of the two components. The rectangular back cushions can be placed at will to satisfy any requirements, guaranteeing comfort and allowing for different relaxation positions: from sitting comfortably to read a good book or spending time with loved ones, to lying down for a brief rest. Cleo is supported by feet made of a thin layer of varnished steel, designed to make the sofa look like an object floating in the living area, thus become heart and protagonist, thanks to its easy collocation even in the centre of the room. In addition, Cleo has rectilinear single frame solutions, suitable for creating a sofa with complete and enveloping shapes.



This symbol shows that the product has removable upholstery. Only qualified personnel can remove the upholstery of some of our products. If this information is pertinent, it will be included in the warnings section.



This symbol shows that the product is available on request in a fire resistant version that complies with the standards BS 5852 and TB 117-2013. The buyer is responsible for checking to make sure that the product is suitable and compliant with the requirements for the designated use and the current applicable laws and standards for the destination and use of the product.

DATASHEET

REGISTERED
DESIGN

IV.2022

TECHNICAL INFORMATION

EXTERNAL STRUCTURE

Frame made of plywood panels and wood cellulose fibreboard panels with thermosetting synthetic resin.
Cover in velveteen bonded with polyurethane.

INTERNAL CUSHIONING:

Padded back

Frame made of plywood panels and Polimex (polyester/polyurethane composite material), upholstered with high-bearing, variable-density polyurethane foam.
Cotton-polyester bonded velveteen lining.

Seat cushion

High-bearing, variable-density polyurethane foam and polyester fibre.
100% cotton cover.

BACK CUSHIONS

Polyester fibre. 100% cotton cover.

FEET

Pewter colour finish metal.

REMOVABLE OUTER COVER

(See attached card, specifically for the cover).



AVAILABLE IN FIRE-RESISTANT
VERSION TB117 AND BS5852

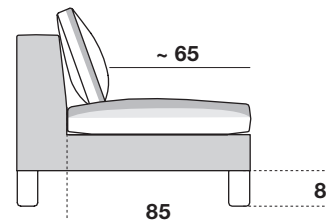
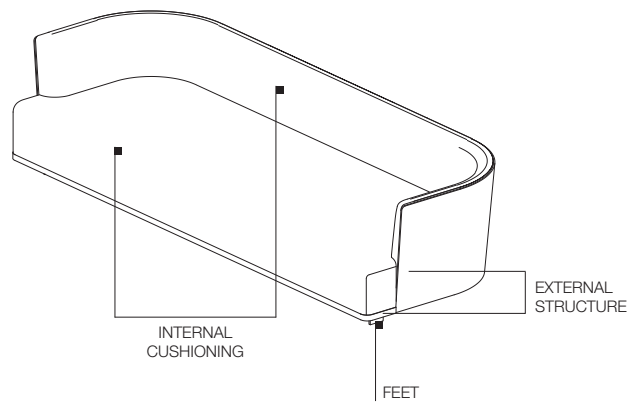

Seat depth for structure only, 85 cm
Seat depth with backrest cushion, ~ 65 cm
Feet high 8 cm (from ground to under seat)

DATASHEET

REGISTERED
DESIGN

IV.2022

RECOMMENDED BACK CUSHIONS CONFIGURATIONS



back cushion
W 45 H 45
CCS45



back cushion
W 55 H 50
CCS55



back cushion
W 75 H 50
CCS75

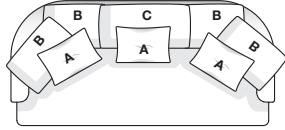

sofa W 210

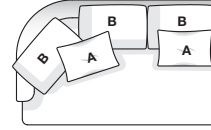

end element W 160 sx

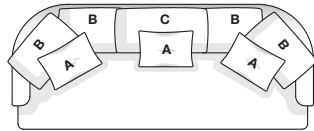

sofa W 240

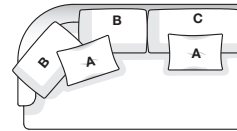

end element W 180 sx

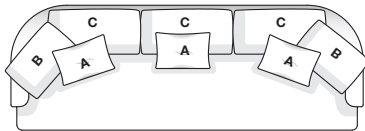

sofa W 280

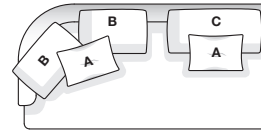

end element W 200 sx

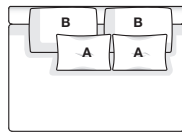

central element W 140

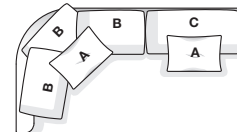

corner element W 180 dx

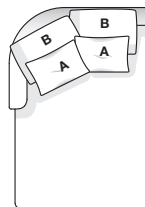

chaise longue D 160 sx

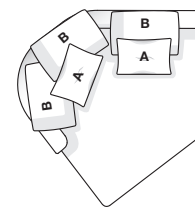

curved chaise longue W 162 sx

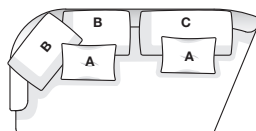

curved end element W 200 sx

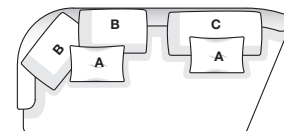

curved end element W 220 sx

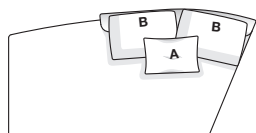

curved island element W 196,5 sx

NOTES

For optimal ergonomics and comfort, we recommend designing each module with one or more back cushions, using the measurements set forth in the price list. In addition to optimal ergonomics, these elements complete the product and ensure an elegant aesthetic appearance.

Molteni & C

3—
6

DATASHEET

REGISTERED
DESIGN

IV.2022

DIMENSIONS

Recommended configuration for back cushions:
nr. 4 - **CCS55**
nr. 1 - **CCS75**
nr. 3 - **CCS45**

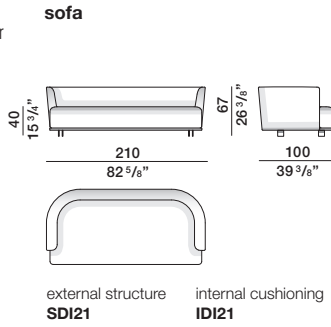

back cushion
CCS55

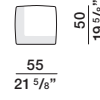

back cushion
CCS75

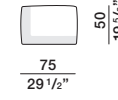

back cushion
CCS45

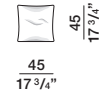

ornamental cushion
PCU90/75

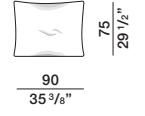

Recommended configuration for back cushions:
nr. 4 - **CCS55**
nr. 1 - **CCS75**
nr. 3 - **CCS45**

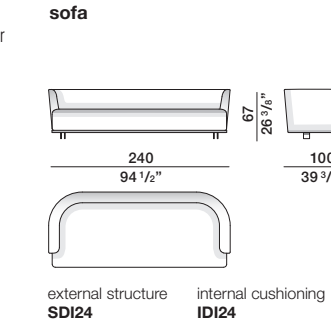

back cushion
CCS55

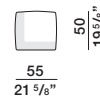

back cushion
CCS75

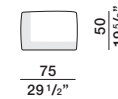

back cushion
CCS45

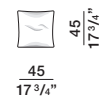

ornamental cushion
PCU90/75

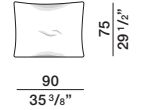

Recommended configuration for back cushions:
nr. 2 - **CCS55**
nr. 3 - **CCS75**
nr. 3 - **CCS45**

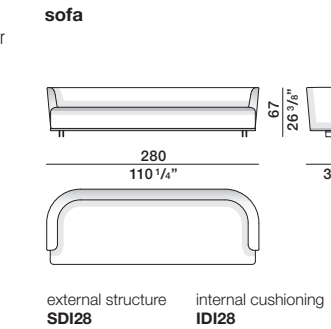

back cushion
CCS55

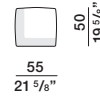

back cushion
CCS75

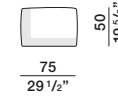

back cushion
CCS45

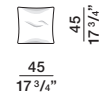

ornamental cushion
PCU90/75

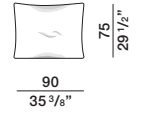

Recommended configuration for back cushions:
nr. 3 - **CCS55**
nr. 2 - **CCS45**

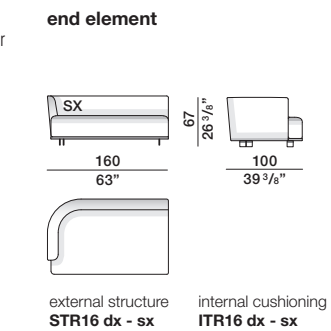

back cushion
CCS55

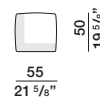

back cushion
CCS75

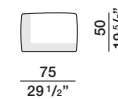

back cushion
CCS45

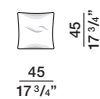

ornamental cushion
PCU90/75

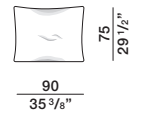

Recommended configuration for back cushions:
nr. 2 - **CCS55**
nr. 1 - **CCS75**
nr. 2 - **CCS45**

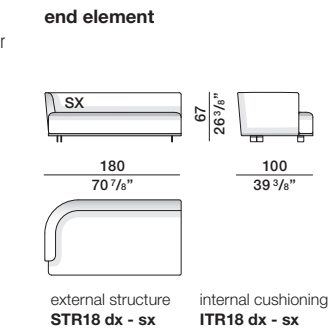

back cushion
CCS55

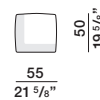

back cushion
CCS75

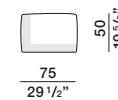

back cushion
CCS45

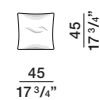

ornamental cushion
PCU90/75

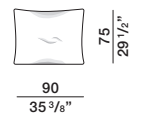

DATASHEET

REGISTERED
DESIGN

IV.2022

DIMENSIONS

Recommended configuration for back cushions:
nr. 2 - **CCS55**
nr. 1 - **CCS75**
nr. 2 - **CCS45**

end element

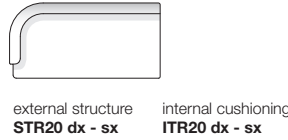
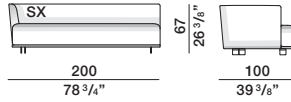

central element

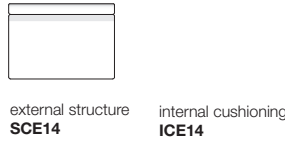
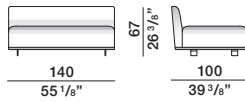

Recommended configuration for back cushions:
nr. 2 - **CCS55**
nr. 2 - **CCS45**

Recommended configuration for back cushions:
nr. 3 - **CCS55**
nr. 1 - **CCS75**
nr. 2 - **CCS45**

corner element

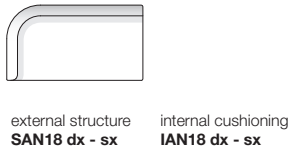
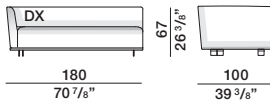

Recommended configuration for back cushions:
nr. 2 - **CCS55**
nr. 2 - **CCS45**

chaise longue

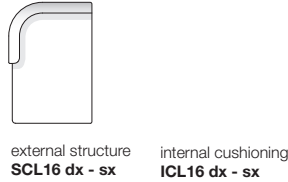
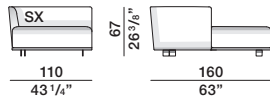

Recommended configuration for back cushions:
nr. 3 - **CCS55**
nr. 2 - **CCS45**

curved chaise longue

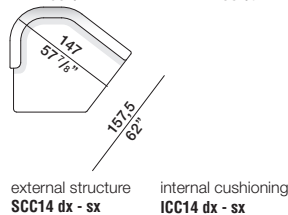
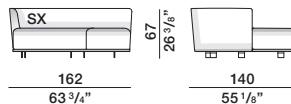

back cushion
CCS55

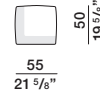

back cushion
CCS75

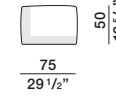

back cushion
CCS45

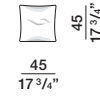

ornamental cushion
PCU90/75

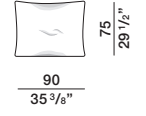

back cushion
CCS55

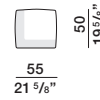

back cushion
CCS75

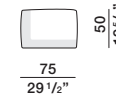

back cushion
CCS45

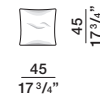

ornamental cushion
PCU90/75

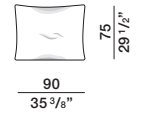

back cushion
CCS55

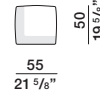

back cushion
CCS75

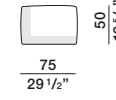

back cushion
CCS45

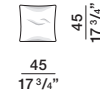

ornamental cushion
PCU90/75

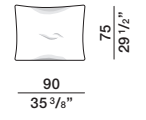

back cushion
CCS55

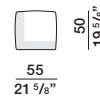

back cushion
CCS75

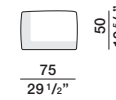

back cushion
CCS45

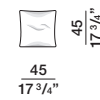

ornamental cushion
PCU90/75

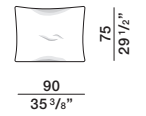

back cushion
CCS55

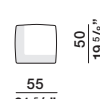

back cushion
CCS75

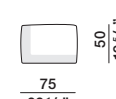

back cushion
CCS45

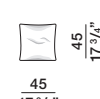

ornamental cushion
PCU90/75

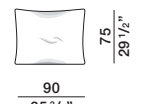

DATASHEET

REGISTERED
DESIGN

IV.2022

DIMENSIONS

Recommended configuration for back cushions:
nr. 2 - **CCS55**
nr. 1 - **CCS75**
nr. 2 - **CCS45**

curved end element

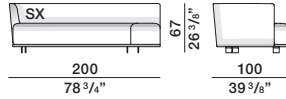

external structure **STC20 dx - sx** internal cushioning **ITC20 dx - sx**

back cushion
CCS55

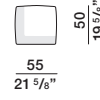

back cushion
CCS75

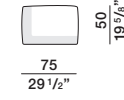

back cushion
CCS45

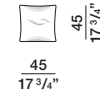

ornamental cushion
PCU90/75

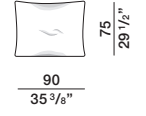

Recommended configuration for back cushions:
nr. 2 - **CCS55**
nr. 1 - **CCS75**
nr. 2 - **CCS45**

curved end element

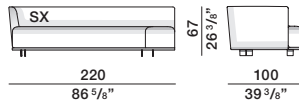

external structure **STC22 dx - sx** internal cushioning **ITC22 dx - sx**

back cushion
CCS55

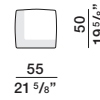

back cushion
CCS75

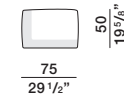

back cushion
CCS45

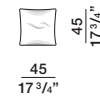

ornamental cushion
PCU90/75

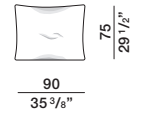

Recommended configuration for back cushions:
nr. 2 - **CCS55**
nr. 1 - **CCS45**

curved island element

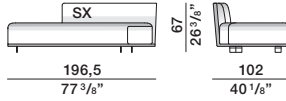

external structure **SIC20 dx - sx** internal cushioning **IIC20 dx - sx**

back cushion
CCS55

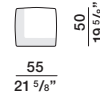

back cushion
CCS75

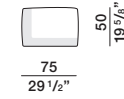

back cushion
CCS45

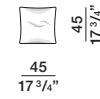

ornamental cushion
PCU90/75

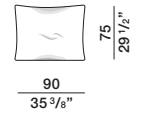

pouf

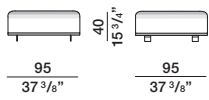

base **SPF95** seat cushion **IPF95**

DATASHEET

REGISTERED
DESIGN

IV.2022