

## ALISEE — MATTEO NUNZIATI 2020

1—  
3



A complete and perfectly calibrated system of furnishings suitable for all rooms of the home, it surprises with its aesthetic balance and the rigorous proportions of the individual components. The structure of the table creates a rhythm between solids and voids, enhanced by two finishes: pewter colour and glossy antique Gold. The two surfaces enrich the top part in wood, marble, smoked glass, and wood at the bottom. Refined materials and workmanship, attention to detail, for a family of elegant and refined contemporary furnishings.

### DATASHEET

REGISTERED  
DESIGN

IX.2020

Dimensions in centimeters and inches. The right to discontinue and make changes is reserved. This information is based on the latest product information available at the time of printing.

ALISEE—  
MATTEO  
NUNZIATI  
2020

## FINISHES

### METALLIC STRUCTURE FINISH

glossy antique gold  
matt pewter colour

### LOWER SHELF FINISHES

eucalyptus  
black oak

### UPPER SHELF FINISHES

smoked glass  
marble  
(silver dune, silver wave,  
green alpine, Sahara noir,  
calacatta gold)  
eucalyptus  
black oak

## TECHNICAL INFORMATION

### SMALL TABLE STRUCTURE (PAINTED)

In steel with feet in non-slip plastic.

### WOOD TOPS

Chipboard panel covered with wood veneer.

### MARBLE TOP

Marble th 20 mm in the finishes indicated in the price list and specific for the model, with stain resistant and water-repellent treatment.

### CRYSTAL TOP

Smoked crystal glass th 10 mm.

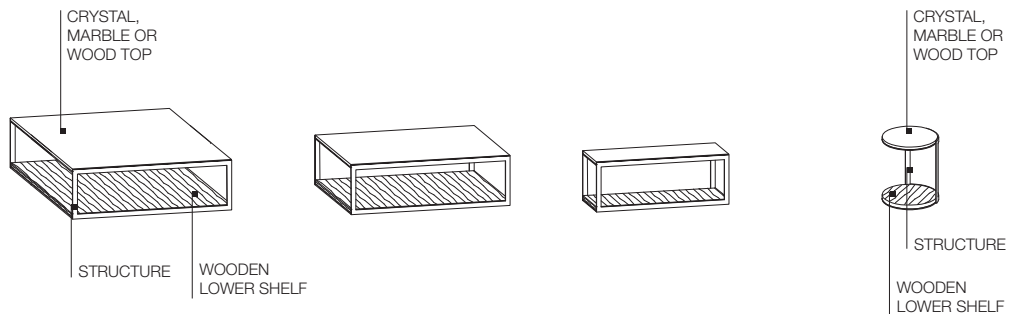

2—  
3

## DATASHEET

REGISTERED  
DESIGN

IX.2020

ALISEE – MATTEO NUNZIATI 2020

**DIMENSIONS**

**Notes**

- ▶ The lower shelf can only be in eucalyptus or in black oak.
- ▶ The small tables cannot be stacked and fastened together in adjacent positions.
- ▶ No reductions of any kinds or changes to finishes are available.

**Small tables**

Structure in matt pewter colour finish

ATQ1

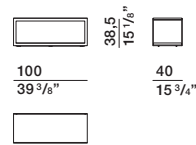

ATQ2

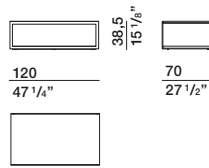

ATQ3

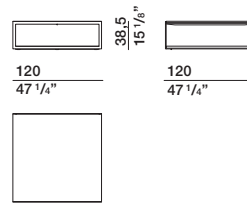

ATR1

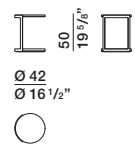

3  
3

**Small tables**

Structure in glossy antique gold finish

ATQ1

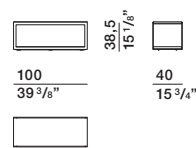

ATQ2

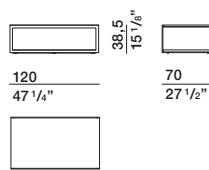

ATQ3

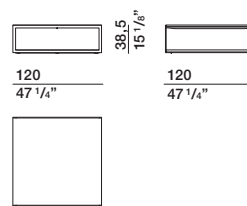

ATR1

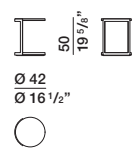

**DATASHEET**

REGISTERED DESIGN

IX.2020