

Valet Bar Cart

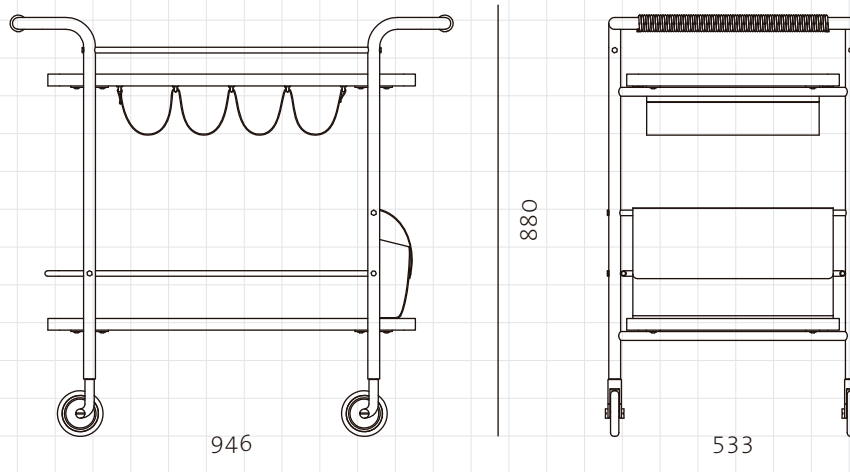

CODE

VA-CA110

DIMENSIONS

W946 x D533 x H880mm

NET WEIGHT

25.0 kg

ENVIRONMENT

Indoor

MATERIALS

Powder coated steel frame, Leather, Brass plated stainless steel, Veneer laminate boards

*Please refer to website or contact your local representative for complete material swatches.

SHIPPING

Package	Knock Down		
Package Qty	1 pcs/box		
Packaging	Measurement (mm)	Volume (cbm)	Gross Weight (kg)
FCL	W995 x D595 x H375	0.22	29.0
LCL/AIR	W1015 x D615 x H470	0.29	36.0