

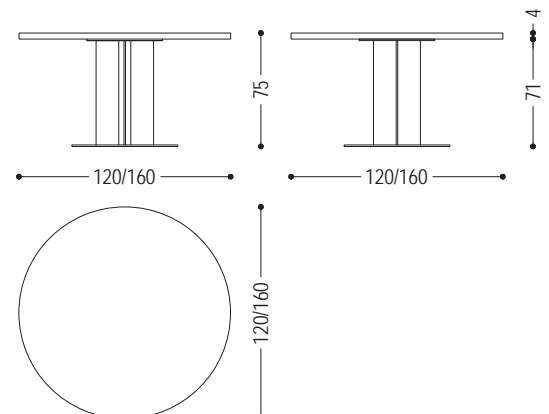

Table made with solid wood top in glued lists, in round shape. The iron base consists of a central leg and a floor plate.

CODE	SIZE	BASE	A1	A2	A4
NATURA-TONDO1	Ø 120 x H.75	B2	■	■	■
		B3	■	■	■
NATURA-TONDO2	Ø 140 x H.75	B2	■	■	■
		B3	■	■	■
NATURA-TONDO3	Ø 160 x H.75	B2	■	■	■
		B3	■	■	■

AVAILABLE FINISHES:

- A1:** walnut without knots, walnut with knots
- A2:** oak without knots, oak with knots, cherry
- A4:** oak without knots pigmented: white milk, total black
oak with knots pigmented: white milk, total black
- B2:** lacquered iron: iron dust, RAL (only selected colours)
- B3:** lacquered iron matt brushed effect: aged bronze, stainless steel, titanium



WOOD

A1



walnut without knots



walnut with knots

A2



oak without knots



oak with knots



cherry

A4

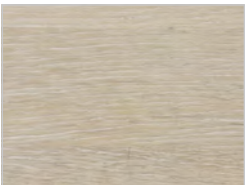

oak without knots pigmented:
white milk

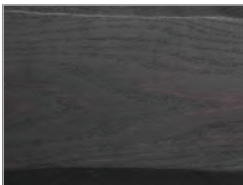

oak without knots pigmented:
total black



oak with knots pigmented:
white milk



oak with knots pigmented:
total black

IRON

B2

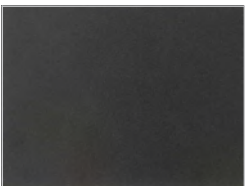

lacquered iron:
iron dust

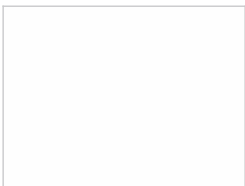

ferro laccato:
RAL - 1013_OYSTER WHITE



ferro laccato:
RAL - 3020_TRAFFIC RED

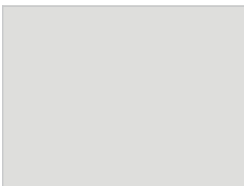

ferro laccato:
RAL - 7035_LIGHT GREY



ferro laccato:
RAL - 7037_DUSTY GREY

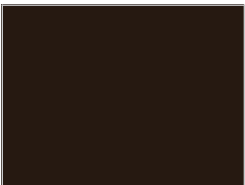

ferro laccato:
RAL - 8019_GREY BROWN

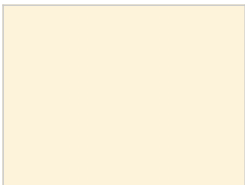

ferro laccato:
RAL - 9001_CREAM WHITE

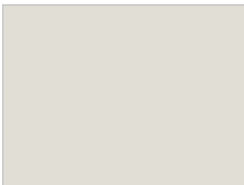

ferro laccato:
RAL - 9002_GREY WHITE

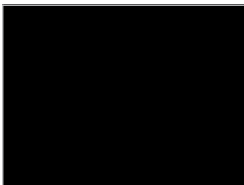

ferro laccato:
RAL - 9005_JET BLACK

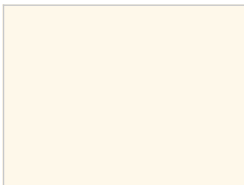

ferro laccato:
RAL - 9010_PURE WHITE

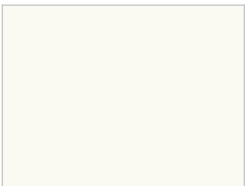

ferro laccato:
RAL - 9016_TRAFFIC WHITE

NATURA TONDO | AVAILABLE FINISHES

B3



lacquered iron, matt brushed effect:
aged bronze



lacquered iron, matt brushed effect:
stainless steel



lacquered iron, matt brushed effect:
titanium