

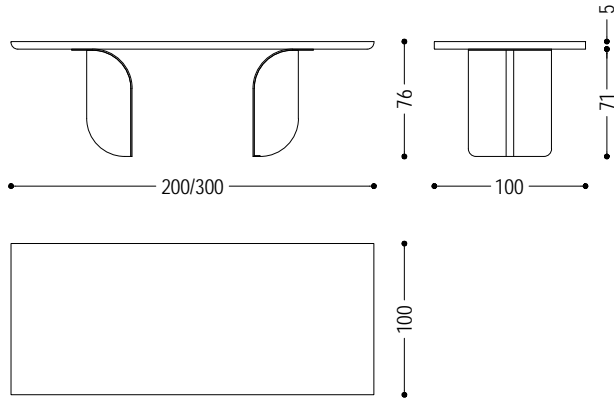

Table with a solid wood top with glued slats, with rounded corners, characterized by its legs, born from the union of iron and wood and created to look different depending on which angle they're seen from.









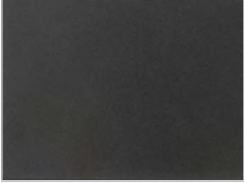
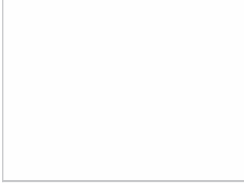

CODE	SIZE	BASE	A1	A2	A4
FORMA 1	W.200 x D.100 x H.76	B2	■	■	■
		B3	■	■	■
		B4	■	■	■
		B5	■	■	■
FORMA 2	W.220 x D.100 x H.76	B2	■	■	■
		B3	■	■	■
		B4	■	■	■
		B5	■	■	■
FORMA 3	W.240 x D.100 x H.76	B2	■	■	■
		B3	■	■	■
		B4	■	■	■
		B5	■	■	■
FORMA 4	W.260 x D.100 x H.76	B2	■	■	■
		B3	■	■	■
		B4	■	■	■
		B5	■	■	■
FORMA 5	W.280 x D.100 x H.76	B2	■	■	■
		B3	■	■	■
		B4	■	■	■
		B5	■	■	■
FORMA 6	W.300 x D.100 x H.76	B2	■	■	■
		B3	■	■	■
		B4	■	■	■
		B5	■	■	■

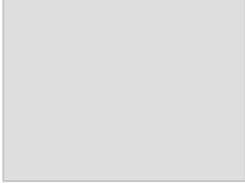
AVAILABLE FINISHES

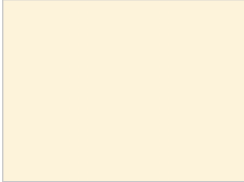
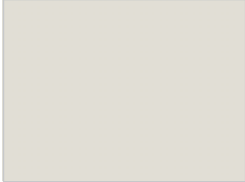

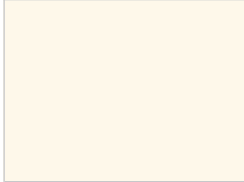
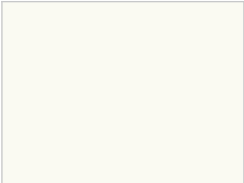
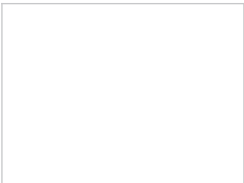



- A1:** walnut without knots, walnut with knots
- A2:** oak without knots, oak with knots, cherry
- A4:** oak without knots pigmented: white milk, total black
oak with knots pigmented: white milk, total black
- B2:** lacquered iron: iron dust, RAL (only selected colours)
- B3:** lacquered iron matt brushed effect: aged bronze, stainless steel, titanium
- B4:** lacquered iron: special RAL
- B5:** lacquered iron: bronze, cloudy effect

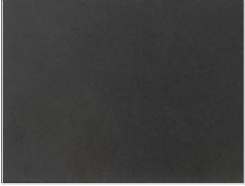
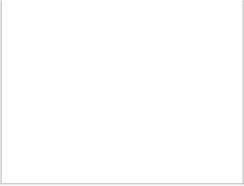

IRON

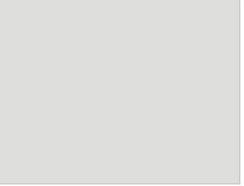
B2					
	lacquered iron: irondust	ferro laccato: RAL - 1013_OYSTER WHITE	ferro laccato: RAL - 3020_TRAFFIC RED	ferro laccato: RAL - 7035_LIGHT GREY	ferro laccato: RAL - 7037_DUSTY GREY
					
	ferro laccato: RAL - 8019_GREY BROWN	ferro laccato: RAL - 9001_CREAM WHITE	ferro laccato: RAL - 9002_GREY WHITE	ferro laccato: RAL - 9005_JET BLACK	ferro laccato: RAL - 9010_PURE WHITE
					
ferro laccato: RAL - 9016_TRAFFIC WHITE					
					
lacquered iron: special RAL					
B3					
	lacquered iron, matt brushed effect: aged bronze	lacquered iron, matt brushed effect: stainless steel	lacquered iron, matt brushed effect: titanium		

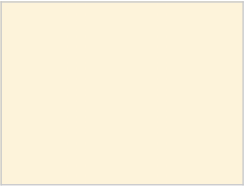
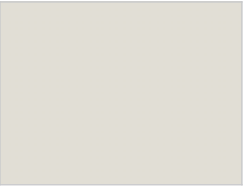
B2

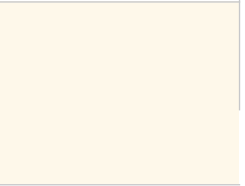
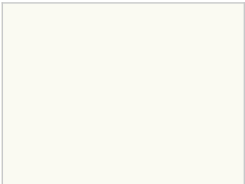
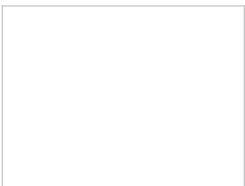
				
lacquered iron: irondust	ferro laccato: RAL - 1013_OYSTER WHITE	ferro laccato: RAL - 3020_TRAFFIC RED	ferro laccato: RAL - 7035_LIGHT GREY	ferro laccato: RAL - 7037_DUSTY GREY
				
ferro laccato: RAL - 8019_GREY BROWN	ferro laccato: RAL - 9001_CREAM WHITE	ferro laccato: RAL - 9002_GREY WHITE	ferro laccato: RAL - 9005_JET BLACK	ferro laccato: RAL - 9010_PURE WHITE
				
ferro laccato: RAL - 9016_TRAFFIC WHITE				
				
lacquered iron: special RAL				

B5

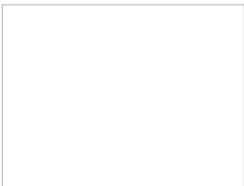
lacquered iron: bronze, cloudy effect

WOOD

A1

	
walnut without knots	walnut with knots

A2

		
oak without knots	oak with knots	cherry

A4



oak without knots pigmented:
white milk

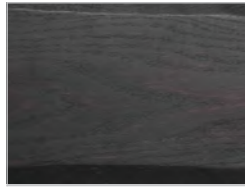

oak without knots pigmented:
total black



oak with knots pigmented:
white milk



oak with knots pigmented:
total black