



Table with top made of solid wood in glued lists, characterised by one leg passing through the top surface, made from a section of a tree trunk. Version with round top and floor plate in iron.

CODE	SIZE	PLATE	A1	A2
NAT-BOSSEXETONDO 1	Ø 120 x H.73,5	B2	■	■
		B3	■	■
NAT-BOSSEXETONDO 2	Ø 140 x H.73,5	B2	■	■
		B3	■	■
NAT-BOSSEXETONDO 3	Ø 160 x H.73,5	B2	■	■
		B3	■	■

**AVAILABLE FINISHES:**

**A1:** walnut with knots

**A2:** oak with knots

**B2:** lacquered iron: iron dust, RAL (only selected colours)

**B3:** lacquered iron matt brushed effect: aged bronze, stainless steel, titanium

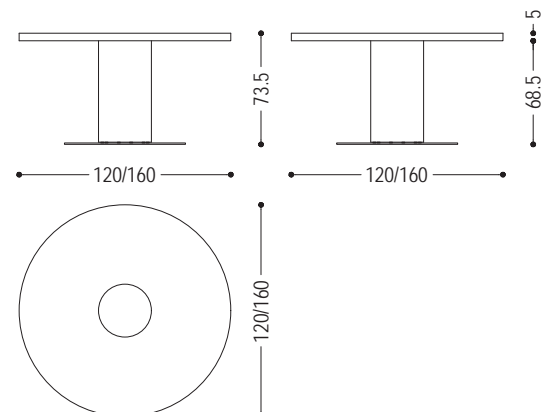

## WOOD

A1



walnut with knots

A2



oak with knots

## IRON

B2

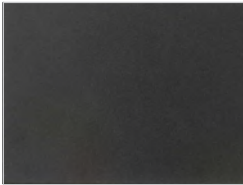

lacquered iron:  
irondust

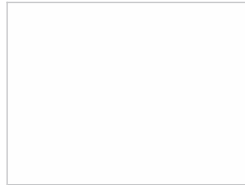

ferro laccato:  
RAL - 1013\_OYSTER WHITE



ferro laccato:  
RAL - 3020\_TRAFFIC RED

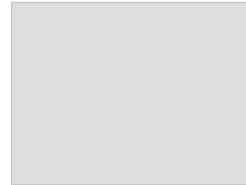

ferro laccato:  
RAL - 7035\_LIGHT GREY



ferro laccato:  
RAL - 7037\_DUSTY GREY

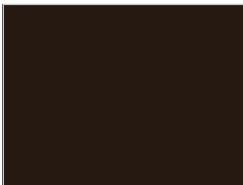

ferro laccato:  
RAL - 8019\_GREY BROWN

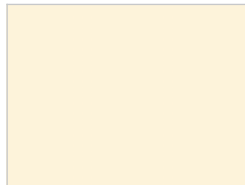

ferro laccato:  
RAL - 9001\_CREAM WHITE

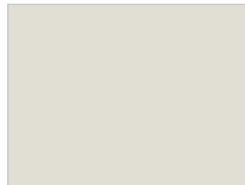

ferro laccato:  
RAL - 9002\_GREY WHITE

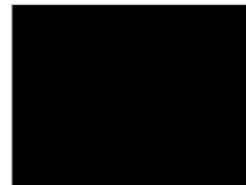

ferro laccato:  
RAL - 9005\_JET BLACK

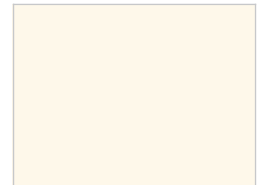

ferro laccato:  
RAL - 9010\_PURE WHITE

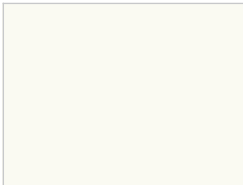

ferro laccato:  
RAL - 9016\_TRAFFIC WHITE

B3

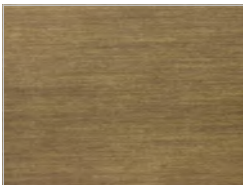

lacquered iron, matt brushed effect:  
aged bronze

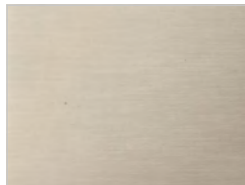

lacquered iron, matt brushed effect:  
stainless steel

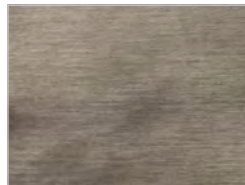

lacquered iron, matt brushed effect:  
titanium