



Table with top made of solid wood, consisting of two single planks with natural sides joined through a refined central resin filling. Walnut combined with transparent resin and oak combined with black resin. Base in iron plate characterised by geometric lines.

CODE	SIZE	BASE	A1	A2
BEDROCK-PLANK 1.DIR RESIN	W.220 x D.90/100 x H.76	B2	■	■
		B3	■	■
BEDROCK-PLANK 2.DIR RESIN	W.240 x D.90/100 x H.76	B2	■	■
		B3	■	■
BEDROCK-PLANK 3.DIR RESIN	W.260 x D.90/100 x H.76	B2	■	■
		B3	■	■
BEDROCK-PLANK 4.DIR RESIN	W.280 x D.90/100 x H.76	B2	■	■
		B3	■	■
BEDROCK-PLANK 5.DIR RESIN	W.300 x D.90/100 x H.76	B2	■	■
		B3	■	■

AVAILABLE FINISHES:

A1: walnut with knots

A2: oak with knots

B2: lacquered iron: iron dust, RAL (only selected colours)

B3: lacquered iron matt brushed effect: aged bronze, stainless steel, titanium

DETAIL: TOP IN WALNUT WITH KNOTS AND TRANSPARENT RESIN



DETAIL: TOP IN OAK WITH KNOTS AND BLACK RESIN

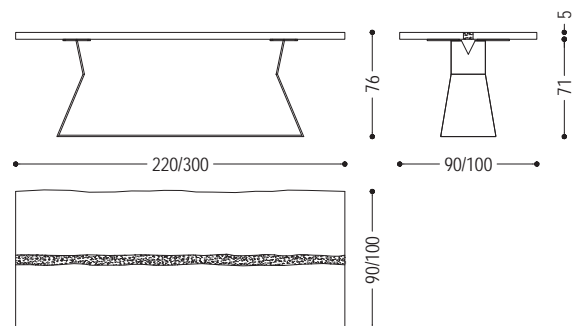

WOOD

A1



walnut with knots

A2



oak with knots

IRON

B2

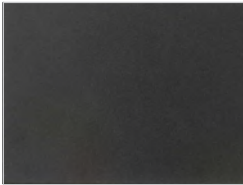

lacquered iron:
iron dust

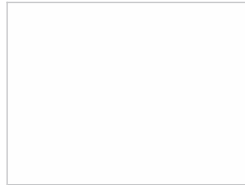

ferro laccato:
RAL - 1013_OYSTER WHITE



ferro laccato:
RAL - 3020_TRAFFIC RED

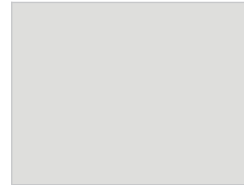

ferro laccato:
RAL - 7035_LIGHT GREY



ferro laccato:
RAL - 7037_DUSTY GREY

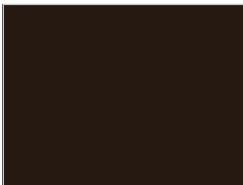

ferro laccato:
RAL - 8019_GREY BROWN

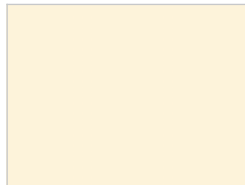

ferro laccato:
RAL - 9001_CREAM WHITE

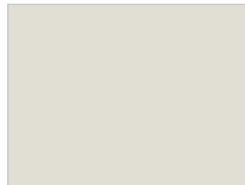

ferro laccato:
RAL - 9002_GREY WHITE

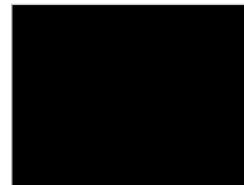

ferro laccato:
RAL - 9005_JET BLACK

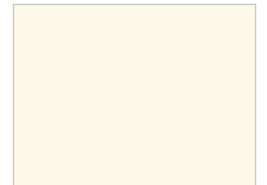

ferro laccato:
RAL - 9010_PURE WHITE

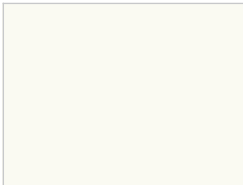

ferro laccato:
RAL - 9016_TRAFFIC WHITE

B3

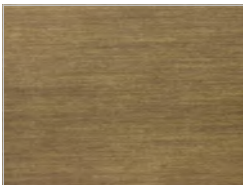

lacquered iron, matt brushed effect:
aged bronze

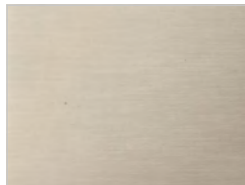

lacquered iron, matt brushed effect:
stainless steel

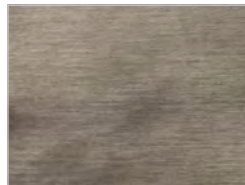

lacquered iron, matt brushed effect:
titanium