

## PUPPET SP G

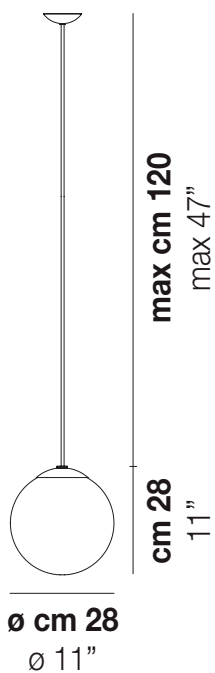

### TECHNICAL DATA:



### CERTIFICATIONS:



### LIGHTING SOURCES

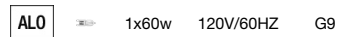

VOLUME Mc 0  
GROSS WEIGHT Kg 0  
NET WEIGHT Kg 0

download resources



### SHADE FINISHING



AM/TR

BC/SF

CR/TR

FU/TR

### FRAME FINISHING

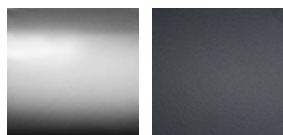

CR

NE

## OTHER AVAILABLE VERSIONS

Click on the version to go to the web version of the product

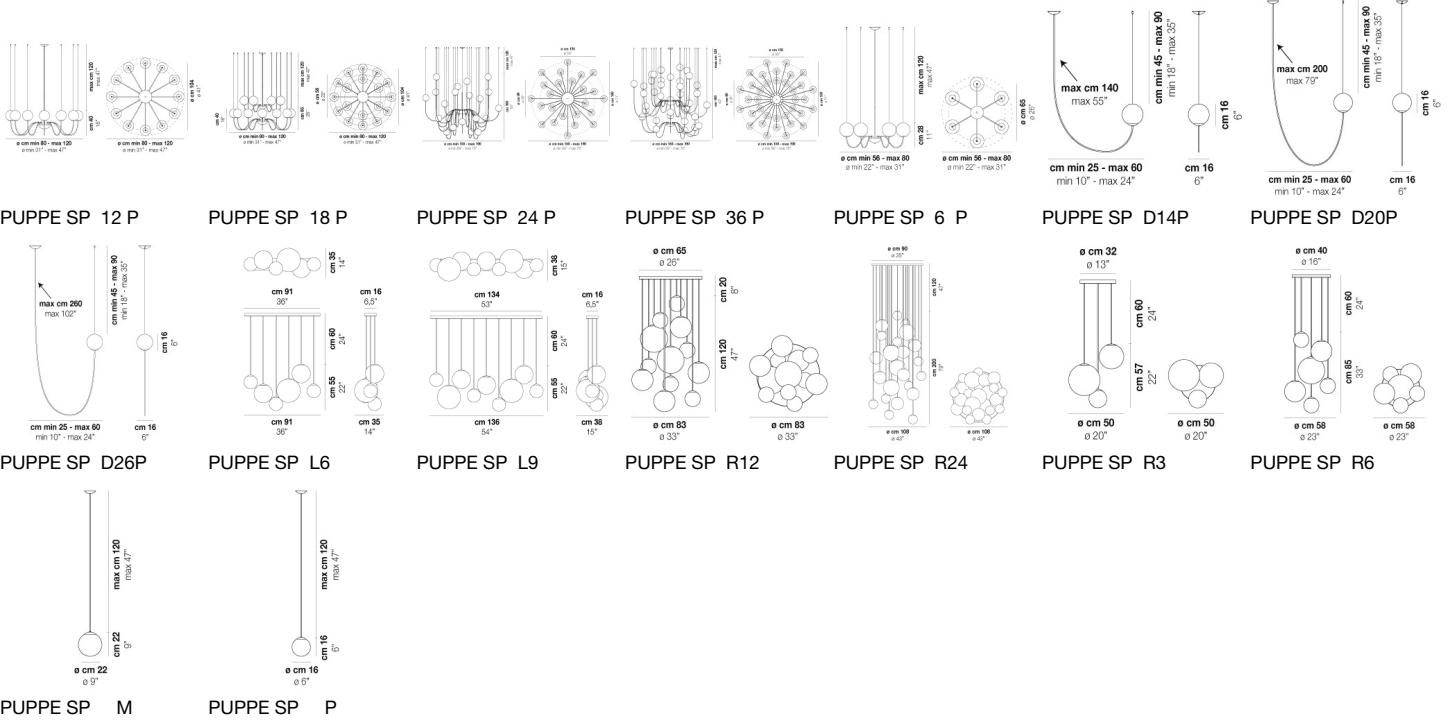

## PUPPET SP M

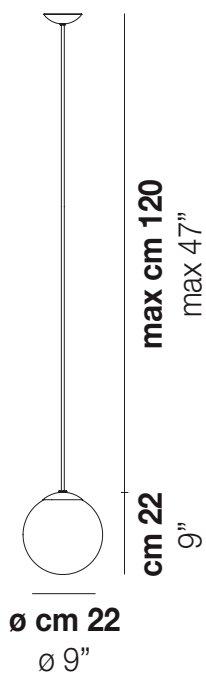

### TECHNICAL DATA:

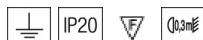

### CERTIFICATIONS:



### LIGHTING SOURCES

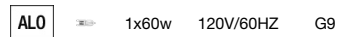

VOLUME Mc 0,05  
 GROSS WEIGHT Kg 0  
 NET WEIGHT Kg 0

download resources



### SHADE FINISHING



AM/TR

BC/SF

CR/TR

FU/TR

### FRAME FINISHING

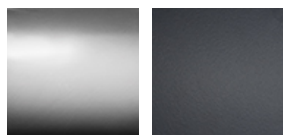

CR

NE

## OTHER AVAILABLE VERSIONS

Click on the version to go to the web version of the product

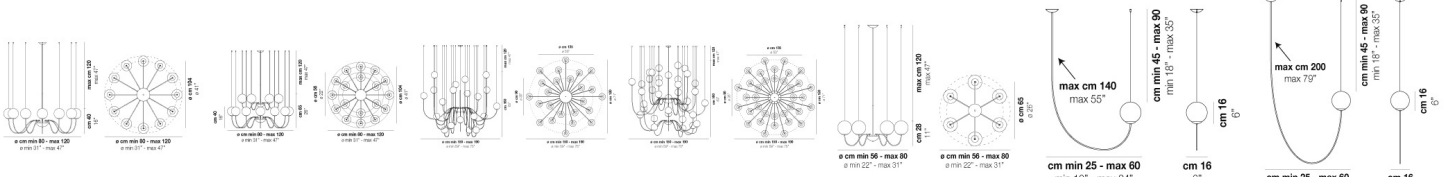

PUPPE SP 12 P

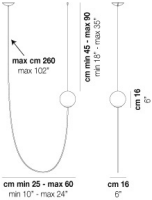

PUPPE SP 18 P

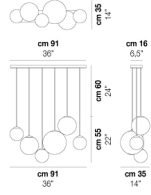

PUPPE SP 24 P

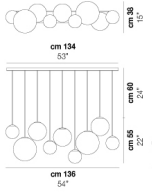

PUPPE SP 36 P

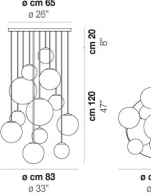

PUPPE SP 6 P

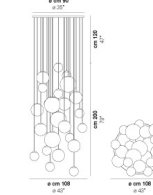

PUPPE SP D14P

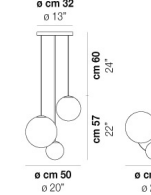

PUPPE SP D20P

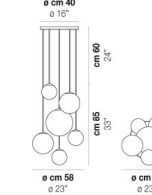

PUPPE SP D26P

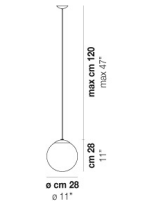

PUPPE SP L6

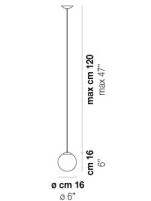

PUPPE SP L9



PUPPE SP R12



PUPPE SP R24



PUPPE SP R3



PUPPE SP R6



PUPPE SP G



PUPPE SP P



## PUPPET SP P

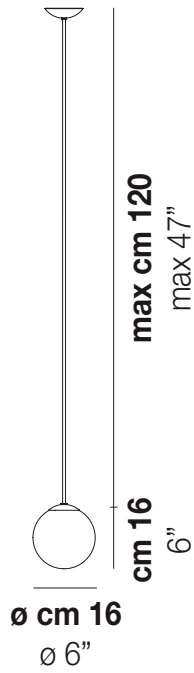

### TECHNICAL DATA:

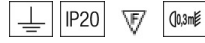

### CERTIFICATIONS:



### LIGHTING SOURCES

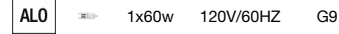

VOLUME Mc 0  
GROSS WEIGHT Kg 0  
NET WEIGHT Kg 0

download resources



### SHADE FINISHING

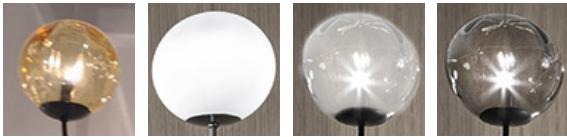

AM/TR

BC/SF

CR/TR

FU/TR

### FRAME FINISHING

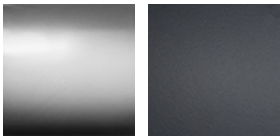

CR

NE

## OTHER AVAILABLE VERSIONS

Click on the version to go to the web version of the product

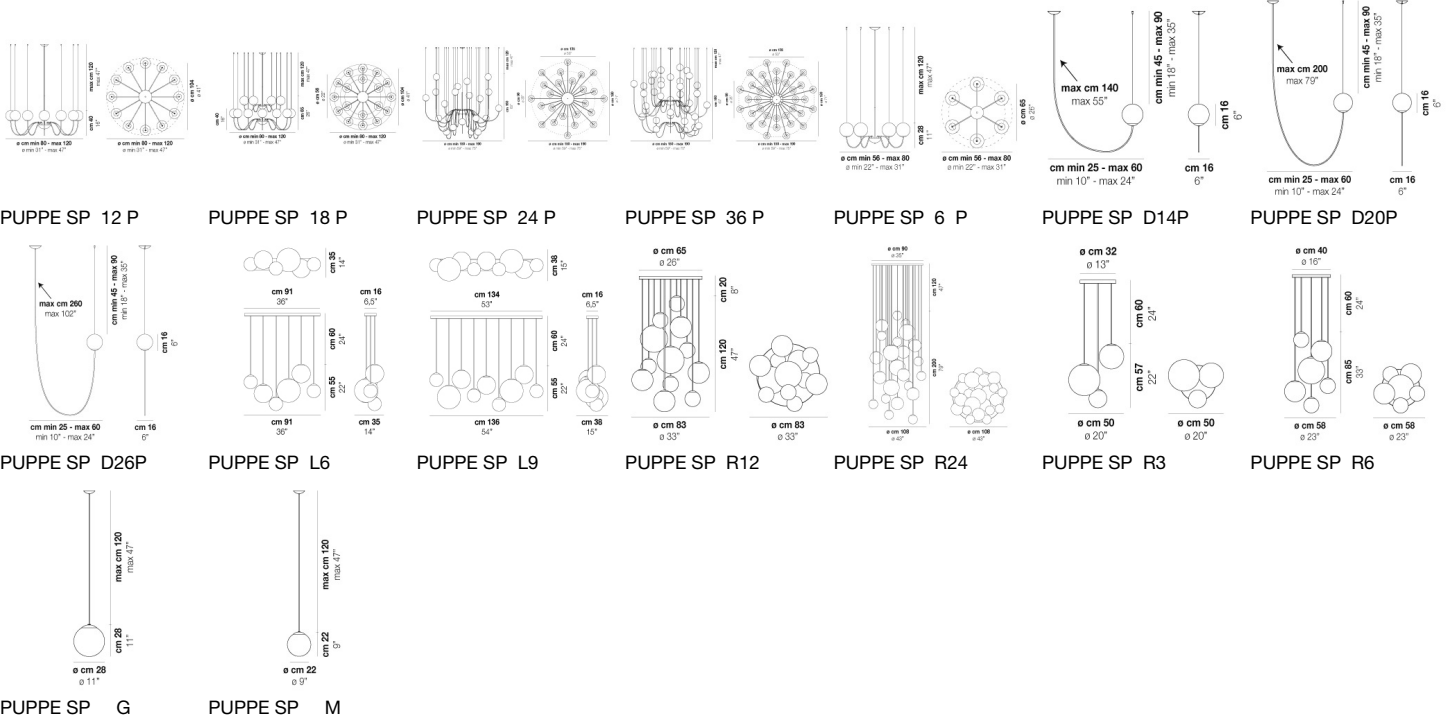

## PUPPET SP 6 P

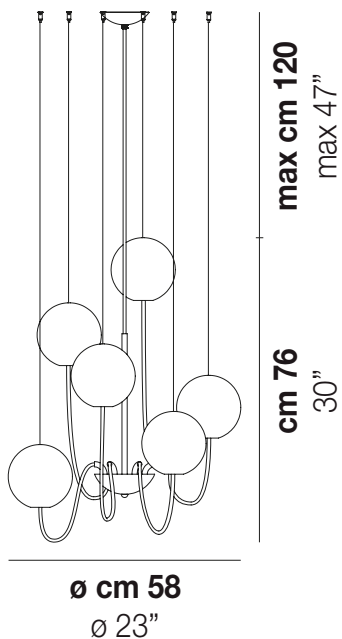

### TECHNICAL DATA:



### CERTIFICATIONS:



### LIGHTING SOURCES

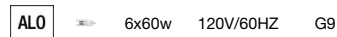

VOLUME Mc 0,1  
GROSS WEIGHT Kg 17  
NET WEIGHT Kg 9

download resources



### SHADE FINISHING



AM/TR

BC/SF

CR/TR

FU/TR

### FRAME FINISHING

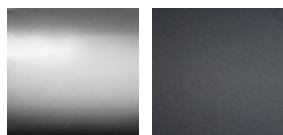

CR

NE

## OTHER AVAILABLE VERSIONS

Click on the version to go to the web version of the product

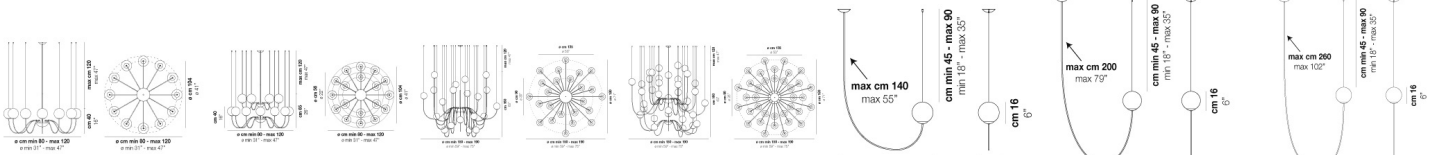

PUPPE SP 12 P

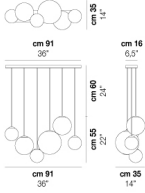

PUPPE SP 18 P

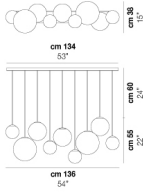

PUPPE SP 24 P

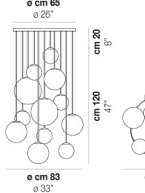

PUPPE SP 36 P

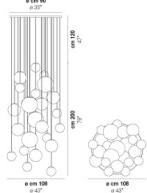

PUPPE SP D14P

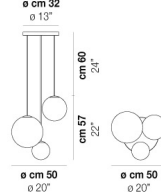

PUPPE SP D20P

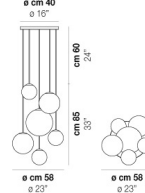

PUPPE SP D26P

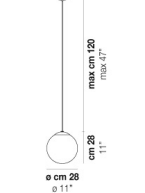

PUPPE SP L6



PUPPE SP L9



PUPPE SP R12



PUPPE SP R24



PUPPE SP R3



PUPPE SP R6

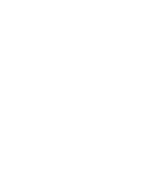

PUPPE SP G



PUPPE SP M

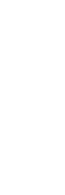

PUPPE SP P





## PUPPET SP 12 P

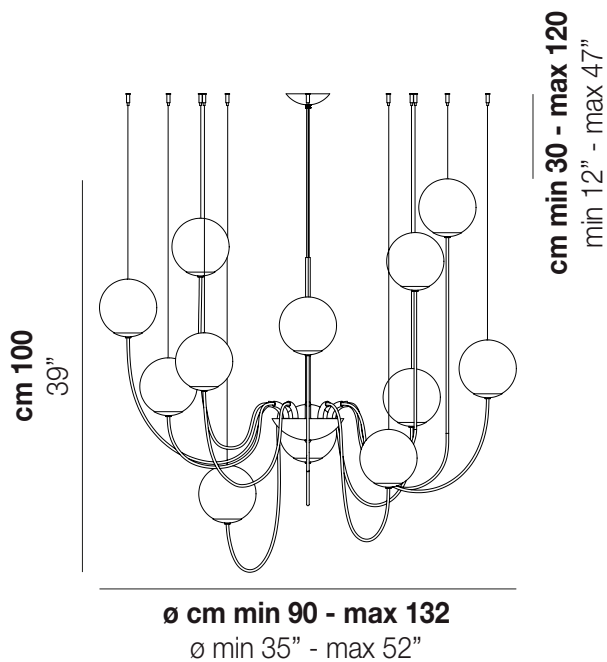

### TECHNICAL DATA:

### CERTIFICATIONS:



### LIGHTING SOURCES

ALO → 12x60w 120V/60HZ G9

VOLUME Mc 0,31  
GROSS WEIGHT Kg 28  
NET WEIGHT Kg 17

download resources



### SHADE FINISHING



AM/TR

BC/SF

CR/TR

FU/TR

### FRAME FINISHING

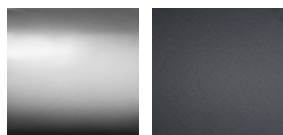

CR

NE

## OTHER AVAILABLE VERSIONS

Click on the version to go to the web version of the product

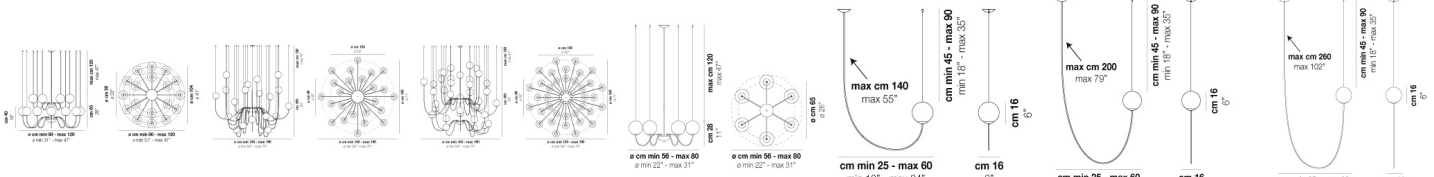

PUPPE SP 18 P

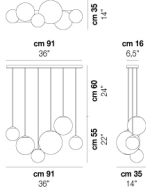

PUPPE SP 24 P

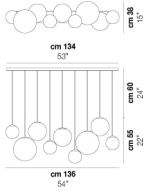

PUPPE SP 36 P

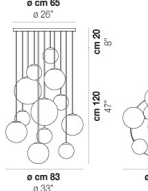

PUPPE SP 6 P

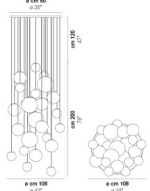

PUPPE SP D14P

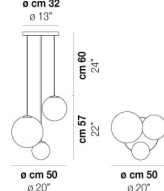

PUPPE SP D20P

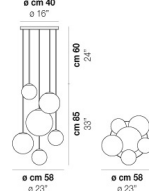

PUPPE SP D26P

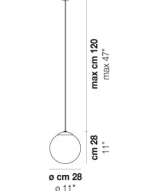

PUPPE SP L6

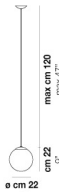

PUPPE SP L9

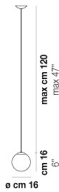

PUPPE SP R12



PUPPE SP R24



PUPPE SP R3



PUPPE SP R6



PUPPE SP G



PUPPE SP M



PUPPE SP P



## PUPPET SP 18 P

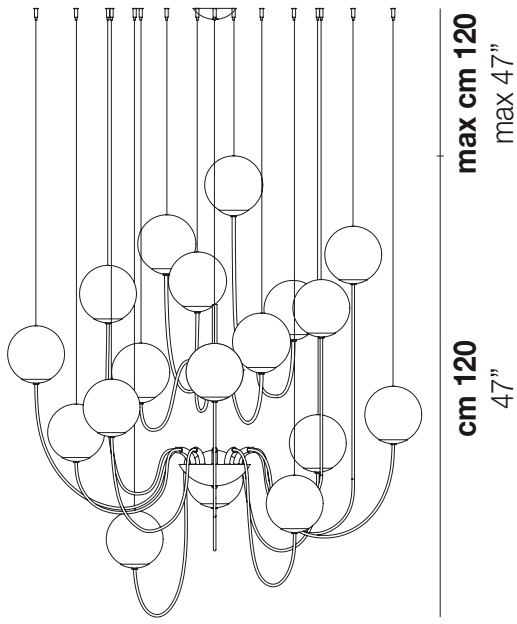

ø cm min 90 - max 132  
 ø min 35" - max 52"

### TECHNICAL DATA:



### CERTIFICATIONS:



### LIGHTING SOURCES

ALO 18x40w 120V/60HZ G9

VOLUME Mc 0,42  
 GROSS WEIGHT Kg 0  
 NET WEIGHT Kg 0

download resources



### SHADE FINISHING

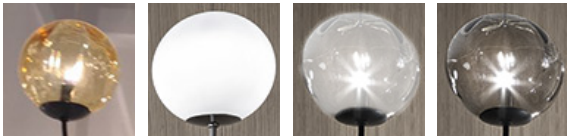

AM/TR

BC/SF

CR/TR

FU/TR

### FRAME FINISHING

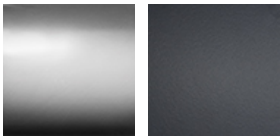

CR

NE



## PUPPET SP 24 P

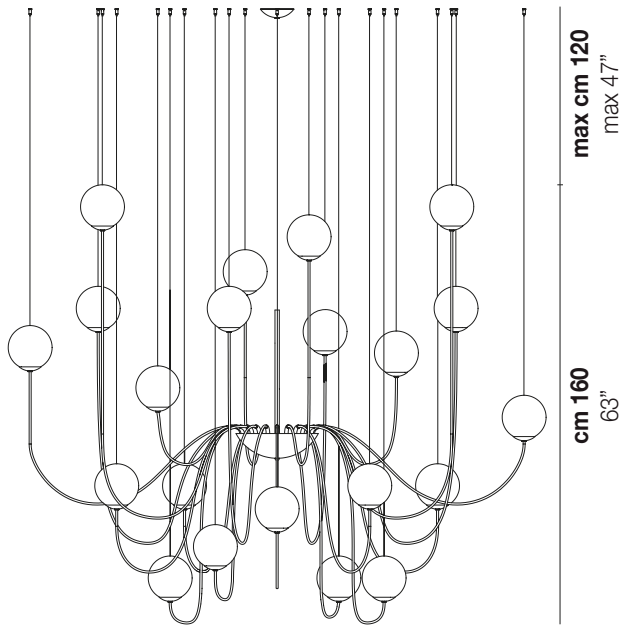

ø cm min 150 - max 190  
 ø min 59" - max 75"

### TECHNICAL DATA:

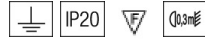

### CERTIFICATIONS:



### LIGHTING SOURCES

ALO → 24x25w 120V/60HZ G9

VOLUME Mc 0,62  
 GROSS WEIGHT Kg 56  
 NET WEIGHT Kg 34

download resources



### SHADE FINISHING

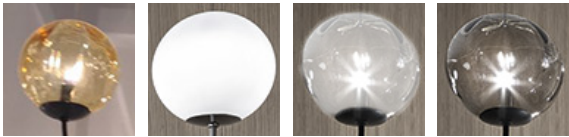

AM/TR

BC/SF

CR/TR

FU/TR

### FRAME FINISHING

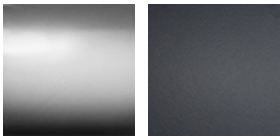

CR

NE

## OTHER AVAILABLE VERSIONS

Click on the version to go to the web version of the product

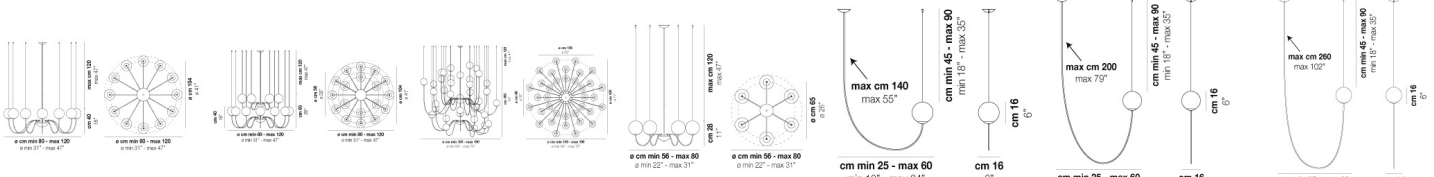

PUPPE SP 12 P

PUPPE SP 18 P

PUPPE SP 36 P

PUPPE SP 6 P

PUPPE SP D14P

PUPPE SP D20P

PUPPE SP D26P

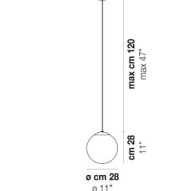
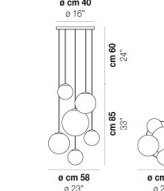
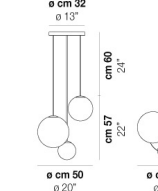
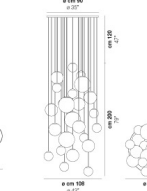
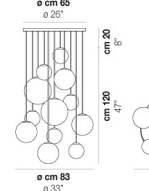
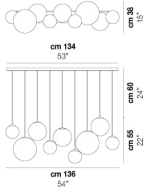
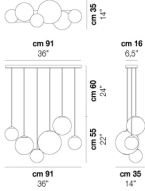

PUPPE SP L6

PUPPE SP L9

PUPPE SP R12

PUPPE SP R24

PUPPE SP R3

PUPPE SP R6

PUPPE SP G



PUPPE SP M

PUPPE SP P

## PUPPET SP 36 P

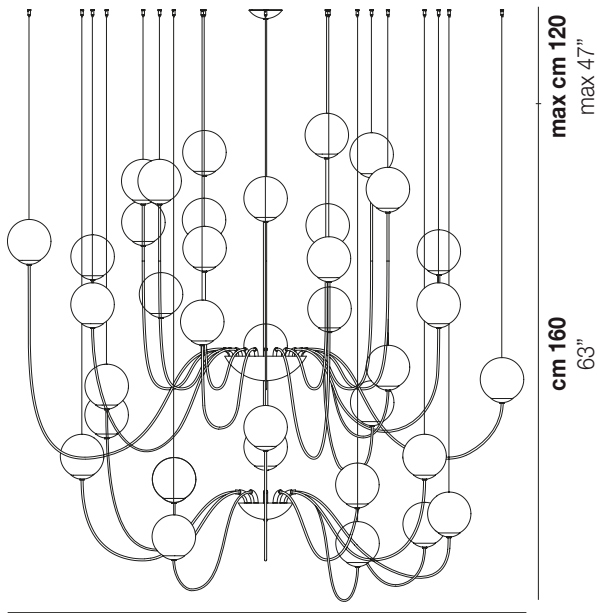

max cm 120  
 max 47"

cm 160  
 63"

ø cm min 150 - max 190  
 ø min 59" - max 75"

### TECHNICAL DATA:

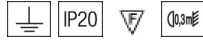

### CERTIFICATIONS:



### LIGHTING SOURCES

ALO → 36x20w 120V/60HZ G9

VOLUME Mc 0,42  
 GROSS WEIGHT Kg 0  
 NET WEIGHT Kg 0

download resources



### SHADE FINISHING

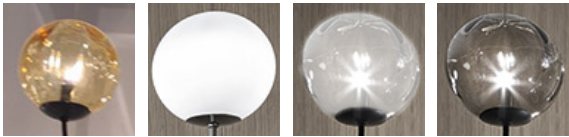

AM/TR

BC/SF

CR/TR

FU/TR

### FRAME FINISHING

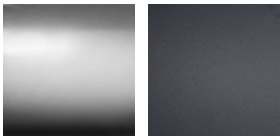

CR

NE

## OTHER AVAILABLE VERSIONS

Click on the version to go to the web version of the product

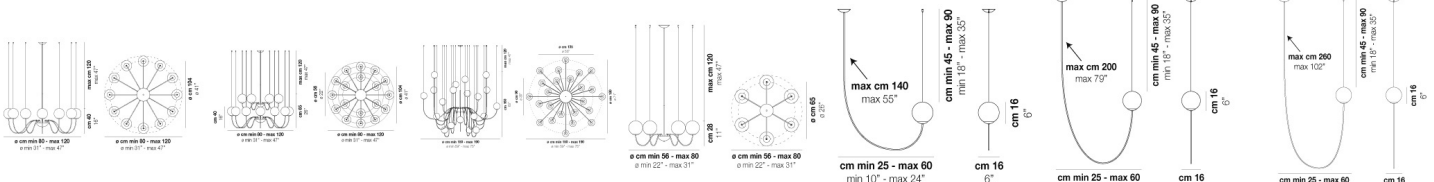

PUPPE SP 12 P

PUPPE SP 18 P

PUPPE SP 24 P

PUPPE SP 6 P

PUPPE SP D14P

PUPPE SP D20P

PUPPE SP D26P

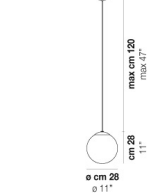
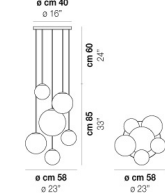
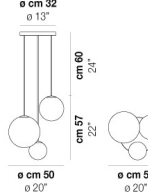
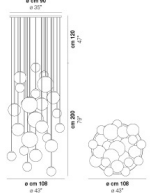
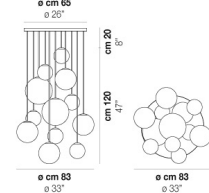
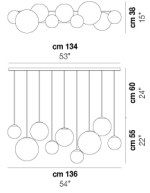
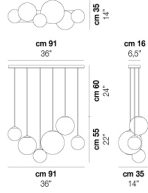

PUPPE SP L6

PUPPE SP L9

PUPPE SP R12

PUPPE SP R24

PUPPE SP R3

PUPPE SP R6

PUPPE SP G



PUPPE SP M

PUPPE SP P



## PUPPET SP D14 P

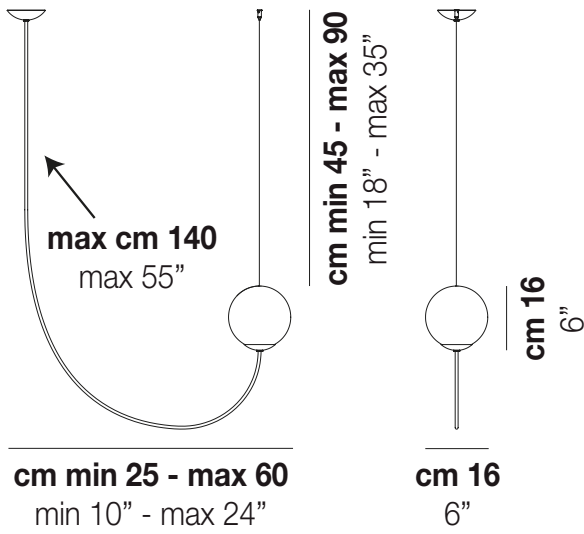

### TECHNICAL DATA:



### CERTIFICATIONS:



### LIGHTING SOURCES

ALO → 1x60w 120V/60HZ G9

VOLUME Mc 0  
GROSS WEIGHT Kg 0  
NET WEIGHT Kg 0

download resources



### SHADE FINISHING

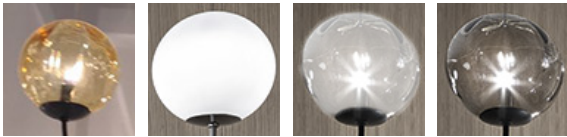

AM/TR

BC/SF

CR/TR

FU/TR

### FRAME FINISHING

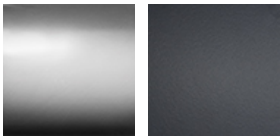

CR

NE

## OTHER AVAILABLE VERSIONS

Click on the version to go to the web version of the product

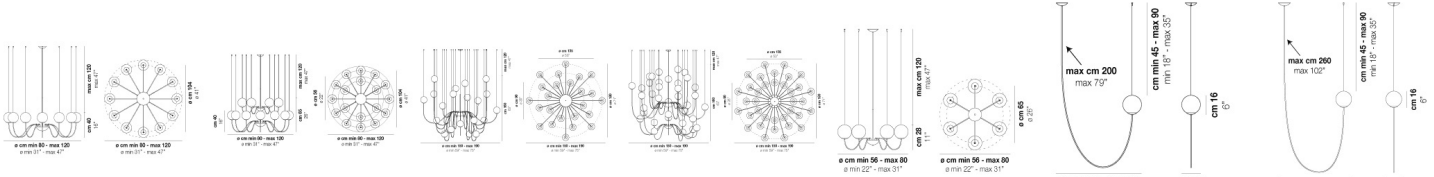

PUPPE SP 12 P

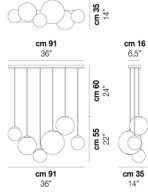

PUPPE SP 18 P

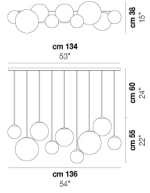

PUPPE SP 24 P

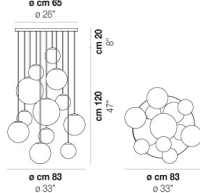

PUPPE SP 36 P

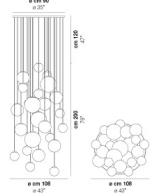

PUPPE SP 6 P

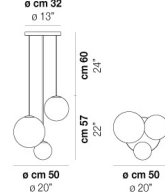

PUPPE SP D20P

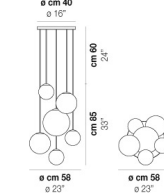

PUPPE SP D26P

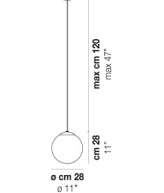

PUPPE SP L6



PUPPE SP L9



PUPPE SP R12



PUPPE SP R24



PUPPE SP R3



PUPPE SP R6



PUPPE SP G



PUPPE SP M



PUPPE SP P



## PUPPET SP D20 P

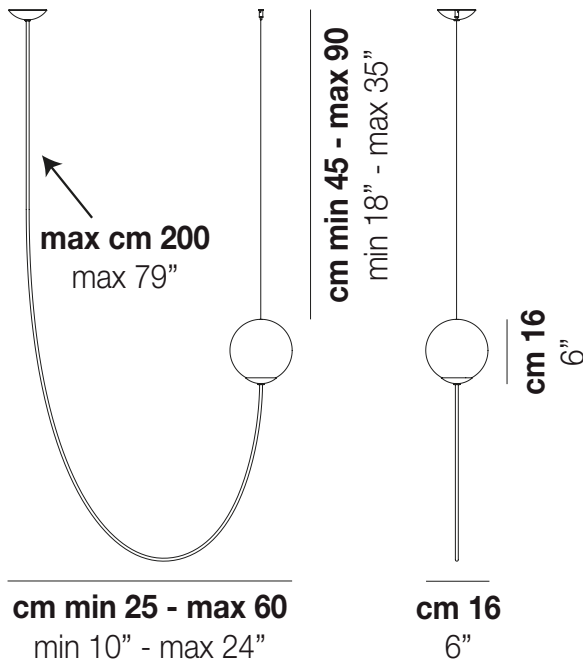

### TECHNICAL DATA:



### CERTIFICATIONS:



### LIGHTING SOURCES

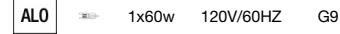

VOLUME Mc 0  
GROSS WEIGHT Kg 0  
NET WEIGHT Kg 0

download resources



### SHADE FINISHING



AM/TR

BC/SF

CR/TR

FU/TR

### FRAME FINISHING

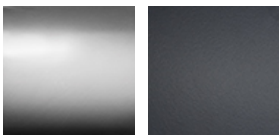

CR

NE

## OTHER AVAILABLE VERSIONS

Click on the version to go to the web version of the product

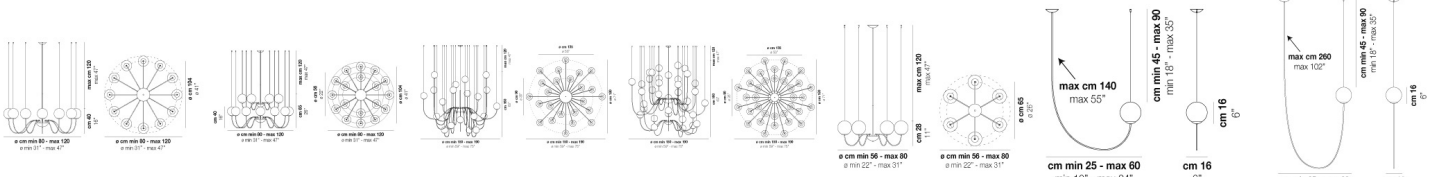

PUPPE SP 12 P

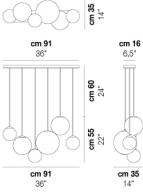

PUPPE SP 18 P

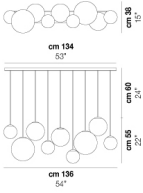

PUPPE SP 24 P

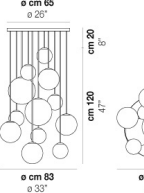

PUPPE SP 36 P

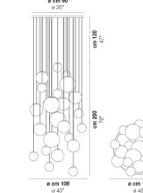

PUPPE SP 6 P

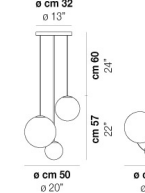

PUPPE SP D14P

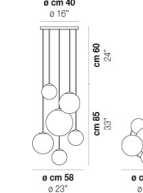

PUPPE SP D26P

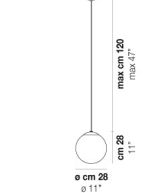

PUPPE SP L6

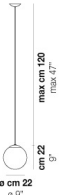

PUPPE SP L9



PUPPE SP R12



PUPPE SP R24



PUPPE SP R3



PUPPE SP R6



PUPPE SP G



PUPPE SP M



PUPPE SP P



## PUPPET SP D26 P

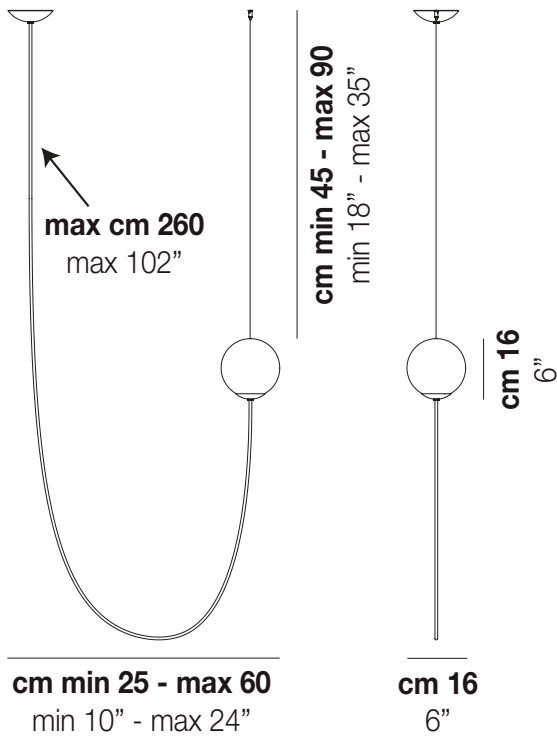

### TECHNICAL DATA:



### CERTIFICATIONS:



### LIGHTING SOURCES

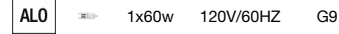

VOLUME Mc 0  
GROSS WEIGHT Kg 0  
NET WEIGHT Kg 0

download resources



### SHADE FINISHING

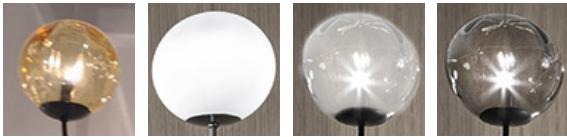

AM/TR

BC/SF

CR/TR

FU/TR

### FRAME FINISHING

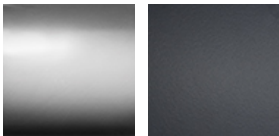

CR

NE



## PUPPET SP L6

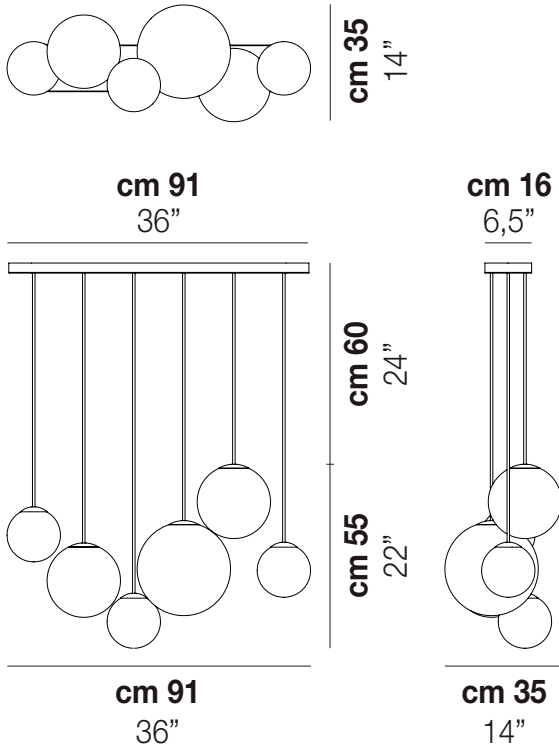

### TECHNICAL DATA:

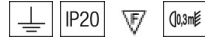

### CERTIFICATIONS:



### LIGHTING SOURCES

AL0 6x60w 120V/60HZ G9

VOLUME Mc 0  
 GROSS WEIGHT Kg 0  
 NET WEIGHT Kg 0

download resources



### SHADE FINISHING

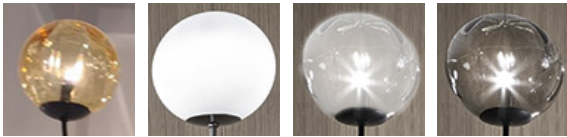

AM/TR BC/SF CR/TR FU/TR

### FRAME FINISHING

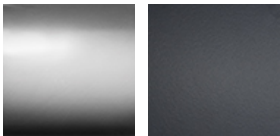

CR NE

## OTHER AVAILABLE VERSIONS

Click on the version to go to the web version of the product

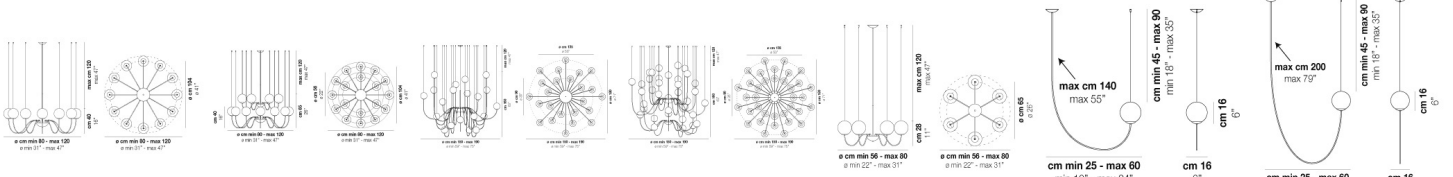

PUPPE SP 12 P

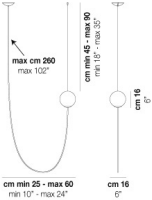

PUPPE SP 18 P

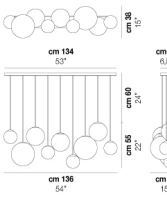

PUPPE SP 24 P

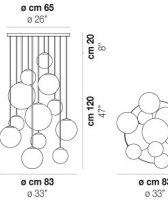

PUPPE SP 36 P

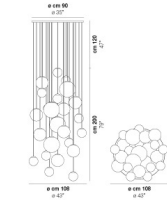

PUPPE SP 6 P

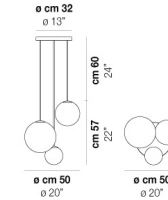

PUPPE SP D14P

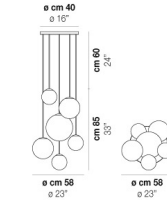

PUPPE SP D20P

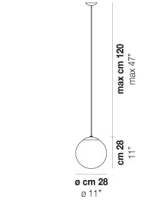

PUPPE SP D26P

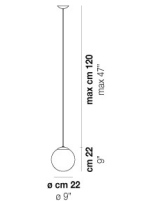

PUPPE SP L9

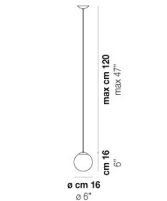

PUPPE SP R12

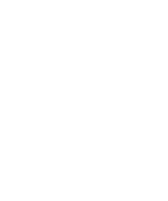

PUPPE SP R24



PUPPE SP R3



PUPPE SP R6



PUPPE SP G

PUPPE SP M



PUPPE SP P





## PUPPET SP L9

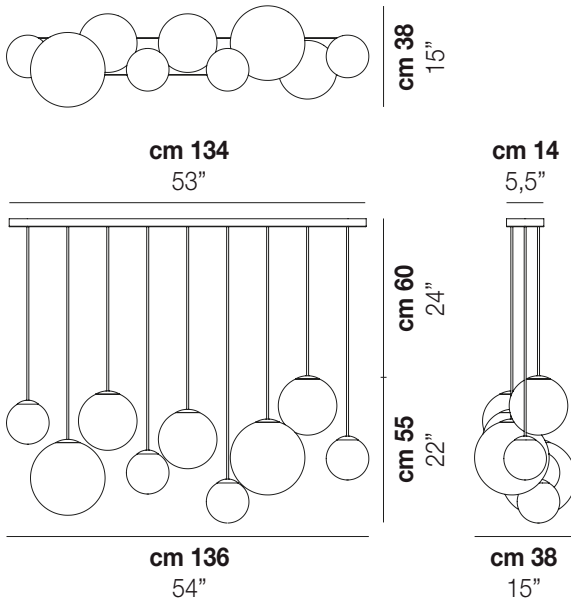

### TECHNICAL DATA:



### CERTIFICATIONS:



### LIGHTING SOURCES

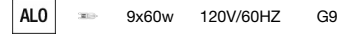

VOLUME Mc 0,41  
 GROSS WEIGHT Kg 33  
 NET WEIGHT Kg 20

download resources



### SHADE FINISHING



AM/TR BC/SF CR/TR FU/TR

### FRAME FINISHING

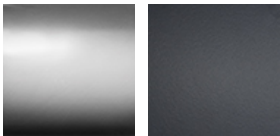

CR NE

## OTHER AVAILABLE VERSIONS

Click on the version to go to the web version of the product

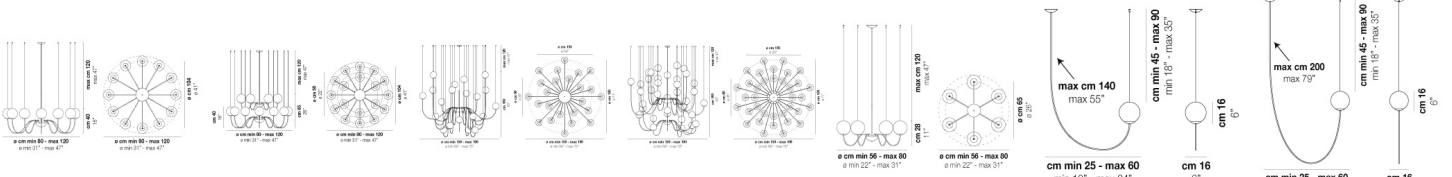

PUPPE SP 12 P

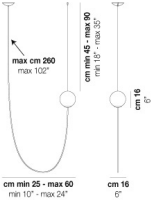

PUPPE SP 18 P

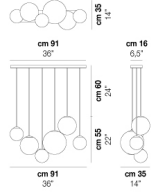

PUPPE SP 24 P

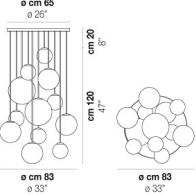

PUPPE SP 36 P

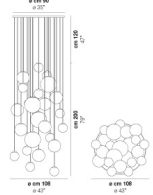

PUPPE SP 6 P

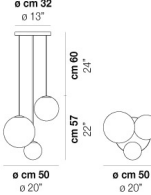

PUPPE SP D14P

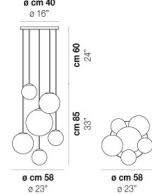

PUPPE SP D20P

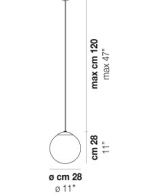

PUPPE SP D26P



PUPPE SP L6



PUPPE SP R12

PUPPE SP R24

PUPPE SP R3

PUPPE SP R6

PUPPE SP G

PUPPE SP M

PUPPE SP P

## PUPPET SP R3

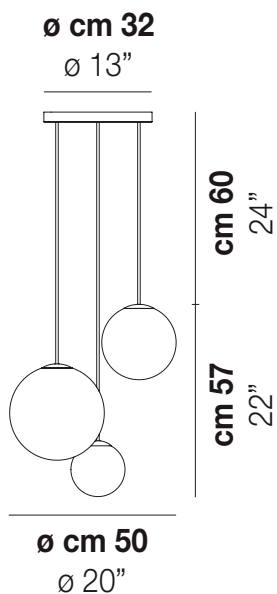

### TECHNICAL DATA:

### CERTIFICATIONS:



### LIGHTING SOURCES

AL0 3x60w 120V/60HZ G9

VOLUME Mc 0,2  
 GROSS WEIGHT Kg 0  
 NET WEIGHT Kg 0

download resources



### SHADE FINISHING



AM/TR

BC/SF

CR/TR

FU/TR

### FRAME FINISHING

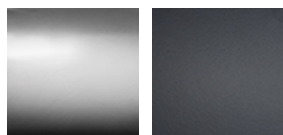

CR

NE

## OTHER AVAILABLE VERSIONS

Click on the version to go to the web version of the product

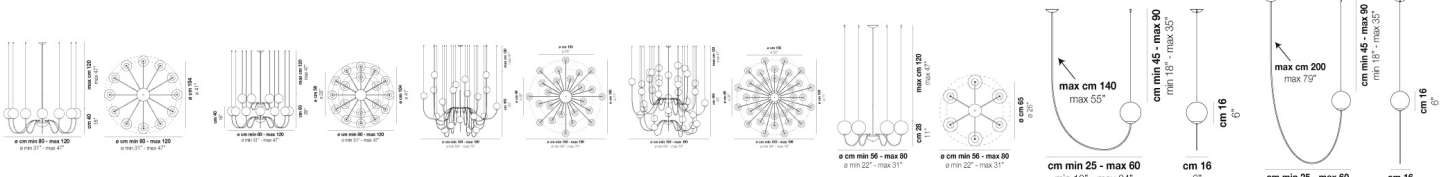

PUPPE SP 12 P

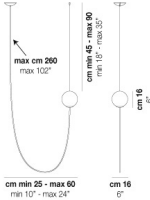

PUPPE SP 18 P

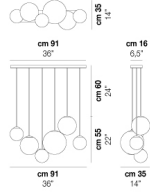

PUPPE SP 24 P

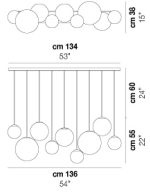

PUPPE SP 36 P

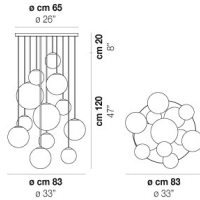

PUPPE SP 6 P

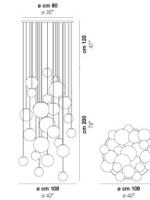

PUPPE SP D14P

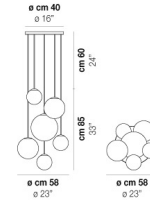

PUPPE SP D20P

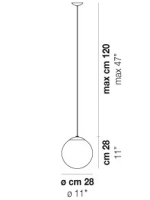

PUPPE SP D26P



PUPPE SP L6



PUPPE SP L9



PUPPE SP R12



PUPPE SP R24



PUPPE SP R6



PUPPE SP G



PUPPE SP M



PUPPE SP P



## PUPPET SP R6

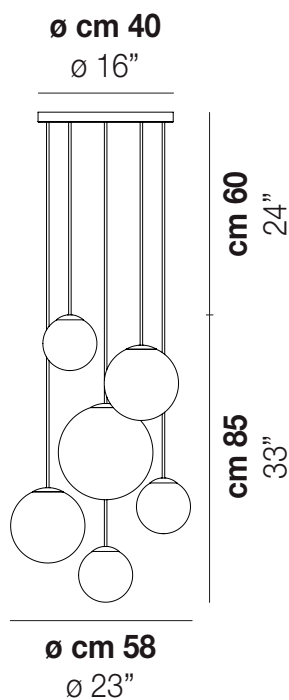

### TECHNICAL DATA:

### CERTIFICATIONS:



### LIGHTING SOURCES

AL0 6x60w 120V/60HZ G9

VOLUME Mc 0,08  
 GROSS WEIGHT Kg 0  
 NET WEIGHT Kg 0

download resources



### SHADE FINISHING



AM/TR

BC/SF

CR/TR

FU/TR

### FRAME FINISHING

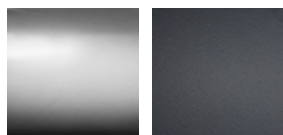

CR

NE

## OTHER AVAILABLE VERSIONS

Click on the version to go to the web version of the product

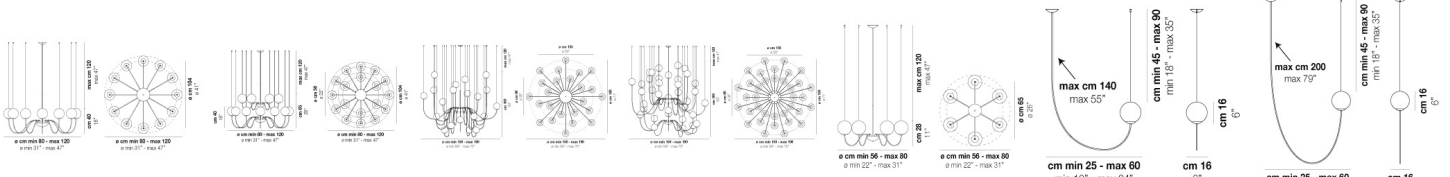

PUPPE SP 12 P

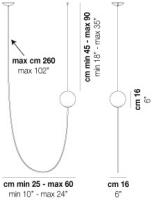

PUPPE SP 18 P

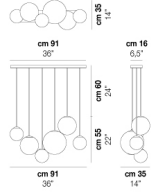

PUPPE SP 24 P

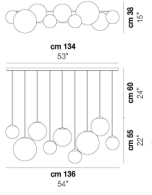

PUPPE SP 36 P

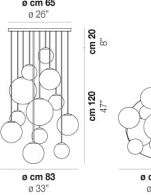

PUPPE SP 6 P

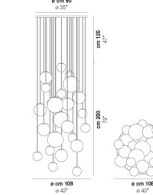

PUPPE SP D14P

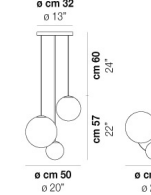

PUPPE SP D20P

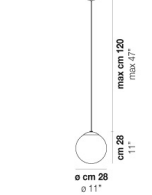

PUPPE SP D26P

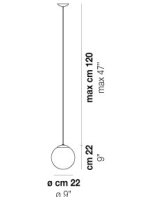

PUPPE SP L6

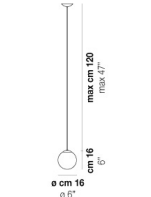

PUPPE SP L9



PUPPE SP R12



PUPPE SP R24



PUPPE SP R3



PUPPE SP G

PUPPE SP M



PUPPE SP P

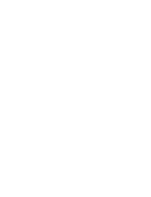

## PUPPET SP R12

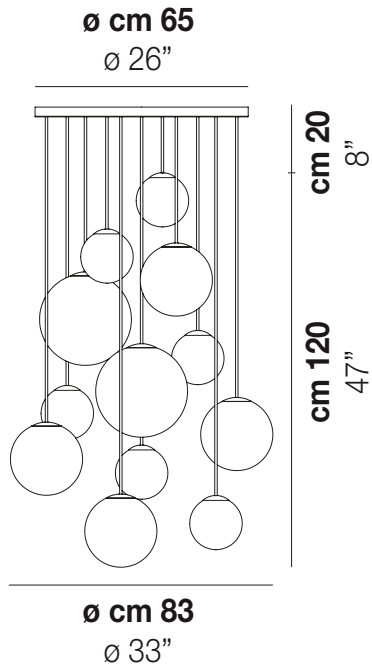

### TECHNICAL DATA:

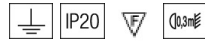

### CERTIFICATIONS:



### LIGHTING SOURCES

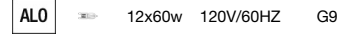

VOLUME Mc 0  
 GROSS WEIGHT Kg 0  
 NET WEIGHT Kg 0

download resources



### SHADE FINISHING

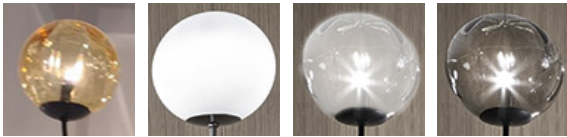

AM/TR

BC/SF

CR/TR

FU/TR

### FRAME FINISHING

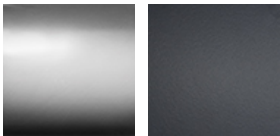

CR

NE

## OTHER AVAILABLE VERSIONS

Click on the version to go to the web version of the product

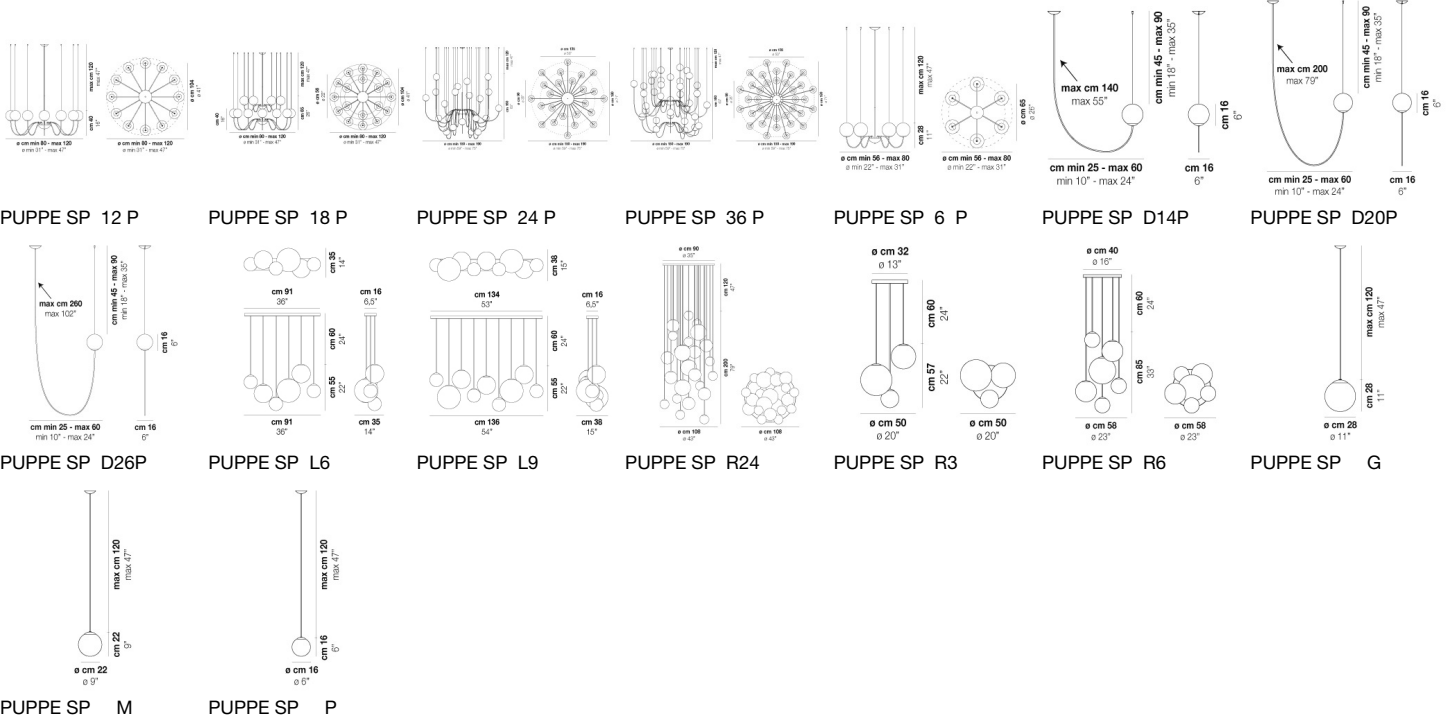



## PUPPET SP R24

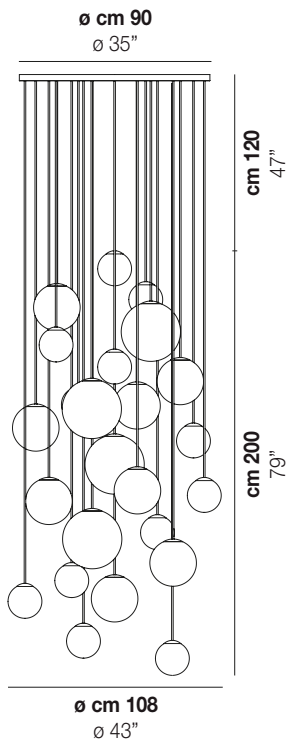

### TECHNICAL DATA:



### CERTIFICATIONS:



### LIGHTING SOURCES

AL0 24x25w 120V/60HZ G9

VOLUME Mc 0

GROSS WEIGHT Kg 0

NET WEIGHT Kg 0

download resources



### SHADE FINISHING

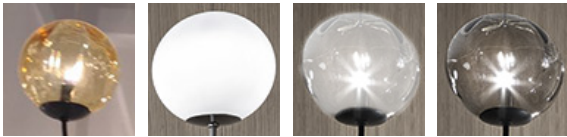

AM/TR

BC/SF

CR/TR

FU/TR

### FRAME FINISHING

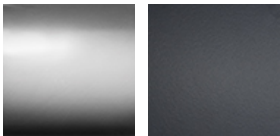

CR

NE

## OTHER AVAILABLE VERSIONS

Click on the version to go to the web version of the product

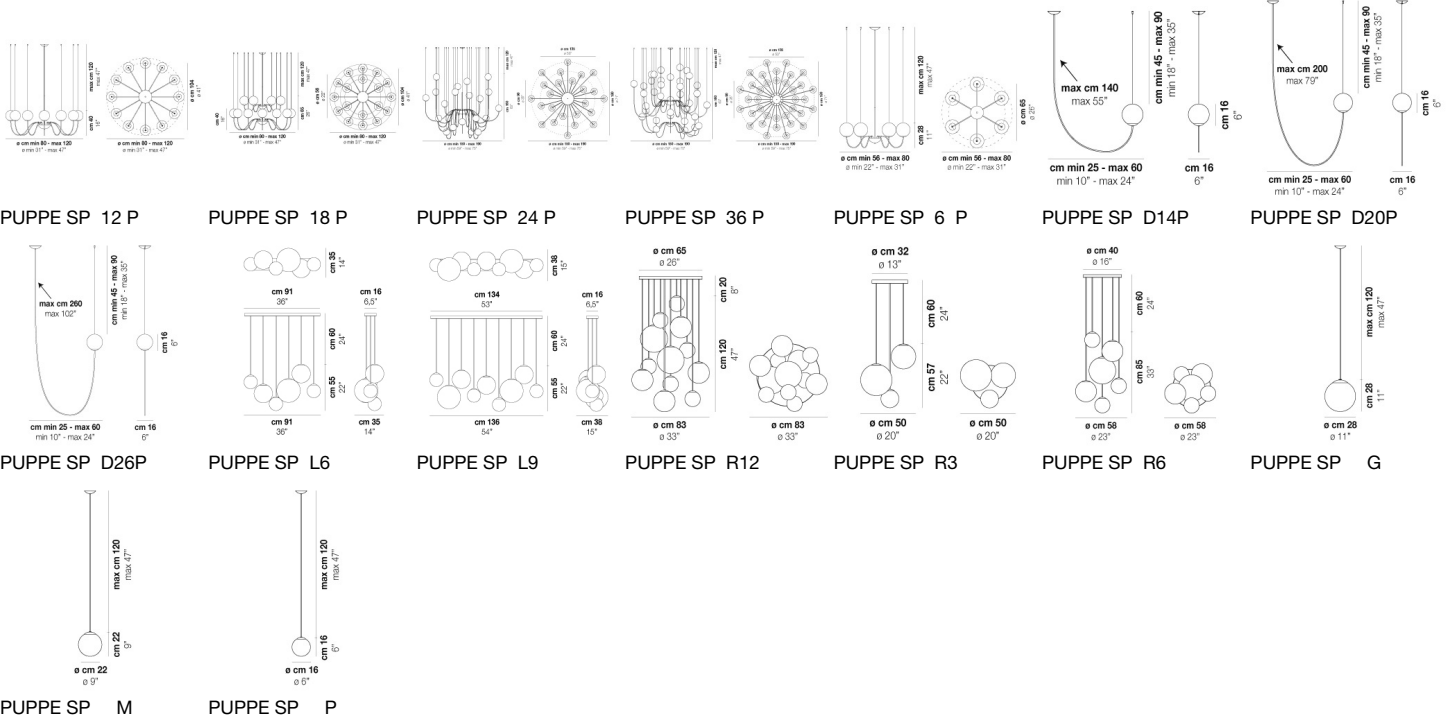

**INSTRUCCIONES DE MONTAJE**

Asegurarse de que el aparato no esté conectado a la corriente antes de proceder a su montaje.

- Desatornillar el componente (1) de la cubierta (2) y fijado al techo (6) del soporte (3) a través de los tornillos (4) y bloques (5).
- Pasar el cable (7) a través del dosel (2) y el componente (8). Asegure que el sujetar y finalmente conectar al terminal (9).
- Conecte los cables de la red a los terminales (9) asegurándose de insertar el cable amarillo / verde en el terminal marcado con el símbolo de tierra.
- Cierre la cubierta (2) y el tornillo del componente (1).
- Inserte las bombillas en el soporte de la lámpara (10).
- Localiza puntos de montaje de techo a base de puntos de luz y las cuotas de referencia, componentes fijos seguidos (11) con tornillos autorroscantes y fischer adecuada, siguiendo las instrucciones en orden alfabético como se muestra.
- Insertar en los cables de acero (12) los componentes (13) en el lado de la cabeza (14).
- Pase el cable de acero a través de un vidrio (15) y mantenerlo suspendido. Inserte el cable de acero en particular, de techo (16) siguiendo los pasos.
- Aflojar lo particular (A) Inserte el cable de acero (B) a través y fuera del agujero lado del cilindro (C), usando una herramienta del agujero opuesto (D). Después de establecer la altura deseada del vidrio, atornillar el componente (A) por lo que el cable cuelgue del mecanismo de cierre automático. Si desea ajustar la altura del cable simplemente interactuar de nuevo detalle (A). Finalmente cortó el cable de acero en exceso derramado desde el orificio (C).
- Insertar el marco de cerradura con bombillo (17) dentro de un vaso (18) y atornillar al bastidor. Tenga cuidado de no girar el marco de no torcer el cable de alimentación.
- Repita el procedimiento desde el paso (10) hasta aquí, por cada vaso hasta que el resultado final (19).



Vetreria Vistosi Srl · Via G. Galilei, 9-9/A-11 · 31021 Mogliano V.to · Treviso · Italy  
P. Iva IT02497840278 · Cap. Soc. € 100.000,00 I.V. · N° R.E.A. TV · 170728  
Cod. Fisc. - P.I. N° 01808840266 · Iscr. Reg. AEE N° IT08010000000170  
Tel. +39 041 5900170 - 041 5903480 · Fax +39 041 5900992 - 041 5904540  
vetreriavistosi@legalmail.it · www.vistosi.it · vistosi@vistosi.it

**Vistosi**

**English****ASSEMBLY INSTRUCTION**

Check there is no network voltage before installing the equipment.

- Unscrew the component (1) from the canopy (2) and fixed to the ceiling (6) the bracket (3) through the screws (4) and blocks (5).
- Pass the cable (7) through the canopy (2) and the component (8). Secure it on clamp and finally connect to terminal (9).
- Connect the network cables to the terminals (9) making sure to insert the yellow / green in the terminal marked by the earth symbol.
- Close the canopy (2) and screw the component (1).
- Insert the bulbs in the lamp holder (10).
- Locate ceiling mounting points based on points light and quotas reference, followed fix components (11) with self-tapping screws and fischer adequate, following the instructions in alphabetical order as shown.
- Insert in the steel cables (12) components (13) on the side of the head (14).
- Pass the steel cable through a glass (15) and keep it suspended.
- Insert the steel cable in particular ceiling (16) by following steps.
- Unscrew the particular (A) Insert the steel cable (B) through and out of the hole side of the cylinder (C), using a tool from the opposite hole (D). After establishing the desired height of the glass, screw the component (A) so the cord will hang from the self-locking mechanism. If you wish to adjust the height of the cable simply interact on again detail (A). Finally cut the steel cable in excess spilled from the hole (C).
- Insert the lock frame with bulb (17) inside a glass (18) and screw down to the frame. Be careful not to turn the frame to you do not twist the power cord.
- Repeat the procedure from step (10) up to here, for each glass until the end result (19).

**Italiano****ISTRUZIONI PER IL MONTAGGIO**

Assicurarsi che non sia presente tensione di rete prima di procedere all'installazione dell'apparecchio.

- Svitare il componente (1) dal rosone (2) e fissare a soffitto (6) la staffa (3) tramite le apposite viti (4) e tasselli (5).
- Passare il cavo (7) attraverso il rosone (2) e il componente (8). Fissarlo sul bloccacavo ed infine collegarli al morsetto (9).
- Collegare i cavi di rete ai morsetti (9) facendo attenzione di inserire il cavo giallo/verde nel morsetto contrassegnato dal simbolo di terra.
- Richiudere il rosone (2) e avvitare il componente (1).
- Inserire le lampadine nei portalampade (10).
- Stabilire innanzitutto a soffitto i punti di fissaggio in base ai punti luce e alle quote di ingombro, a seguire fissare i componenti (11) con fischer e viti autofilettanti adeguate, seguendo le operazioni in ordine alfabetico come illustrato.
- Infilare nei cavi di acciaio (12) i componenti (13) dalla parte della testa (14).
- Far passare il cavo di acciaio attraverso un vetro (15) e tenerlo sospeso.
- Inserire il cavo di acciaio nel particolare a soffitto (16) seguendo i passaggi.
- Svitare il particolare (A) infilare il cavo di acciaio (B) attraverso e farlo uscire dal foro laterale del cilindro (C), aiutandosi con un utensile dal foro opposto (D). Una volta stabilita l'altezza desiderata del vetro, riavvitare il componente (A) così il cavo si bloccherà dal meccanismo di autobloccaggio. Qualora si volesse correggere l'altezza del cavo basterà interagire nuovamente sul particolare (A). Infine tagliare il cavo di acciaio in eccesso fuoriuscito dal foro (C).
- Inserire il blocco montatura con lampadina (17) all'interno di un vetro (18) ed avvitare quest'ultimo alla montatura. Attenzione a non far girare la montatura per far sì di non attorcigliare il cavo elettrico.
- Ripetere le procedure dal punto (10) fino a qui, per ogni vetro fino ad ottenere il risultato finale (19).

## EINBAUANLEITUNG

Stellen Sie sicher, dass es keine Netzspannung vor der Installation des Gerätes.

- Die Komponente (1) Lösen von der Segelfläche (2) und fixiert an der Decke (6) der Bügel (3) durch die Schrauben (4) und die Blöcke (5).
- Führen Sie das Kabel (7) durch die Baumkronen (2) und dem Bauteil (8). Sichern Sie sie auf Klemmen und schließlich eine Verbindung zum Endgerät (9).
- Verbinden Sie die Netzkabel an den Anschlüssen (9) und achten Sie auf das gelbe Kabel einfügen / Grün in der Klemme von der Erde Symbol gekennzeichnet.
- Schließen Sie die Haube (2) und schrauben Sie die Komponente (1).
- Setzen Sie die Zwiebeln in den Lampenhalter (10).
- Finde Deckenmontage Punkten basierend auf Lichtpunkte und Quoten Bezugs gefolgt Fix-Komponenten (11) mit selbstschneidenden Schrauben und Fischer angemessen, gemäß den Anweisungen in alphabetischer Reihenfolge, wie dargestellt.
- Einfügen in den Stahlseilen (12) Komponenten (13) auf der Seite des Kopfes (14).
- Übergeben Sie das Stahlseil durch ein Glas (15) und halten Sie sie suspendiert.
- Legen Sie die Stahlkabel insbesondere Decke (16) durch folgende Schritte.
- Schrauben Sie die insbesondere (A) Legen Sie die Stahlkabel (B) durch und aus dem Loch Seite des Zylinders (C), mit einem Werkzeug von der gegenüberliegenden Bohrung (D).  
Nach der Gründung der gewünschten Höhe des Glases, schrauben Sie die Komponente (A) so dass die Schnur aus dem selbsthemmenden Mechanismus hängen.  
Wenn Sie die Höhe des Kabel einstellen möchten einfach interagieren wieder Detail (A).  
Schließlich schnitt das Stahlseil über verschüttet aus dem Loch (C).
- Stecken Sie das Schloss-Rahmen mit Glühlampe (17) in einem Glas (18) und schrauben auf den Rahmen. Achten Sie darauf, um den Rahmen zu drehen Sie nicht verdrehen Sie das Netzkabel.
- Wiederholen Sie den Vorgang ab Schritt (10), bis hierher, für jedes Glas, bis die Ergebnis (19).

## INSTRUCTIONS POUR L'INSTALLATION

Avant de procéder à l'installation de l'appareil s'assurer qu'il n'y ait pas de tension de réseau.

- Dévisser le composant (1) de la voilure (2) et fixée au plafond (6) du support (3) par l'intermédiaire les vis (4) et les blocs (5).
- Faire passer le câble (7) à travers la voûte (2) et le composant (8). Fixez-le sur serrer et finalement se connecter à la borne (9).
- Branchez les câbles de réseau aux bornes (9) en veillant à insérer le câble jaune / vert dans la borne marquée par le symbole de terre.
- Fermez la canopée (2) et visser le composant (1).
- Insérer les ampoules dans le support de lampe (10).
- Localiser les points de montage de plafond en fonction des points de lumière et quotas référence, des composants fix suivi (11) avec des vis et Fischer autotaraudeuses adéquate, suivant les instructions dans l'ordre alphabétique, comme indiqué.
- Insérer dans les câbles en acier (12) de composants (13) sur le côté de la tête (14).
- Passez le câble d'acier à travers un verre (15) et la maintenir en suspension.
- Insérez le câble d'acier, en particulier le plafond (16) en suivant les étapes.
- Dévissez le particulier (A) Insérez le câble d'acier (B) à travers et hors du trou côté du cylindre (C), en utilisant un outil à partir de l'orifice opposé (D).  
Après avoir établi la hauteur désirée de la vitre, vis du composant (A) de sorte que le cordon sera suspendu à partir du mécanisme auto-bloquant.  
Si vous souhaitez régler la hauteur du câble interagir simplement à nouveau détail (A).  
Enfin couper le câble d'acier en excès déversé du trou (C).
- Insérez le cadre de verrouillage avec ampoule (17) à l'intérieur d'un verre (18) et visser au châssis. Veillez à ne pas éteindre le cadre de vous ne pas tordre le cordon d'alimentation.
- Répétez la procédure de l'étape (10) jusque-là, pour chaque verre jusqu'à ce que le résultat d'extrémité (19).

## ΟΔΗΓΙΕΣ ΕΓΚΑΤΑΣΤΑΣΗΣ

Βεβαιωθείτε ότι δεν υπάρχει τάση ρεύματος πριν από την εγκατάσταση της μονάδας.

- Ξεβιδώστε το εξάρτημα (1) από το θόλο (2) και στερεώνεται στην οροφή (6) το στήριγμα (3) μέσω της τις βίδες (4) και μπλοκ (5).
- Περάστε το καλώδιο (7) μέσα από την τέντα (2) και το συστατικό (8).
- Στερεώστε το στο σφικκτήρα και, τέλος, σύνδεση με ακροδέκτη (9). Συνδέστε τα καλώδια του δικτύου στα τερματικά (9) φροντίζοντας να τοποθετήσετε το κίτρινο καλώδιο / πράσινο στο τερματικό που σημειώνονται με το σύμβολο της γης.  
Κλείστε το θόλο (2) και βιδώστε το εξάρτημα (1).
- Τοποθετήστε τους βολβούς στο ντουί (10).  
Εντοπίστε σημεία στήριξης οροφής με βάση τα σημεία φωτός και των ποσοστώσεων αναφοράς, που ακολουθείται συστατικά fix (11) με λαμαρινόβιδες και Fischer επαρκή, ακολουθώντας τις οδηγίες σε αλφαβητική σειρά όπως φαίνεται.  
Τοποθετήστε στα καλώδια από χάλυβα (12) συστατικά (13) στην πλευρά της κεφαλής (14).  
Περάστε το συρματόσχοινο μέσα από ένα γυαλί (15) και κρατήστε το ανασταλεί. Τοποθετήστε το συρματόσχοινο ιδίως οροφής (16), ακολουθώντας τα βήματα.  
Ξεβιδώστε το συγκεκριμένο (A) Τοποθετήστε το συρματόσχοινο (B), μέσω και έξω από την τρύπα πλευρά του κυλίνδρου (C), χρησιμοποιώντας ένα εργαλείο από την αντίθετη οπή (D).  
Μετά τον καθορισμό το επιθυμητό ύψος του γυαλιού, βιδώστε το συστατικό (A) έτσι ώστε το καλώδιο να κρέμεται από την αυτο-μηχανισμό κλειδώματος. Εάν θέλετε να ρυθμίσετε το ύψος του καλωδίου απλά αλληλεπιδρούν ξανά λεπτομέρεια (A).  
Τέλος κόψτε το συρματόσχοινο πάνω διέρρευσε από την τρύπα (C).  
Εισάγετε την κλειδαριά πλαίσιο με λαμπτήρα (17) μέσα σε ένα ποτήρι (18) και βίδα προς τα κάτω στο πλαίσιο. Να είστε προσεκτικοί για να μην γυρίσει το πλαίσιο για να μην στρίβετε το καλώδιο τροφοδοσίας.  
Επαναλάβετε τη διαδικασία από το βήμα (10) έως εδώ, για κάθε ποτήρι μέχρι το τελικό αποτέλεσμα (19).

## ИНСТРУКЦИЯ ПО УСТАНОВКЕ

Убедитесь, что нет никакого напряжения сети перед установкой устройства.

- Отвинтите компонент (1) от навеса (2) и крепится к потолку (6) кронштейн (3), через винты (4) и блоки (5).
- Провести кабель (7) через навес (2) и компонента (8). Закрепите его на зажим и, наконец, подключить к терминалу (9).  
Подключите сетевые кабели к клеммам (9), убедившись, чтобы вставить желтый кабель / зеленый клемме символом заземления.
- Закройте купол (2) и винт компонент (1).  
Вставьте лампочки в патрон (10).
- Найдите потолочные точки крепления, основанные на точках света и квот с указанием, компоненты FIX (11) с помощью саморезов и Фишер адекватным, следуя инструкциям в алфавитном порядке, как показано на рисунке. Вставка в стальных тросов (12) Компоненты (13) на стороне головы (14).  
Пропустите кабель через стальную стекла (15) и держать его приостановлено. Вставьте стальной трос в частности потолка (16) следующими шагами.  
Отвинтите особое (A) Вставьте стальной трос (B) через и из отверстия стороне цилиндра (C), с помощью инструмента с противоположной отверстию (D). После установления желаемой высоты стекла, винт компонента (A) поэтому шнур будет висеть от самоблокирующимся механизмом. Если вы хотите, чтобы регулировать высоту кабеля просто взаимодействовать снова Деталь (A).  
Наконец сократить стальной трос сверх пролил из отверстия (C). Вставьте стопорное кадр с лампочкой (17) внутри стекла (18) и винт вниз к раме. Будьте осторожны, чтобы не превратить кадр Вы не крутить кабель питания.  
Повторите процедуру, начиная с шага (10) до сюда, для каждого стекла до вступления в Конечным результатом (19).

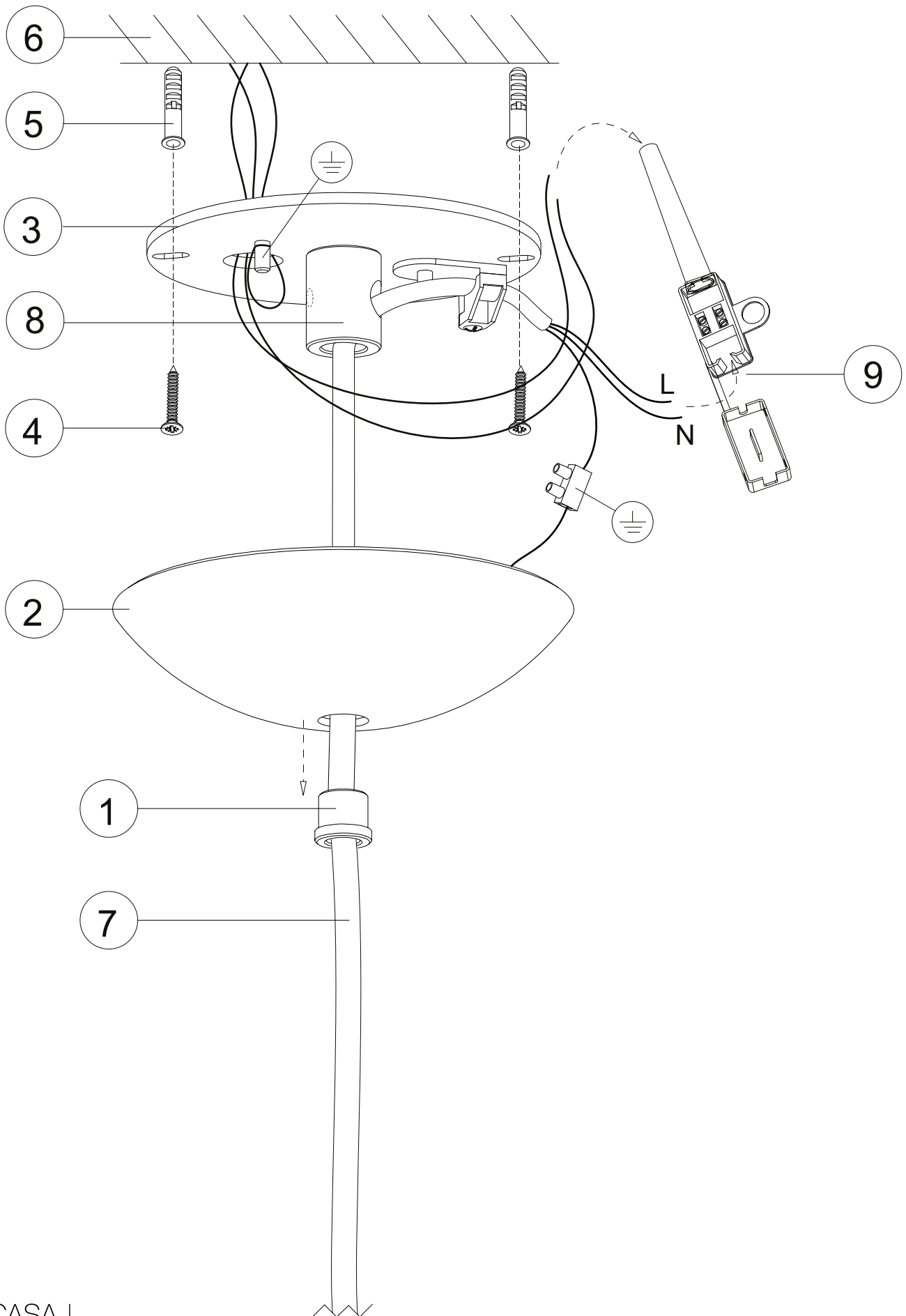

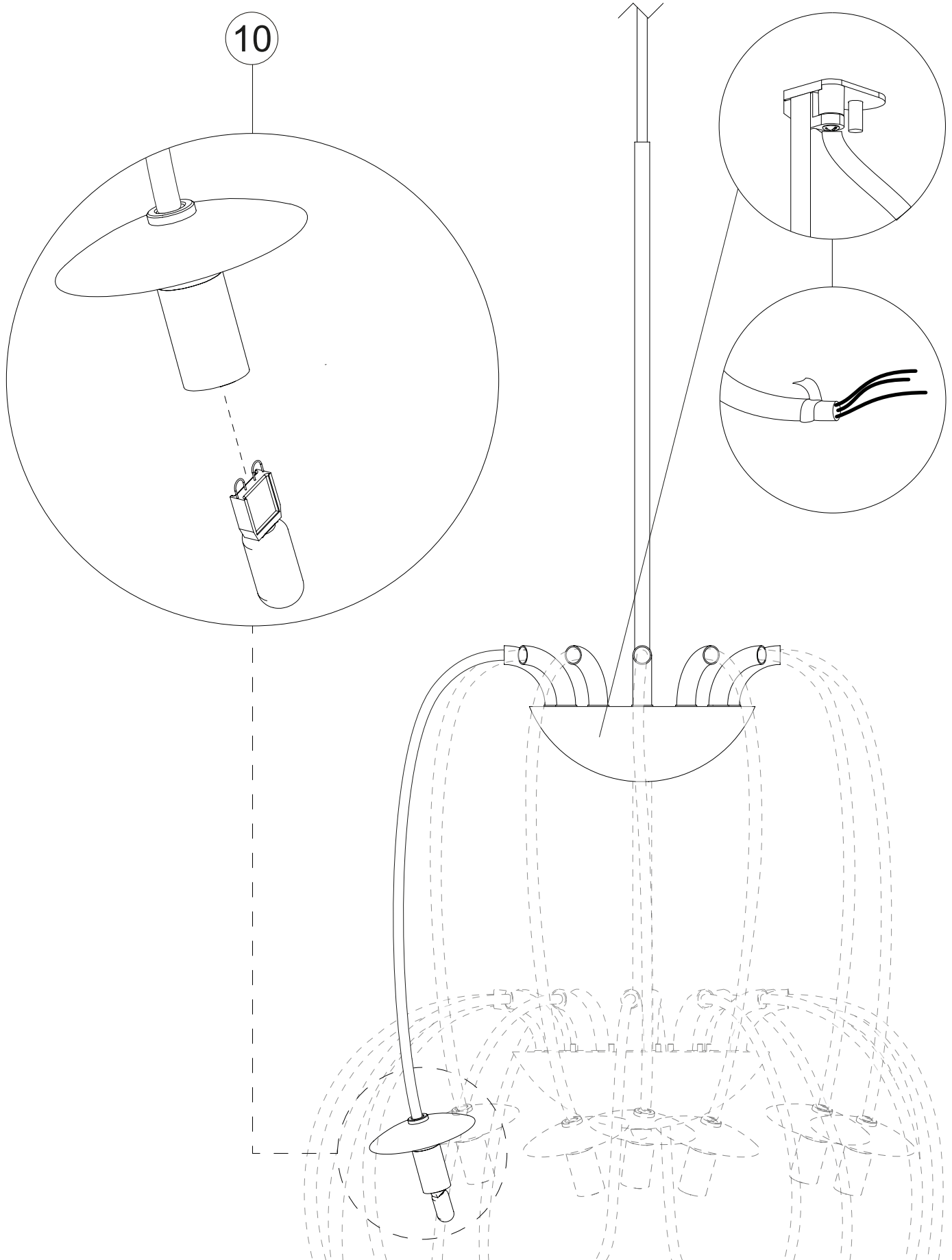

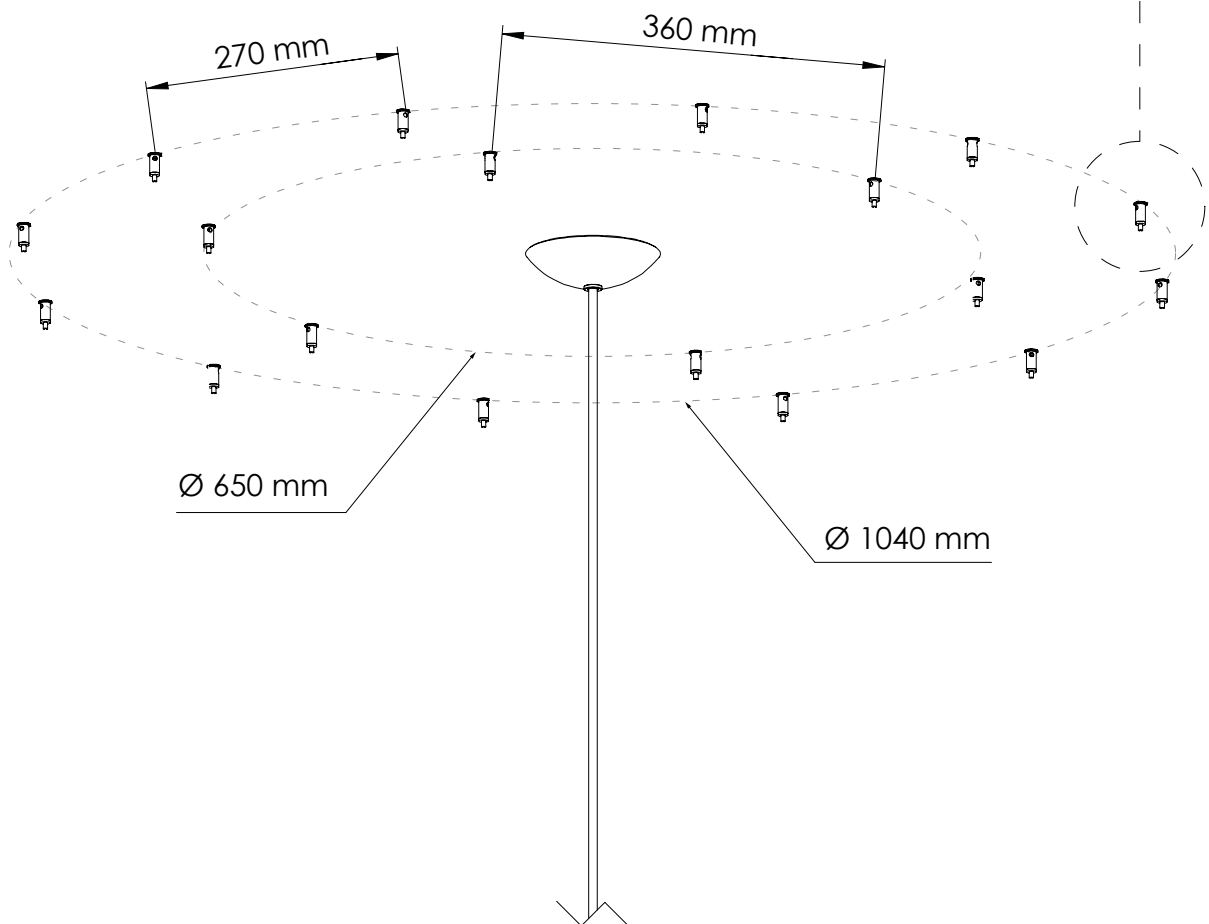
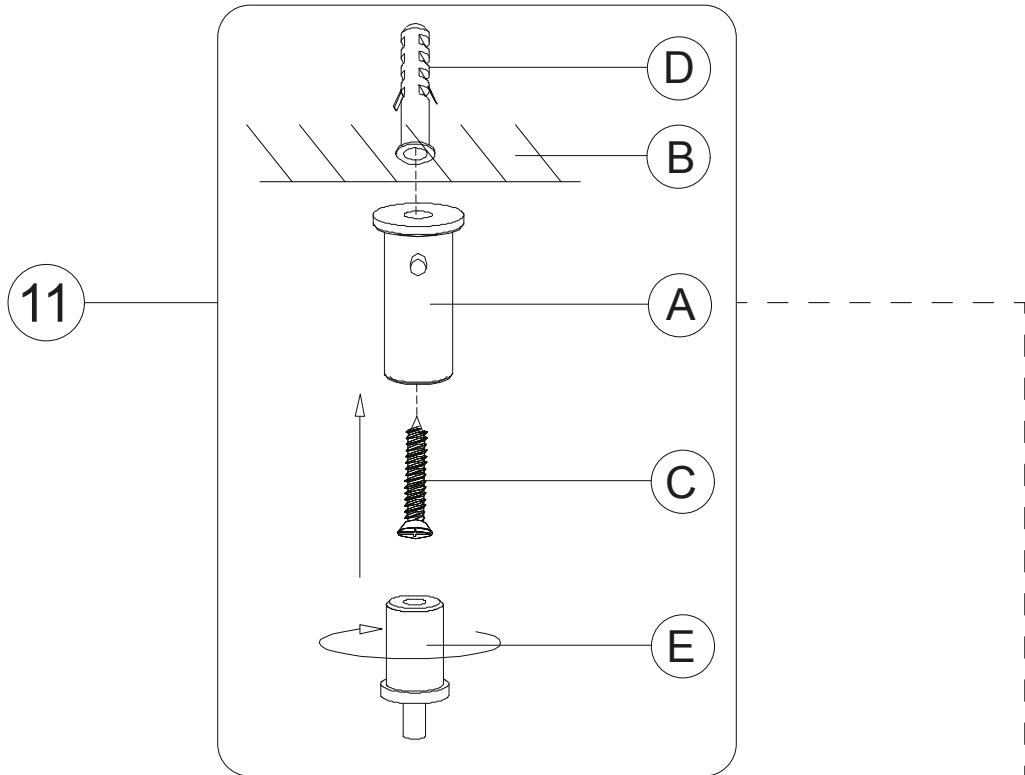

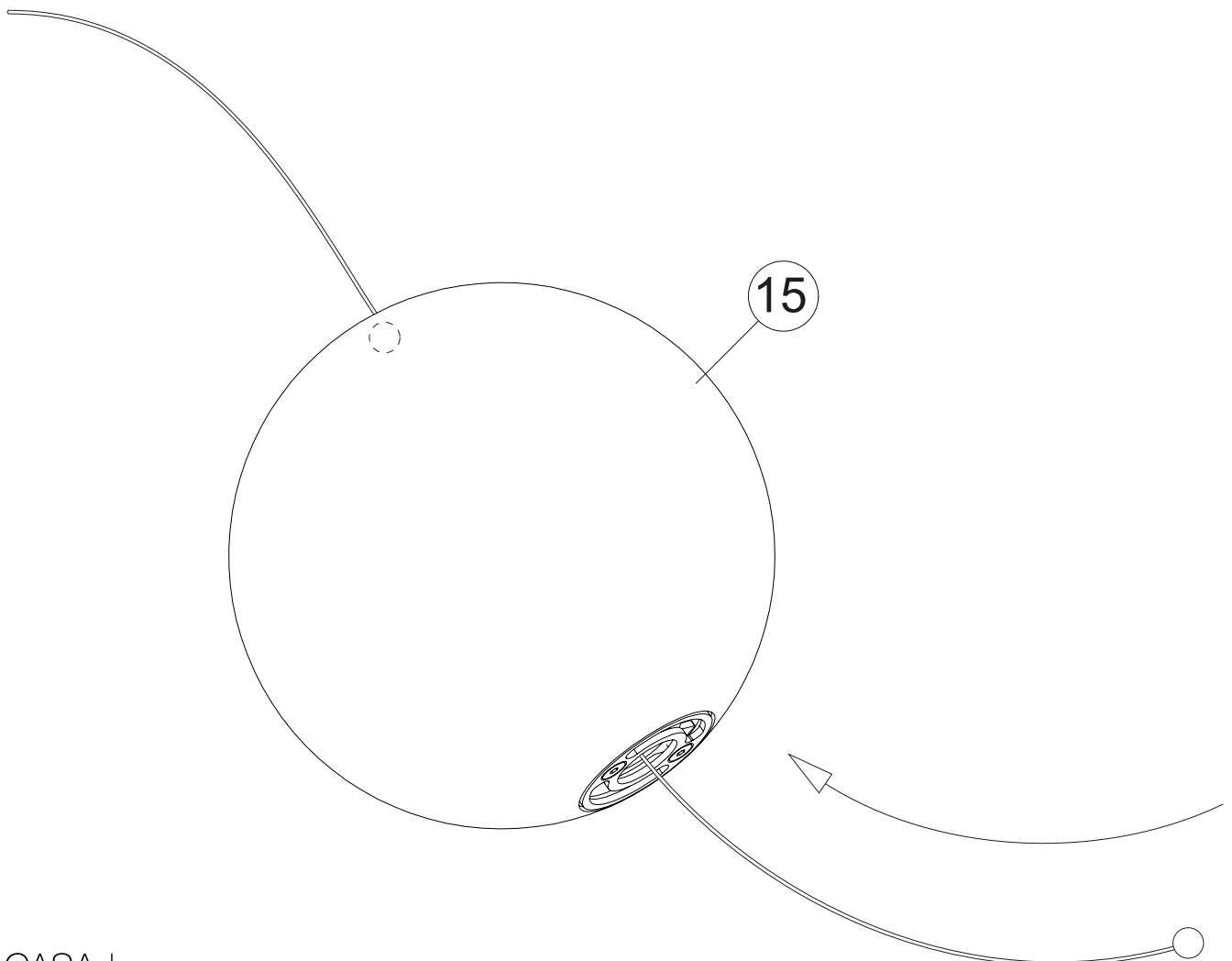
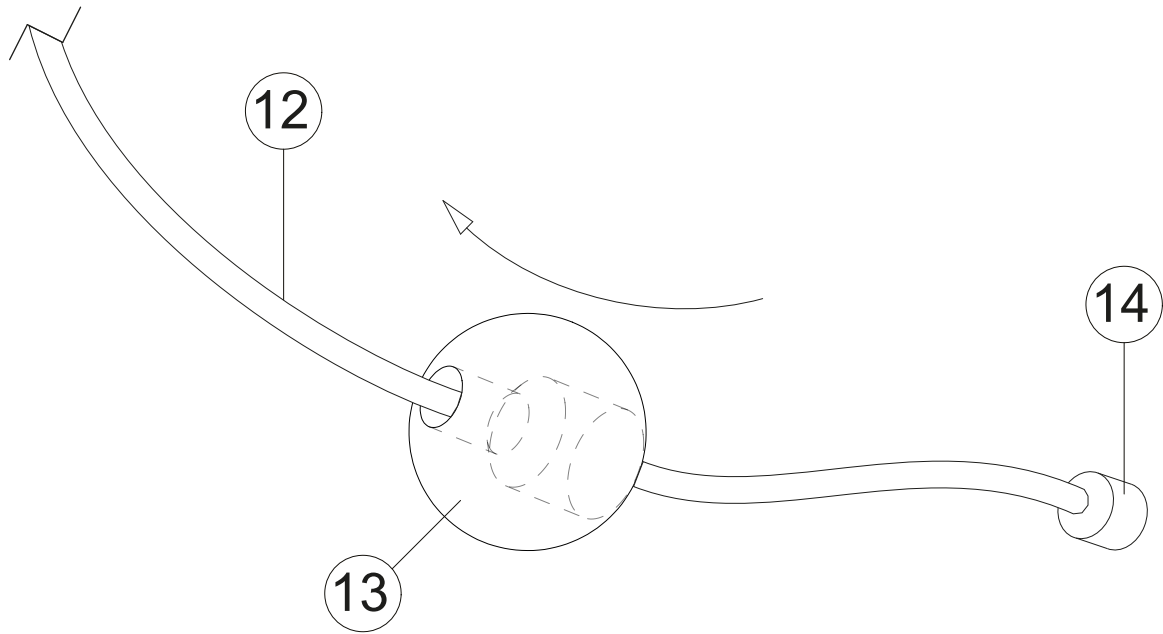



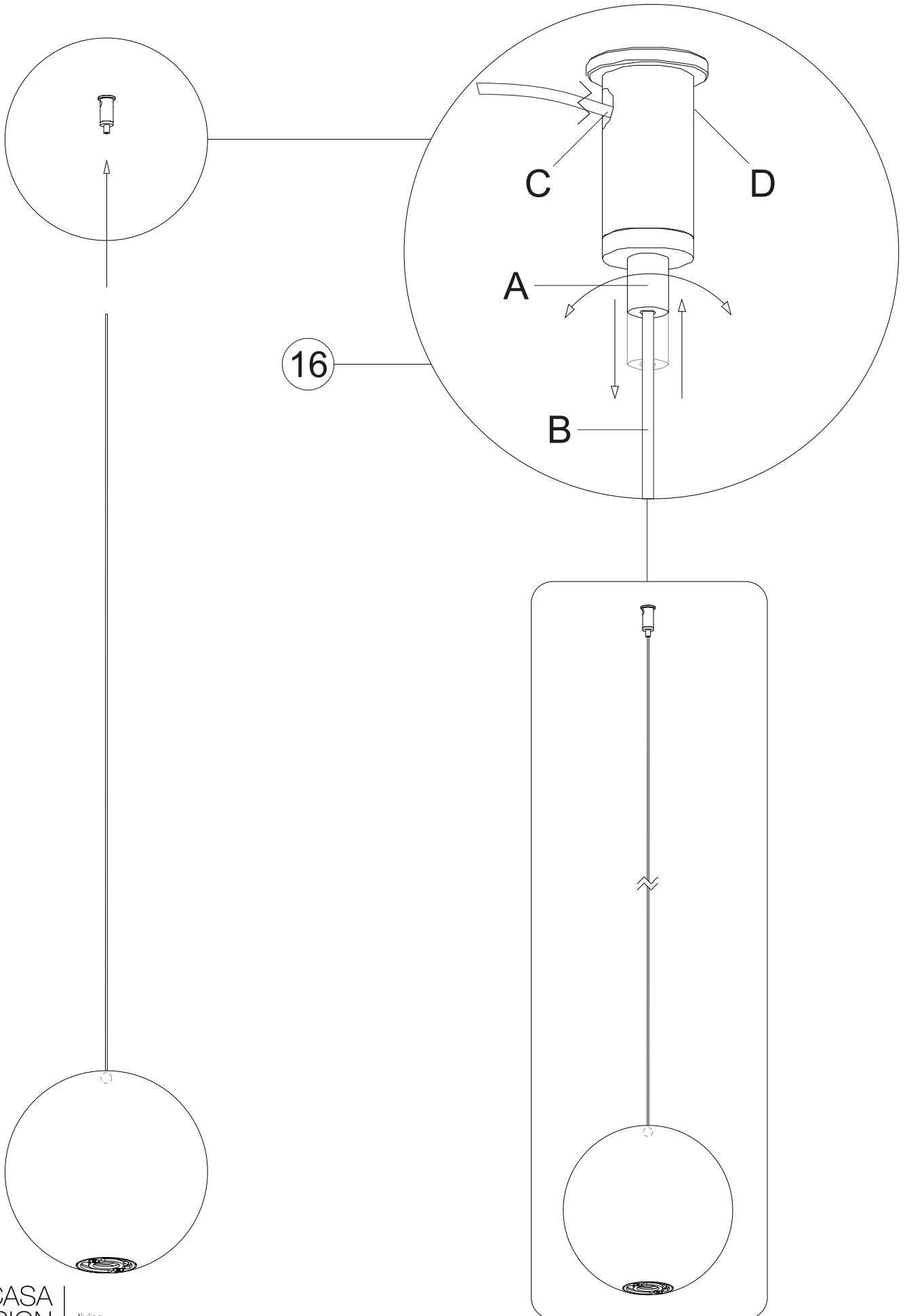

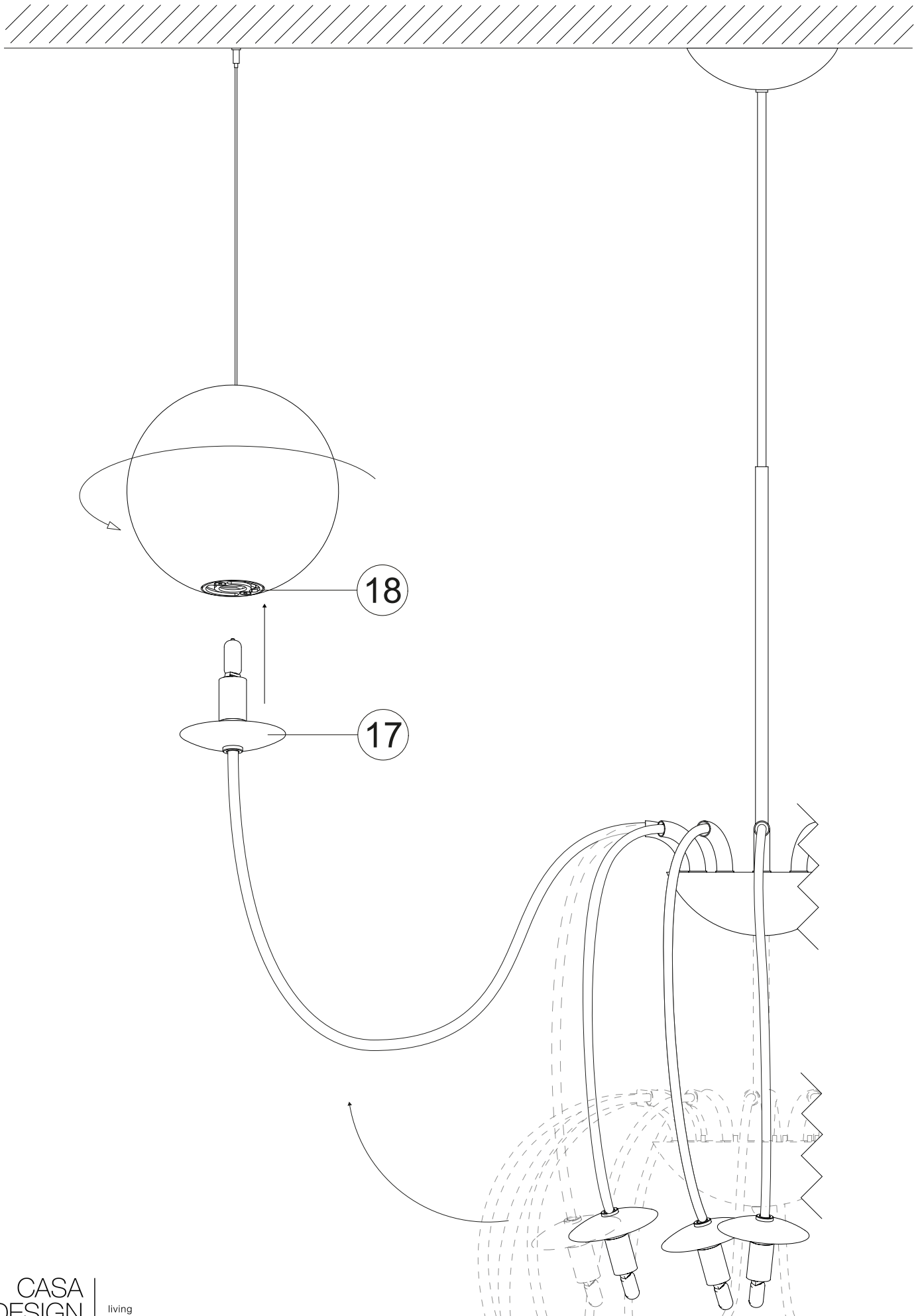

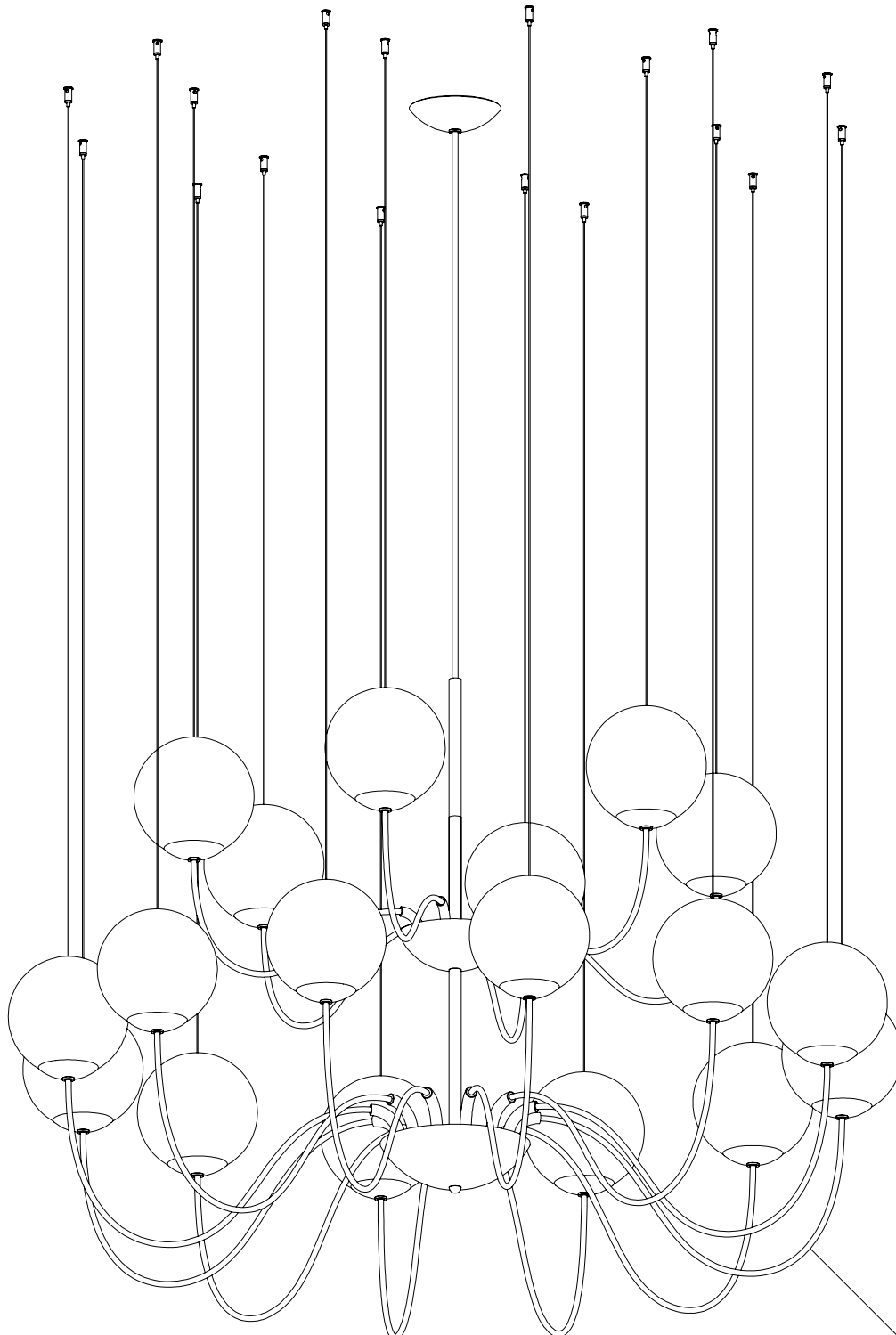

19

SP 18 P DOUBLE LEVEL

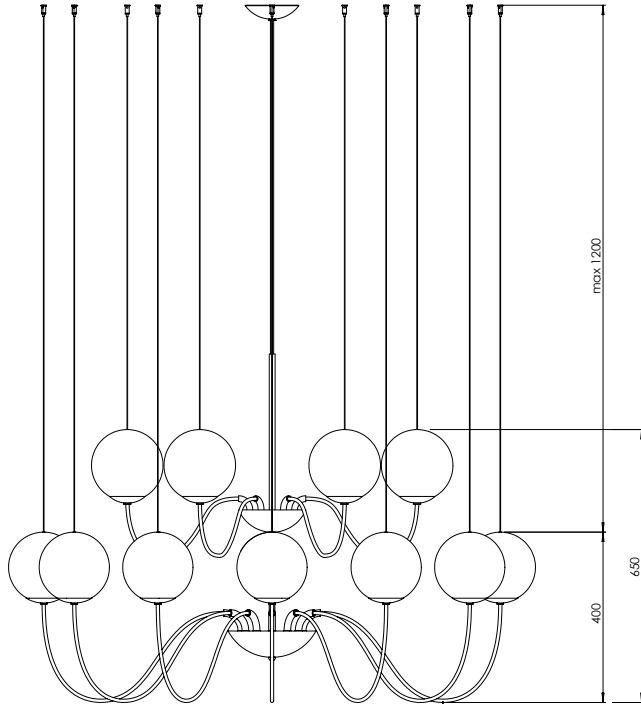

SP 18 P RANDOM

