



Elegant chair with legs in solid wood and structure made of polyurethane with back and seat in continuous line. Version without armrests, with cover in leather or fabric; the back of the chair cover can be plain or with rhombus stitching.

**STANDARD VERSION: PLAIN COVER**

CODE	SIZE	LEATHER FABRIC	A1	A2	A4
CLOE	W.53 x D.59 x H.48,5/85,5	D1	■	■	■
		D2	■	■	■
		D3	■	■	■
		D4	■	■	■
		D6	■	■	■

**AVAILABLE FINISHES:**

- A1:** walnut without knots
- A2:** oak without knots
- A4:** oak without knots pigmented: total black
- D1:** fabric: canvas, divina melange 2, hallingdal 65, velvet harald
- D2:** fabric: maple
- D3:** leather: camoscio, cristal
- D4:** leather: nabuk
- D6:** COL, COM

N.B.: cherry and maple availability and price on request

FEASIBILITY OPTION ON LEATHER / FABRIC	
RHOMBUS STITCHING ON THE BACK SIDE	■

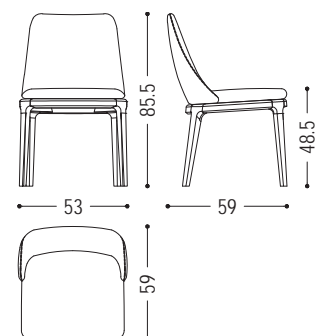

## WOOD

A1

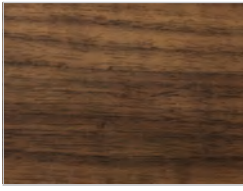

walnut without knots

A2

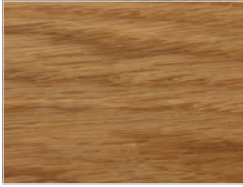

oak without knots

A4

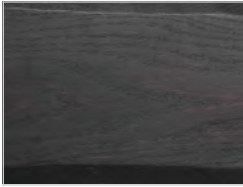

oak without knots pigmented:  
total black

LEATHER / FABRIC

D1



fabric:  
canvas:  
114

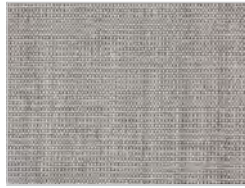

fabric:  
canvas:  
124

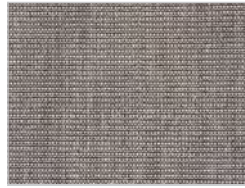

fabric:  
canvas:  
134

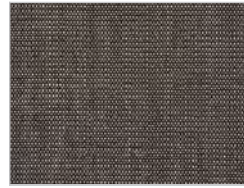

fabric:  
canvas:  
154



fabric:  
canvas:  
174



fabric:  
divina melange 2:  
120



fabric:  
divina melange 2:  
170



fabric:  
divina melange 2:  
180



fabric:  
divina melange 2:  
220



fabric:  
divina melange 2:  
260

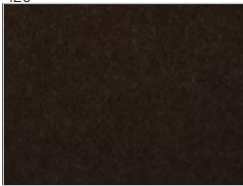

fabric:  
divina melange 2:  
280



fabric:  
hallingdal 65:  
103



fabric:  
hallingdal 65:  
116



fabric:  
hallingdal 65:  
130

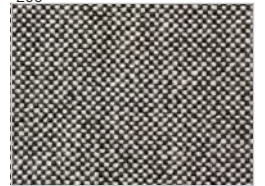

fabric:  
hallingdal 65:  
166



fabric:  
hallingdal 65:  
180

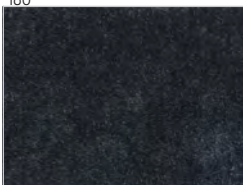

velvet fabric:  
harald:  
182

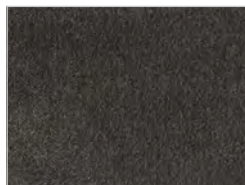

velvet fabric:  
harald:  
242

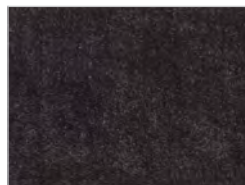

velvet fabric:  
harald:  
283

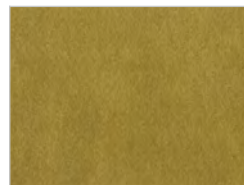

velvet fabric:  
harald:  
443

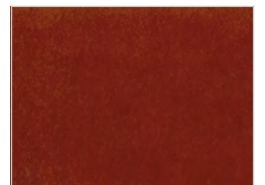

velvet fabric:  
harald:  
512

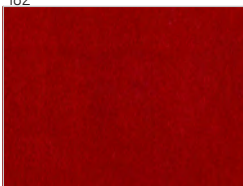

velvet fabric:  
harald:  
552

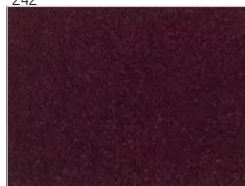

velvet fabric:  
harald:  
582

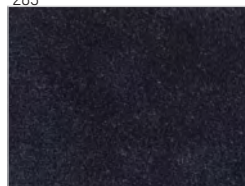

velvet fabric:  
harald:  
792

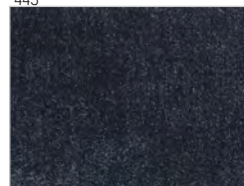

velvet fabric:  
harald:  
982



D2



fabric:  
maple:  
112



fabric:  
maple:  
132



fabric:  
maple:  
142



fabric:  
maple:  
162



fabric:  
maple:  
192



fabric:  
maple:  
222



fabric:  
maple:  
232



fabric:  
maple:  
362

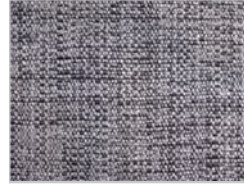

fabric:  
maple:  
742



fabric:  
maple:  
792

D3



Leather camoscio:  
1



Leather camoscio:  
10

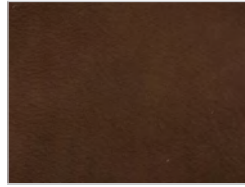

Leather camoscio:  
11



Leather camoscio:  
26



Leather camoscio:  
27



Leather camoscio:  
28



Leather camoscio:  
31

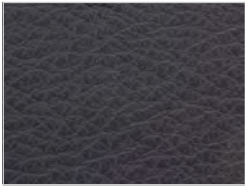

Leather cristal:  
13



Leather cristal:  
14



Leather cristal:  
17



Leather cristal:  
18



Leather cristal:  
37



Leather cristal:  
49



Leather cristal:  
51



Leather cristal:  
65

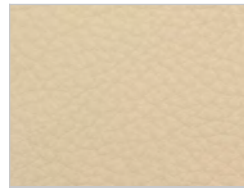

Leather cristal:  
70

# CLOE | AVAILABLE FINISHES

