

COVER OPEN



AN EXPRESSION OF THE CONSTANT TECHNICAL RESEARCH OF RIMADESIO, COVER OPEN IS AN INNOVATIVE WARDROBE SOLUTION, ALWAYS CUSTOM-MADE AND DESIGNED TO INTEGRATE PERFECTLY IN THE FREESTANDING VERSION WITH HINGED DOORS. AVAILABLE IN LINEAR, CORNER AND C-SHAPED COMPOSITIONS, IT GUARANTEES THE MAXIMUM DEGREE OF CUSTOMIZATION THANKS TO THE WIDE RANGE OF EQUIPMENT INCLUDED IN THE COVER SYSTEM.

IT Espressione della costante ricerca tecnica di Rimadesio, Cover Open è un'innovativa soluzione guardaroba, realizzata sempre su misura e perfettamente integrabile nella versione freestanding con ante battente. Disponibile in composizioni lineari, angolari e a C, garantisce il massimo grado di personalizzazione grazie all'ampia gamma di attrezzature previste dal sistema Cover.

FR Expression de la constante recherche technique de Rimadesio, Cover Open est une solution innovante de garde-robe, toujours réalisée sur mesure et parfaitement intégrable dans la version Freestanding avec portes battantes. Disponible dans des compositions linéaires, d'angles et en C, elle garantit la personnalisation la plus étendue possible grâce à la vaste gamme d'équipements prévue par le système Cover.

DE Cover Open ist Ausdruck der ständigen technischen Forschung von Rimadesio und eine innovative Garderobenslösung, die stets auf Maß gefertigt und perfekt in die Freestanding Version mit Flügeltüren integriert ist. Erhältlich in linearen, eckigen und C-förmigen Zusammensetzungen, garantiert es dank des breiten Ausstattungsspektrums des Cover-Systems ein Höchstmaß an Anpassung.

ES Expresión de la constante investigación técnica de Rimadesio, Cover Open es una solución de vestidor innovadora, siempre hecha a medida y perfectamente integrable en a versión Freestanding con puertas batientes. Disponible en composiciones lineales, angulares y en forma de C, garantiza el máximo grado de personalización gracias a la amplia gama de equipamiento que ofrece el sistema Cover.

STORAGE SYSTEM

design Giuseppe Bavuso

COVER OPEN



COVER OPEN

struttura/structure: 303 bronzo
fianchi e schienali/sides and back panels:
04 acidato bronzo

top e basamento/top and base: 303 bronzo
ripiani/shelves: 65 bronzo trasparente
accessori/accessories: 157 similpelle arena

Nella foto/In this photo
sistema contenitore/storage system: Cover

EN The Cover system now also includes the new open version: an exclusive project designed to create closet solutions with maximum flexibility of composition. Always custom-made in height and width, Cover Open guarantees the maximum degree of customization, thanks to a wide range of equipment and the possibility of alternating open compartments to storage units with hinged closing mechanism provided by the Cover freestanding system.

IT Il sistema Cover si arricchisce dell'inedita versione open: un progetto esclusivo ideato per creare soluzioni armadio con la massima flessibilità compositiva. Realizzato sempre su misura in altezza e larghezza, Cover Open garantisce il massimo grado di personalizzazione, grazie a un'ampia gamma di attrezzature e alla possibilità di alternare vani aperti a contenitori con chiusura battente previste dal sistema Cover freestanding.

DE Das Cover-System wurde mit der neuen Open-Version angereichert: es handelt sich um ein exklusives Projekt zur Entwicklung von Garderobenlösungen mit maximaler Flexibilität bei der Komposition. Cover Open ist immer auf Höhe und Breite zugeschnitten und garantiert dank einer breiten Palette an Geräten und der Möglichkeit, offene Fächer mit Klappbehältern zu wechseln, die vom Cover freestanding-System bereitgestellt werden, ein Höchstmaß an Anpassung.

FR Le système Cover s'enrichit de la version open inédite: un projet exclusif conçu pour créer des solutions de placard avec la plus grande flexibilité de composition. Toujours réalisé sur mesure en hauteur et en largeur, Cover Open permet une personnalisation maximum grâce à une ample gamme d'équipements et à la possibilité d'alterner des compartiments ouverts avec des conteneurs avec une fermeture battante prévus dans le système Cover freestanding.

ES El sistema Cover se enriquece con la inédita versión open: un proyecto exclusivo pensado para crear soluciones de armario con la máxima flexibilidad compositiva. Realizado siempre a medida en altura y anchura, Cover Open garantiza el máximo grado de personalización, gracias a una amplia gama de equipamientos y a la posibilidad de alternar los compartimentos abiertos y contenedores con cierre batiente que ofrece el sistema Cover freestanding.



COVER OPEN

struttura/structure: 303 bronzo
fianchi e schienali/sides and back panels:
04 acidato bronzo

top e basamento/top and base: 303 bronzo
ripiani/shelves: 65 bronzo trasparente
accessori/accessories: 157 similpelle arena



COVER OPEN
struttura/structure: 303 bronzo
top, basamento e cassettiere/top, base and
drawer units: 07 melaminico olmo
fianchi e schienali/sides and back panels:
03 acidato grigio
ripiani/sheves: 63 grigio trasparente
accessori/accessories: 154 similpelle argilla

EN Cover Open is emphasized by aluminium front profiles, designed to enhance the wardrobe elements and to highlight their aesthetic minimalism. There is a wide variety of materials and finishes: the structure is available in 6 colours for the Cover system. Top and floor base are available in lacquered wood in the 46 Ecolorsystem colours, as well as in the 3 melamine finishes. The accessories are available in synthetic leather in 7 exclusive colours of Rimadesio.

IT Cover Open è scandito da profili frontali in alluminio, progettati per valorizzare gli elementi guardaroba e rimarcare il minimalismo estetico. Ampia è la varietà di materiali e finiture: la struttura è disponibile nelle 6 cromie previste dal sistema Cover. Top e basamento interno sono disponibili in legno laccato nei 46 colori Ecolorsystem, oltre che nelle 3 finiture in melaminico. Gli accessori sono disponibili in similpelle in 7 tonalità esclusive Rimadesio.

DE Cover Open wird von Aluminium-Frontprofilen unterbrochen, die die Garderobenelemente aufwerten und ihren ästhetischen Minimalismus unterstreichen sollen. Es gibt eine Vielzahl von Materialien und Oberflächen: Die Struktur ist in den 6 vom Cover-System bereitgestellten Farben erhältlich. Deckel- und Basisboden sind in lackiertem Holz in den 46 Ecolorsystem Farben, sowie in den 3 Melamin-Ausführungen erhältlich. Die Accessoires sind in Kunstleder in 7 exklusiven Rimadesio-Farben erhältlich.

FR Cover Open est caractérisé par de profils frontaux en aluminium, conçus pour valoriser les éléments de la garde robe et souligner l'esthétique minimaliste. Les matériaux et les finitions sont proposés dans une grande variété: la structure est disponible dans les 6 couleurs prévues par le système Cover. Top et base au sol intérieure sont disponibles en bois laqué dans les 46 couleurs Ecolorsystem, ainsi que dans les 3 finitions en mélaminé. Les accessoires sont disponibles en similicuir en 7 tonalités exclusives Rimadesio.

ES Cover Open presenta perfiles frontales de aluminio, diseñados para realzar los elementos del vestidor y remarcar su minimalismo estético. Existe una amplia variedad de materiales y acabados: la estructura está disponible en los 6 colores del sistema Cover. El top y la base interna están disponibles en madera lacada en los 46 colores de Ecolorsystem, así como en los 3 acabados de melamina. Los accesorios están disponibles en simil cuero en 7 tonalidades exclusivas de Rimadesio.



COVER OPEN

struttura/structure: 303 bronzo
fianchi e schienali/sides and back panels:
04 acidato bronzo
top e basamento/top and base: 303 bronzo
accessori/accessories: 157 similpelle arena

SELF BOLD

struttura/structure: 207 platino graffiato
frontali/fronts: 404 platino diamante
top marmo/marble top: 28 calacatta



COVER OPEN

struttura/structure: 303 bronzo
fianchi e schienali/sides and back panels:
04 acidato bronzo

top e basamento/top and base: 303 bronzo
ripiani/shelves: 65 bronzo trasparente
accessori/accessories: 157 similpelle arena

Cover Open



Composizione lineare Cover Open
Linear composition Cover Open

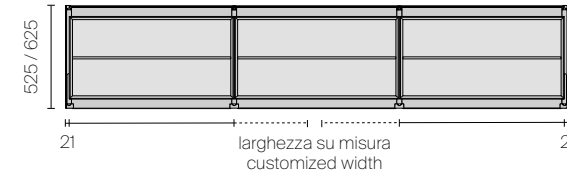

Composizione lineare Cover Open + Cover freestanding
Linear composition Cover Open + Cover freestanding

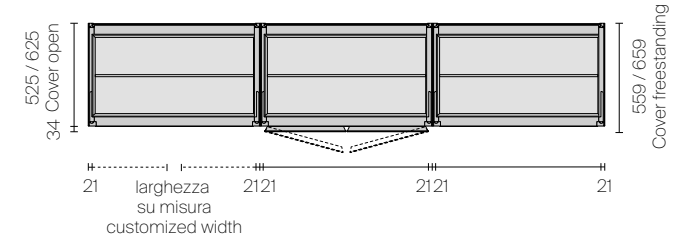

Composizione lineare Cover Open + Cover freestanding
Linear composition Cover Open + Cover freestanding

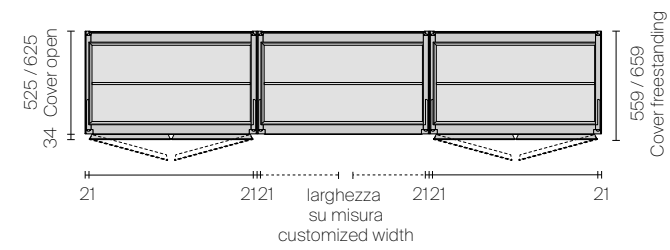

Composizione lineare Cover Open + Cover freestanding
Linear composition Cover Open + Cover freestanding

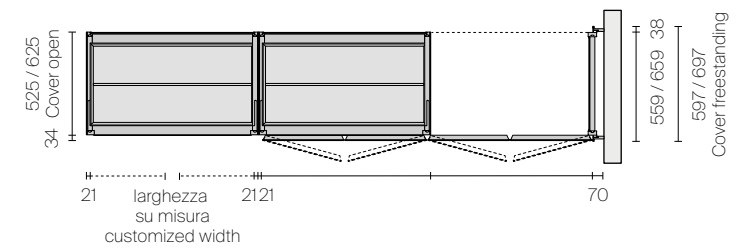

Cover Open + Cover freestanding

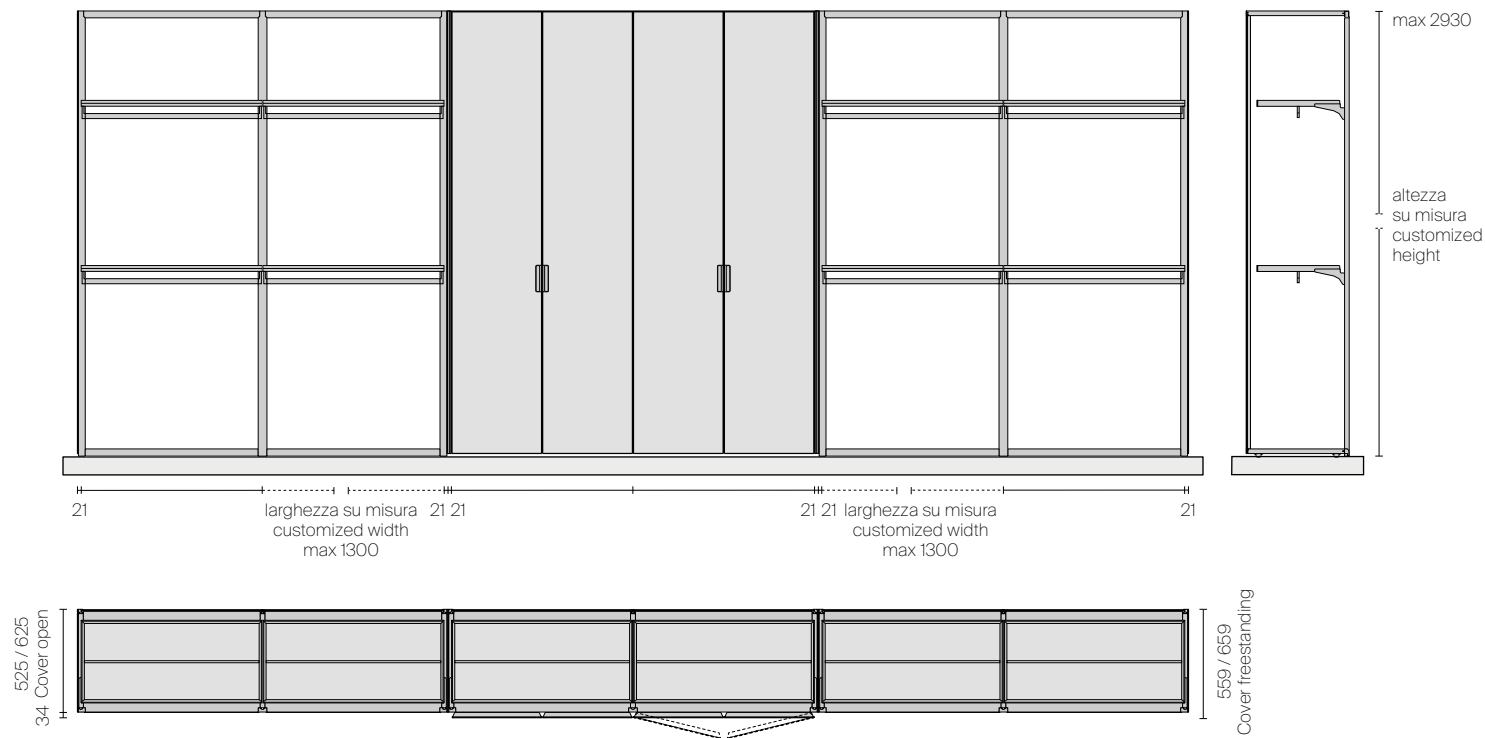

Composizione ad angolo Cover Open
Composition with internal corner Cover Open

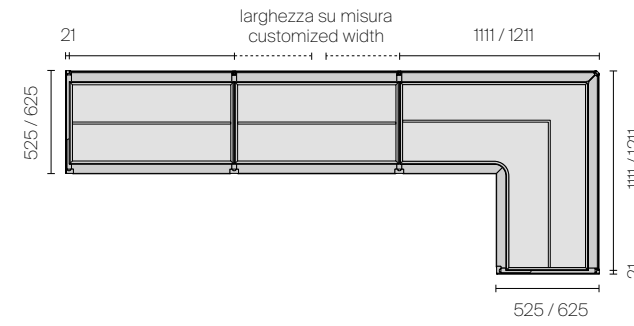

Composizione a C Cover Open
C-shaped composition Cover Open

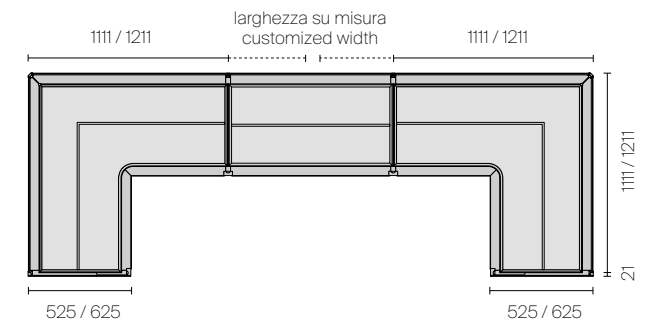

Composizione ad angolo Cover Open + Cover freestanding
Corner composition Cover Open + Cover freestanding

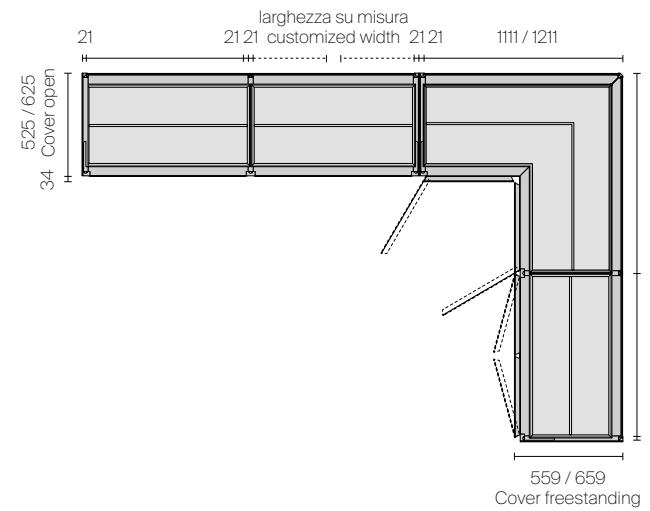

Composizione a C Cover Open + Cover freestanding
C-shaped composition Cover Open + Cover freestanding

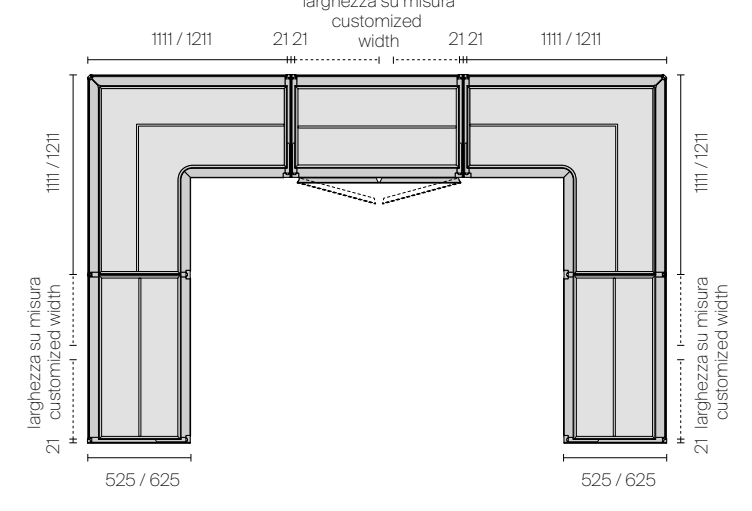

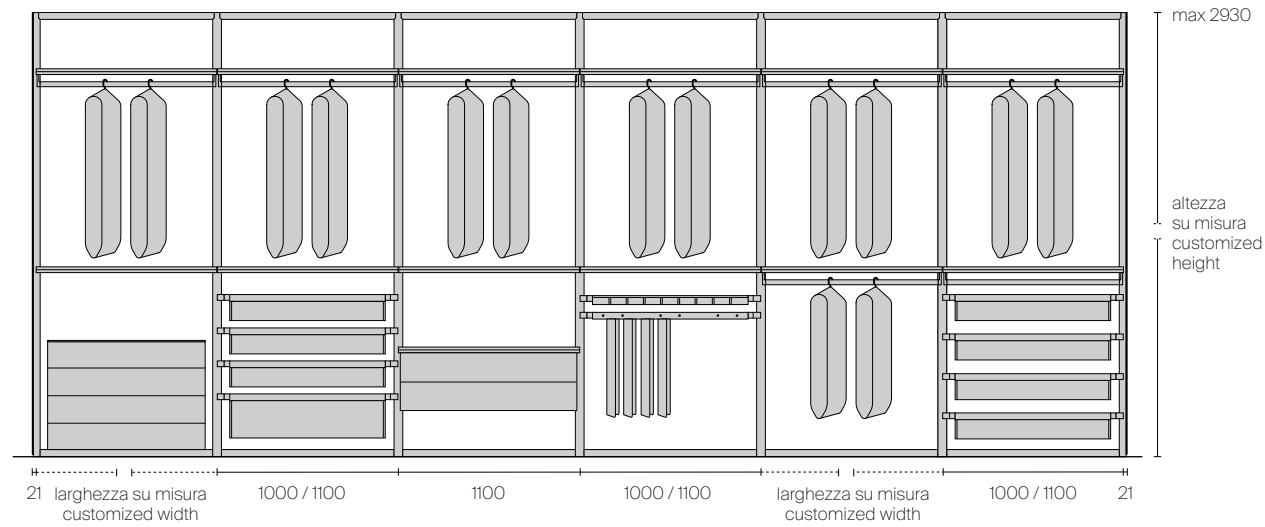

Fianco finale sp 48 mm, fianco intermedio sp 53 mm. Illuminazione a led opzionale anteriore e posteriore. Disponibile con rivestimento in vetro singolo frontale temperato sp 4 mm, Litech, tessuto, similpelle e essenza sahara / Closing side panel thickness 48 mm, middle frame thickness 53 mm. Optional front and rear led lighting system available with single 4 mm thick tempered glass, Litech, fabric, synthetic leather and sahara wood fronts

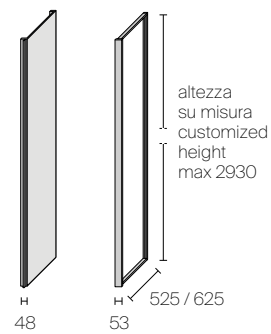

Schienale in vetro temperato spessore 6 mm, disponibile nei vetri laccati, trasparenti e satinati / Back panel in tempered glass thickness 6 mm, available in lacquered, transparent and satined glass

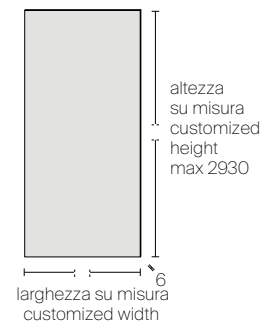

Basamento e top in legno laccato o in melaminico / Floor base and top in lacquered wood or melamine

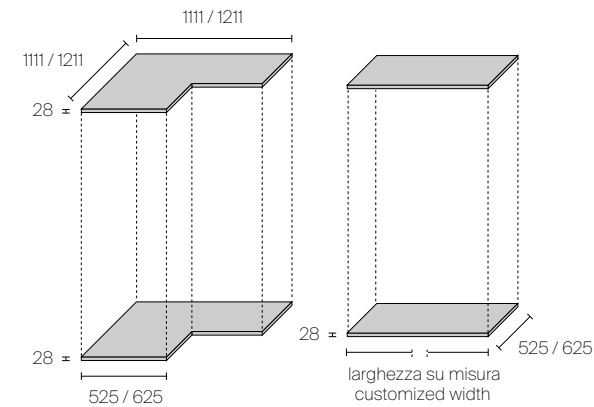

Ripiano estraibile con vaschetta in similpelle / Pull out shelf with tray in synthetic leather

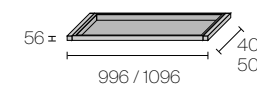

Contenitore in essenza di noce / Walnut veneered organizer

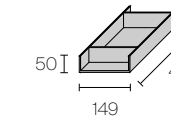

Separatore doppio / Organizer with double partition

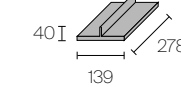

Porta orologi / Watch holder

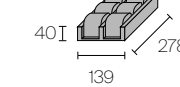

Vaschetta concava e vaschetta con fessure / Concave box and box with jewels slots

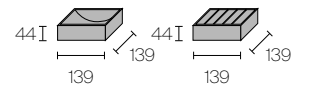

Ripiano con portapantaloni estraibile e vano portacinture / Shelf with removable trousers rack and belt tray

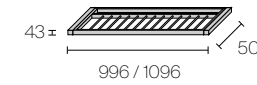

Ripiano estraibile portacravatte in similpelle / Pull out shelf with tie rack in synthetic leather

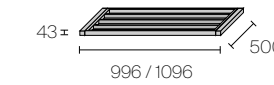

Ripiano estraibile portascarpe in similpelle / Pull out shelf with shoe rack in synthetic leather

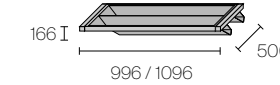

Ripiano estraibile con organizer in similpelle / Pull out shelf with organizer tray in synthetic leather

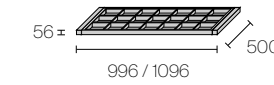

Cesta e vassoio in similpelle / Synthetic leather box and tray

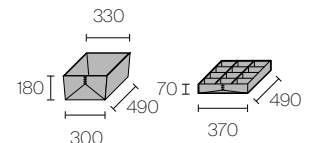

Cesto basso e alto estraibili in similpelle / Pull out small and big trays in synthetic leather

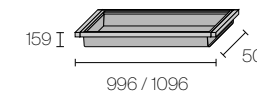

Mensola in melaminico con profilo posteriore in alluminio / Melamine shelf with rear aluminium profile

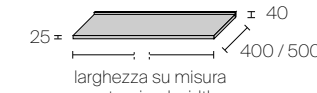

Mensola in vetro con ring in alluminio e top opzionale in similpelle / Glass shelf with aluminium ring and optional top in synthetic leather

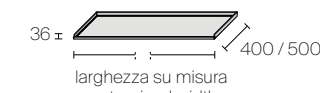

Asta portabiti per mensola e sottotop con rivestimento opzionale in similpelle / Cloth hanger for shelf and undertop with optional cover in synthetic leather

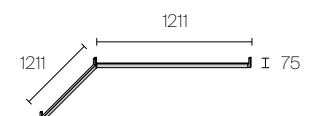
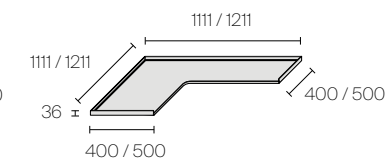
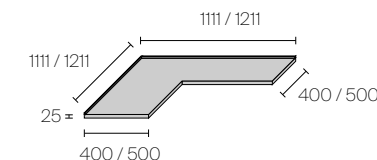
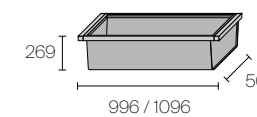
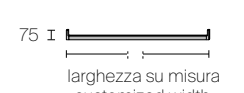

Cassettiera sospesa in legno laccato o melaminico, top in specchio grigio. Top opzionale in similpelle / Suspended drawer unit in lacquered wood or melamine, top in gray mirror. Optional top in synthetic leather

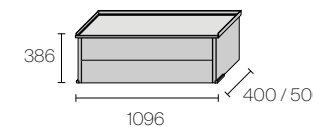

Cassettiera per basamento. In melaminico con tre cassetti, in vetro laccato o in melaminico con quattro cassetti / Drawer unit on floor base. In melamine with three drawers, in lacquered glass or in melamine with four drawers

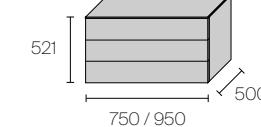

Top opzionale in melaminico con fondo rivestito in similpelle, per cassetteria su basamento / Optional top in melamine with bottom part covered with synthetic leather, for drawer units on floor base

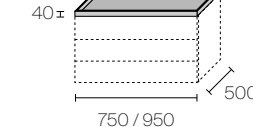

Tovaglietta opzionale in similpelle per fondo cassetti / Optional synthetic leather mat for internal lining

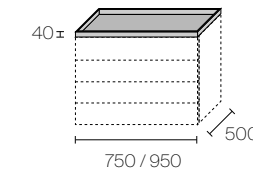
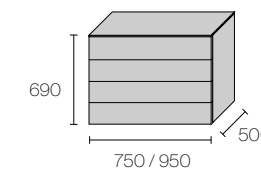



Sistema di fissaggio degli accessori
Accessories fixing system



Tutti gli accessori vengono fissati ai montanti con un sistema ad incastro, senza viti a vista, e la disposizione può essere modificata e variata nel tempo con estrema facilità.
All the elements are fixed directly to the uprights, without visible screws, and the layout can be modified any time in an easy way.

EN The Cover Open system is always tailor-made in height and width and is available in two depths. The structure and the innovative front profiles are made of aluminium. The base and the top are available in melamine, in larice carbone, rovere grigio and olmo finishes or in the 46 Ecolorsystem lacquered colours.

IT Il sistema Cover Open è realizzato sempre su misura in altezza e larghezza ed è disponibile in due profondità. La struttura e gli innovativi profili frontali sono realizzati in alluminio. Il basamento e il top sono disponibili in melaminico, nelle finiture larice carbone, rovere grigio e olmo o nei 46 colori laccati Ecolorsystem.

DE Das Cover Open-System wird immer in Höhe und Breite gemessen und ist in zwei Tiefen erhältlich. Die Struktur und die innovativen Frontprofile bestehen aus Aluminium. Die Basis und die Oberseite sind in Melamin, in den Ausführungen Holzkohle-Lärche, Grau-Eiche und Ulme oder in den 46 Ecolorsystem-Lackfarben erhältlich.

FR Le système Cover Open est toujours réalisé sur mesure en hauteur et en largeur et disponible en deux profondeurs. La structure et les profils de face sont réalisés en aluminium. La base et le top ont disponibles en mélaminé, dans les finitions mélèze, chêne gris et orme et dans les 46 couleurs laquées Ecolorsystem.

ES El sistema Cover Open se realiza siempre a medida en altura y anchura y está disponible en dos profundidades. La estructura y los innovadores perfiles frontales son de aluminio. La base y el top están disponibles en melamina, en los acabados alerce carbón, roble gris y olmo o en los 46 colores lacados Ecolorsystem.

STORAGE SYSTEM

COVER OPEN

Struttura e accessori
Structure and accessories

ALLUMINIO/ALUMINIUM

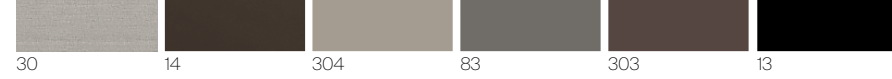

Schienale
Back panel

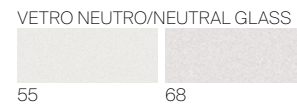
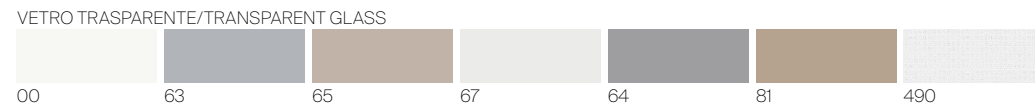
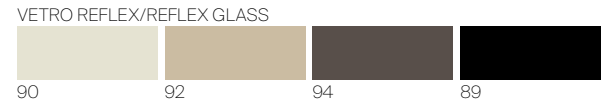
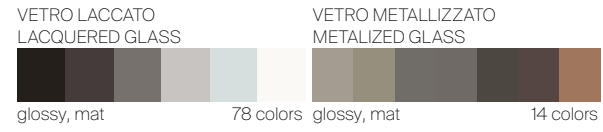

Fianco
Side panel

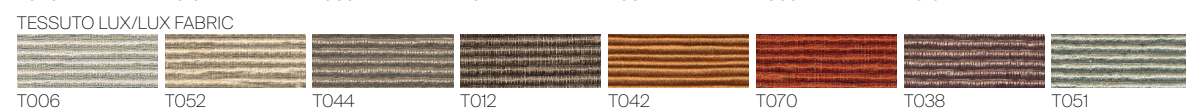
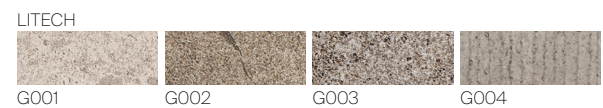
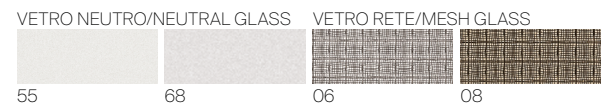
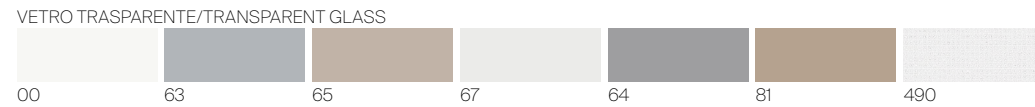
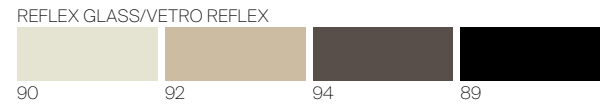

Basamento e top
Floor base and top

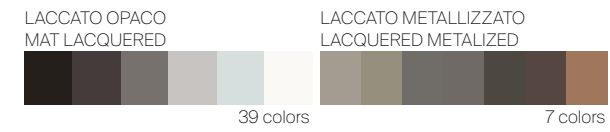

Cassettiera
Drawer unit

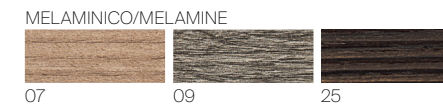
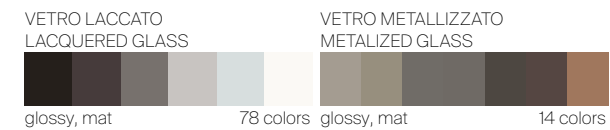

Interno cassetiera
Internal drawer unit



Cassettiera sospesa
Suspended drawer unit

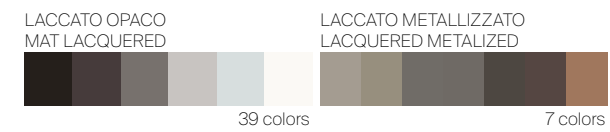

Mensola
Shelf

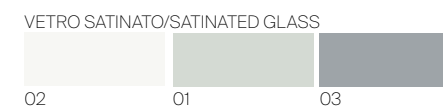
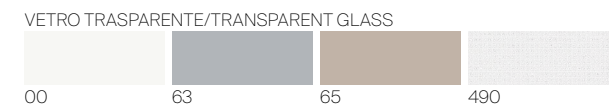

Ripiano estraibile, rivestimento asta portabiti e tovaglietta opzionale per fondo cassetto
Pull out shelf, cloth hanger bar and optional mat for internal lining



QUALITY AS THE MAIN PURPOSE, ALWAYS AND IN EVERY ASPECT. WITH THIS MISSION RIMADESIO IS CONSTANTLY SEARCHING FOR SOLUTIONS TO IMPROVE ITS OWN ECOLOGICAL STANDARDS.

OBJECTIVE OBTAINED THANKS TO THE USE OF PRECIOUS AND RECYCLABLE MATERIALS, TO THE ABSENCE OF SUBSTANCES THAT CAN BE TOXIC TO HUMANS OR HARMFUL TO THE ENVIRONMENT IN EVERY PHASE OF THE PRODUCTIVE PROCESS, TO THE USE OF TECHNOLOGY AND EVOLVED MACHINERY, POWERED BY CLEAN ENERGY DERIVED FROM LATEST GENERATION PHOTOVOLTAIC SYSTEMS, INSTALLED ON GIUSSANO HEADQUARTERS ROOF.

ALUMINIUM, GLASS, WOOD: FULLY RECYCLABLE MATERIALS AND PARTLY ALREADY RECYCLED, BUT ALSO ECOLORSYSTEM PAINTS WITHOUT SOLVENTS AND ECOLOGICAL PACKING MATERIALS.

PROOFS OF A REINFORCED GREEN DNA AND WIDE COHERENCE, SIGNALS OF A CONTINUOUS RESEARCH AND A GLANCE TOWARDS THE FUTURE, THAT TAKES SHAPE IN THE TECHNOLOGICAL INNOVATION OF SYSTEMS, DOORS AND FURNITURE, MADE WITH THE CONSCIOUSNESS TO ENTRUST JUST HIGH ADDED VALUE ACT.

EXCELLENCE SUSTAINABILITY PROJECT

IT Perseguire la qualità, sempre, sotto tutti gli aspetti. Con questa mission Rimadesio ricerca costantemente soluzioni volte a migliorare i propri standard qualitativi ecologici. Obiettivo ottenuto sinergicamente, grazie all'utilizzo di materiali preziosi e riciclabili, all'assenza di sostanze tossiche per l'uomo e nocive per l'ambiente in ogni fase del processo produttivo, all'impiego di tecnologie e macchinari evoluti alimentati con energia pulita proveniente da impianti fotovoltaici di ultima generazione, installati sulla copertura dell'headquarter di Giussano. Alluminio, vetro, legno, materiali totalmente riciclabili e in parte già riciclati, ma anche le vernici prive di solventi di Ecolorsystem e i sistemi di imballaggio ecologici. Testimonianze di un dna green consolidato e di una coerenza trasversale, segnali di una continua attività di ricerca e di uno sguardo sempre proteso al futuro che si declina nell'innovazione tecnologica di sistemi, porte ed arredi, realizzati con la consapevolezza di voler affidare all'uomo solo attività dall'alto valore aggiunto.

DE Streben nach Qualität, unter allen Gesichtspunkten. Mit dieser Mission forscht Rimadesio ständig nach ökologischen Lösungen. Ein Ziel, welches sich aus Synergien ergibt, dank der Verwendung von hochwertigen und recycelbaren Materialien, dem Ausschluss von für den Menschen giftigen und umweltschädlichen Substanzen und den Antrieb der Produktionsanlagen mit sauberem Strom, welcher durch Photovoltaikanlagen neuester Generation erzeugt wird. Aluminium, Glas, Holz, völlig recycelbare oder schon recycelte Materialien, aber auch die lösungsmittelfreien Farben des Ecolorsystems und die umweltfreundlichen Verpackungsmaterialien. Alles Belege für eine fundierte grüne dna und in einem übergreifenden Zusammenhang. Zeichen für eine kontinuierliche Forschungsaktivität und einen zukunftsorientierten Blick, die sich in den Innovationen der technischen Systemen, der Türen und Möbeln ausdrücken, welche mit dem Bewusstsein entwickelt werden, dem Menschen den größtmöglichen Zusatznutzen zu bieten.

FR Poursuivre la qualité, toujours, et à tous les égards. Avec cette mission Rimadesio recherche constamment de solutions au fin d'améliorer ses normes de qualité écologique. Objectif atteint, grâce à l'utilisation de matériaux précieux et recyclables, l'absence à chaque étape de la production de substances toxiques nocives pour l'homme et l'environnement, l'utilisation de technologies et des machines avancées alimentées par l'énergie solaire après l'installation sur le toit de l'usine à Giussano de systèmes photovoltaïques de dernière génération. Aluminium, verre, bois, des matériaux entièrement recyclables et déjà en partie recyclés, mais aussi peinture Ecolorsystem sans solvants et systèmes d'emballage respectueux de l'environnement. Témoignages d'un adn "vert" consolidé et d'une cohérence transversale, signes de recherche continue et d'une tendance à regarder en avant, qui correspond bien à l'innovation technologique des systèmes, des portes et des meubles, réalisés avec la conscience que l'apport de l'homme dans la production ne peut qu'avoir un valeur ajoutée.

ES Perseguir la calidad, siempre, en todos los aspectos. Con esta misión Rimadesio busca constantemente soluciones destinadas a mejorar sus estándares de calidad ecológica. Objetivo conseguido sinérgicamente, gracias al uso de materiales preciosos y reciclables, a la ausencia de sustancias tóxicas para los seres humanos y nocivas para el medio ambiente en cada etapa del proceso de producción, al uso de tecnologías y máquinas avanzadas alimentadas por energía limpia a partir de sistemas fotovoltaicos de última generación, instalados en la cobertura del headquarter de Giussano. Aluminio, cristal, madera, materiales completamente reciclables y, en parte, ya reciclados, sino también las pinturas Ecolorsystem libres de disolventes y los sistemas de embalaje ecológicos. Testimonios de un adn green consolidado y una coherencia transversal, señales de una continua investigación y de una vista siempre tendida al futuro que se declina en la innovación tecnológica de sistemas, puertas y muebles, realizados con el conocimiento que desea confiar al hombre sólo actividades de alto valor añadido.

ECOLORSYSTEM
VETRO LACCATO/LACQUERED GLASS

GLOSSY MAT		GLOSSY MAT		GLOSSY MAT		GLOSSY MAT		GLOSSY MAT		GLOSSY MAT			
305	138 cipria	45	97 avorio	59	105 grigio chiaro	40	115 grigio cenere	53	95 bianco neve	50	108 bianco latte		
51	113 nocciola	52	107 corda	56	98 lino	312	145 grigio seta	47	96 grigio perla	78	114 sabbia		
306	139 terracotta	85	130 tufo	310	143 creta	38	121 azzurro cera	36	117 blu Londra	74	110 canapa		
76	116 rosso india	308	141 pepe	317	600 grigio artico	35	100 blu notte	39	122 verde inglese	73	109 giallo kashmir		
75	129 amaranto	309	142 sandalo	88	132 grigio scuro	86	131 blu oceano	314	147 verde lichene	43	119 laguna		
307	140 java	58	99 caffè	311	144 grigio lava	313	146 blu scuro	315	148 verde scuro	33	111 verde oliva		
		84	128 moro	46	102 nero					316	149 verde terra		

ECOLORSYSTEM
VETRO SAHARA/SAHARA GLASS

505	cipria sahara	508	pepe sahara	520	grigio chiaro sahara	512	grigio seta sahara	514	verde lichene sahara	523	verde oliva sahara
506	terracotta sahara	509	sandalo sahara	517	lino sahara	522	blu oceano sahara	515	verde scuro sahara	516	verde terra sahara
507	amaranto sahara	519	caffè sahara	510	creta sahara	513	blu scuro sahara				
				524	grigio artico sahara						
				521	grigio scuro sahara						
				511	grigio lava sahara						

ECOLORSYSTEM
VETRO METALLIZZATO/METALIZED GLASS

GLOSSY MAT		GLOSSY MAT		SAHARA		SAHARA		DIAMANTE		DIAMANTE			
304	137 platino	302	135 grafite	504	platino sahara	502	grafite sahara	404	platino diamante	402	grafite diamante		
69	126 palladio	303	136 bronzo	569	palladio sahara	503	bronzo sahara	469	palladio diamante	403	bronzo diamante		
83	127 piombo	300	133 rame	583	piombo sahara	500	rame sahara	483	piombo diamante	400	rame diamante		
301	134 peltro			501	peltro sahara			401	peltro diamante				

VETRO NEUTRO NEUTRAL GLASS		VETRO TRASPARENTE TRANSPARENT GLASS		VETRO SATINATO SATINATED GLASS		VETRO RETE MESH GLASS		VETRO REFLEX REFLEX GLASS			
55	specchio	590	trasparente sahara	67	riflettente chiaro	591	acidato sahara	60	rete alluminio	90	bianco reflex
68	specchio grigio	490	trasparente diamante	64	riflettente grigio	02	acidato extrachiaro	61	rete inox	92	kaki reflex
		05	trasparente extrachiaro	81	riflettente bronzo	01	acidato	62	rete bronzo	94	cacao reflex
		00	trasparente			03	acidato grigio	66	maglia gold	89	nero reflex
		63	grigio trasparente			04	acidato bronzo	87	maglia rame		
		65	bronzo trasparente			82	nuvola extrachiaro	06	fibra argento		
		390	verde trasparente			80	nuvola	08	fibra bronzo		
		391	blu trasparente								

ECOLORSYSTEM
LACCATO OPACO/MAT LACQUERED



CUOIO
LEATHER

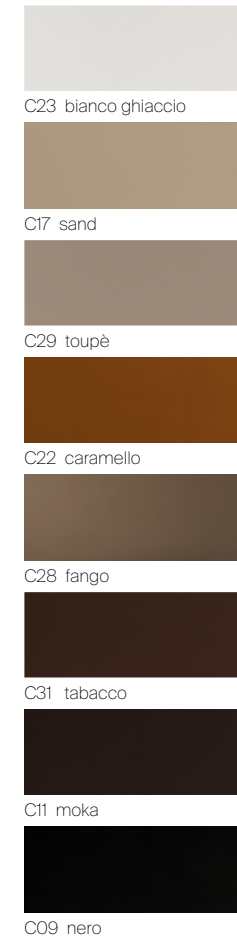

SIMILPELLE
SYNTHETIC LEATHER



TESSUTO LUX
LUX FABRIC

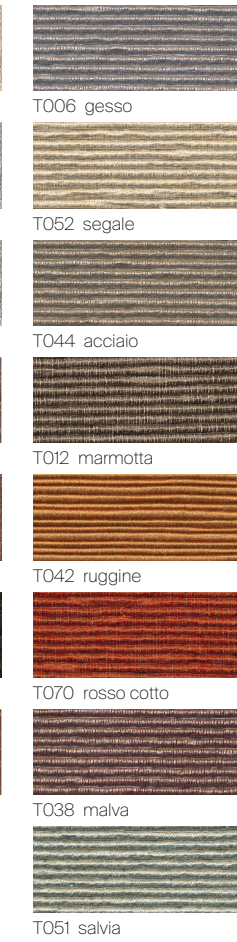

TESSUTO MATERIAL
MATERIAL FABRIC



MARMO
MARBLE

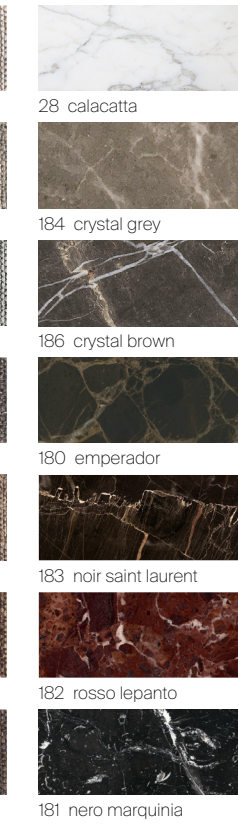

MARMO OPACO
MAT MARBLE

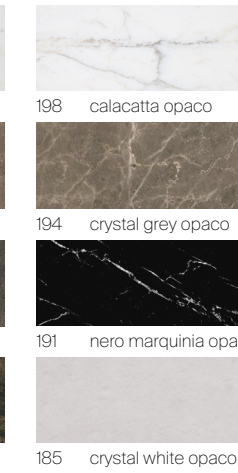

ECOLORSYSTEM
LACCATO METALLIZZATO/LACQUERED METALIZED



ALLUMINIO GRAFFIATO
SCRAPED ALUMINIUM



ALLUMINIO
ALUMINIUM

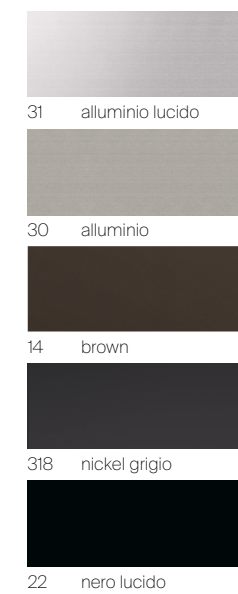

LITECH



ESSENZA
WOOD



ESSENZA SAHARA
SAHARA WOOD



MELAMINICO
MELAMINE



MELAMINICO INTERNO
INTERNAL MELAMINE

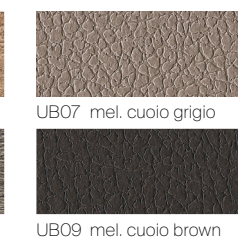

Rimadesio spa
Via Furlanelli 96
20833 Giussano (MB) Italy
T +39 0362 3171
F +39 0362 317317
rimadesio@rimadesio.it

Milano Flagship store
via Visconti di Modrone 26
20122 Milano Italy
T-F +39 02 76280708
milano@rimadesio.it

London Flagship store
83-85, Wigmore street
1WU 1DL London
T +44 2074 862193
london@rimadesio.co.uk

www.rimadesio.it