

ORIGIN



CASA
DESIGN
GROUP

INDEX

Introducción	05	Introduction	05
Sostenibilidad	09	Sustainability	09
Diseñador	13	Designer	13
ORIGIN	17	ORIGIN	17
DETALLES TÉCNICOS	49	TECHNICAL DETAILS	49
IMÁGENES	58	PICTURES	58
ACABADOS Y MANTENIMIENTO	61	FINISHES AND MAINTENANCE	61
TELAS	69	FABRICS	69

INTRO- DUCTION

El reto de una empresa centenaria es crecer siendo fiel a los principios que han construido su historia de éxito. La cuarta generación al frente de POINT parte del respeto y el aprendizaje del pasado para construir el futuro. La marca nace en 1920 y casi 100 años después, en 2019, su trayectoria es reconocida con el Premio Nacional de Diseño. Una distinción que recompensa un catálogo lleno de propuestas firmadas por grandes nombres del diseño industrial como Mario Ruiz, Gabriel Teixidó, Vicent Martínez o Christophe Pillet, en colecciones que acaparan también otros tantos galardones. Pero en el reconocimiento también están presentes las distintas generaciones que han sabido transformar un taller artesanal en una marca que vende en más de 70 países y que es un aliado en los espacios exteriores de las cadenas hoteleras más prestigiosas.

Hoy podemos encontrar en la oferta de POINT los principios de confort, diseño y durabilidad que marcaron las primeras piezas del fundador, José Pons Pedro, en la década de los años 20 del siglo pasado. En nuestro catálogo –como en muchos de nuestros proyectos– conviven los modelos más actuales y los más clásicos. Todos ellos han sido creados pensando en el planeta, porque nacen del amor de la familia Pons por su tierra. El abuelo José soñó con hacer muebles con la materia prima –el mimbre– con la que se hacían los capazos. Un oficio que aprendió en Argentina y cuyos secretos compartió con la gente de la Marina Alta a su regreso. Hoy conforman el ADN de nuestra marca centenaria.

The challenge for a century-old company is to grow while still remaining faithful to the principles that underpin its success story. With the fourth generation at the helm of POINT, they approach their role with respect for the past, learning from it to build the future. The brand was created in 1920 and almost 100 years later, in 2019, its accomplishments were recognised with the National Design Award, a distinction that rewards a catalogue full of proposals designed by great names in industrial design such as Mario Ruiz, Gabriel Teixidó, Vicent Martínez and Christophe Pillet, in collections that have also earned many awards. But this award also acknowledges the different generations that have managed to transform a handmade furniture workshop into a brand that sells its products in over 70 countries and is featured in the outdoor spaces of the most prestigious hotel chains.

Today POINT's furniture is characterised by the principles of comfort, design and durability that marked the first pieces made by the founder, José Pons Pedro, in the 1920s. In our catalogue, as in many of our projects, the most modern pieces sit alongside the most classic models. All of them have been created with the planet in mind, because they are born out of the Pons family's love for their land. José, the grandfather of the current owners, dreamt of making furniture with the raw material –wicker– that baskets were woven from, a trade he learnt in Argentina and whose secrets he shared with the people of the Marina Alta area on his return. Today they form the DNA of our century-old brand.

POINT AND SUSTAINA- BILITY

En 1920, José Pons Pedro regresa a su tierra después de varios años “haciendo las Américas”. Retorna con un oficio aprendido, el de artesano trenzador de mimbre. En la comarca de la Marina Alta, encuentra la materia prima, el mimbre. Con ella empieza a crear muebles –una revolución en la época– que unen belleza y durabilidad. Sin saberlo, hace más de un siglo la sostenibilidad estaba en cada una de sus piezas.

Durante 10 décadas esta filosofía ha estado presente en cada generación que ha legado el buen hacer del fundador de POINT. El reto para la tercera y cuarta generación ha sido introducir en la industrialización toda la sabiduría y respeto a la tierra que ha marcado nuestra historia. Una de las primeras lecciones aprendidas es que no hay nada más sostenible que un mueble duradero que puede pasar, incluso, de generación en generación. Cada uno de nuestros diseños está pensado para durar. Otra enseñanza ha sido buscar aquellos materiales que no causen impacto medioambiental. En POINT hemos desarrollado un protocolo interno de diseño que exige trabajar con componentes reciclables –para que todos tengan una segunda vida útil– y que, tanto en los procesos de fabricación como en el tratamiento de residuos generados, cumplan con el objetivo de cuidar el planeta. Son los retos que hemos puesto a cada uno de nuestros diseñadores.

De esta forma, una colección donde la madera –teca de grado A– sea protagonista, tendrá su origen en bosques sostenibles de tala controlada. Estas maderas contienen un alto nivel de aceite y gomas naturales, que le otorgan una alta flexibilidad y durabilidad. Su aceite natural se conjuga con una resina antiséptica propia que asegura que el paso del tiempo se convierta en un aliado de cada pieza. Se apuesta por materiales como el aluminio, que es muy resistente y 100% reciclable. Se puede transformar y reintroducir en el ciclo de producción. La selección de los tejidos no solo tiene un sentido estético, también lo tiene funcional y comprometido con el medioambiente. Todos son lavables, reversibles, duraderos y de alta calidad. Así se limita el reemplazo y los residuos. En POINT trabajamos con proveedores que nos suministran materiales reciclados procedentes de fibras, hilo y tela y con empresas que convierten

In 1920, José Pons Pedro returned to his homeland after several years “doing the Americas”. He came back having learned a trade, wicker weaving. And in the Marina Alta area, he found the raw material he needed, wicker. With this material he began to create furniture –a revolution at the time– that combined beauty and durability. Without knowing it, sustainability was already in each of his pieces more than a century ago.

For ten decades, this philosophy has been present in every generation that has passed on the good work of POINT’s founder. The challenge for the third and fourth generations has been to integrate into industrialisation all the wisdom and respect for the land that has marked our history. One of the first lessons learned is that there is nothing more sustainable than a durable piece of furniture that can be passed down from generation to generation. Each of our designs is made to last. Another lesson has been to seek materials that do not have an impact on the environment. At POINT we have developed an in-house design protocol that requires us to work with recyclable components so that they all have a second useful life, ensuring that our manufacturing processes and treatment of the waste generated fulfil the objective of caring for the planet. These are the challenges we have set for each of our designers.

This means that a collection where wood –grade A teak– is the protagonist will have its origin in sustainably managed forests. These woods contain a high level of natural oil and gums, making them highly flexible and durable. Their natural oil is combined with an antiseptic resin in the wood that enhances the beauty of each piece over time. Materials such as aluminium, which is very strong and 100% recyclable, are used. It can be transformed and put back into the production cycle. The choice of upholstery fabrics obeys not only aesthetic but also functional and environmental criteria. They are washable, reversible, hard wearing and high quality, which limits replacement and waste. At POINT we work with suppliers that provide us with recycled materials from fibres, yarn and fabric and with companies that convert leftover

los sobrantes de tela en materiales nuevos. Los tejidos que empleamos en nuestras piezas cuentan con certificados que acreditan el uso de sustancias no dañinas para la salud o el entorno. Disponemos también de certificados de calidad de nuestros productos, como el Certificado de Ensayo de AIDIMA (el Instituto Tecnológico del Mueble). Se reciclan al 100% el cartón, el plástico y las espumas que se utilizan en el proceso de fabricación.

Precusores en el consumo responsable y el cuidado de la naturaleza, hace casi dos décadas transformamos nuestra sede central de Jalón en una planta de producción de energía limpia. El sol nos ha permitido ser autosuficientes energéticamente y generar más energía de la que necesitamos. Con una producción fotovoltaica de 371.000 kilovatios al año, conseguimos evitar la emisión a la atmósfera de 138 toneladas de dióxido de carbono (CO2), una cantidad equivalente a la que generan 50 coches de media durante un año.

fabric into new materials. The fabrics we use in our pieces have certificates guaranteeing the use of substances that are safe for human health and the environment. We also hold quality certificates for our products, such as the AIDIMA (Furniture Technology Institute) Test Certificate. The cardboard, plastic and foams used in the manufacturing process are 100% recycled.

As some of the earliest proponents of responsible consumption and caring for nature, almost two decades ago we transformed our headquarters in Jalón into a clean energy production plant. The sun has enabled us to be energy self-sufficient and to generate more energy than we need. With a photovoltaic production of 371,000 kilowatts per year, we achieved 138 tonnes worth of carbon dioxide (CO2) emissions savings, an amount equivalent to that generated by an average of 50 cars over one year.



DESIGNER

Mario Ruiz

Mario Ruiz (Alicante, 1965) es el maestro de la línea limpia y uno de los diseñadores industriales más prolíficos. Ha hecho de la sencillez y la funcionalidad su seña de identidad. En su obra hay un marcado carácter sensorial, con materiales que dibujan la luz y el aroma del Mediterráneo. Su trabajo ha sido objeto de exposiciones y monografías por todo el mundo. Ha recibido más de 50 premios en Europa y Estados Unidos. En nuestro país, en 2016, recogió el Premio Nacional de Diseño de manos del Rey Felipe VI.

Mario Ruiz (Alicante, 1965) is the master of clean lines and one of the most prolific industrial designers. He has made simplicity and functionality his hallmark. His work is distinctly sensorial, with materials suggestive of the light and flavour of the Mediterranean. His designs have been the subject of exhibitions and monographs all over the world and have received more than 50 awards in Europe and the United States. In Spain, he received the 2016 National Design Award from King Felipe VI.



ORIGIN

Origin

Mario Ruiz

El triunfo de la simplicidad

“Origin parece una colección sencilla y lo es, es lo que busca su diseño y lo pone en valor porque, pese a lo que pudiera parecer, lo sencillo y lo simple es lo más difícil de diseñar”, afirma Mario Ruiz. El diseñador fiel al “menos es más” que acuñó el arquitecto y unos de los padres de la arquitectura moderna, Mies van der Rohe, demuestra con unos sencillos trazos, que con un discreto gesto se puede llegar muy lejos.

Todas las piezas que conforman la colección son apilables ya sean mesas, sofás, tumbonas, butacas o sillas. Además, se adaptan a diferentes composiciones con suma facilidad entre ellas, creando zonas de salón, comedor, relax... Las dimensiones son precisas y han sido estudiadas en profundidad para permitir crear composiciones tanto para espacios de pocos metros como para grandes superficies. Tres claves que hacen de Origin un aliado versátil tanto para el hogar como para proyectos de contract o de hospitality.

La estructura de todas las piezas es de aluminio pintado en polvo. Este material se escogió por su durabilidad y porque es 100% reciclable al final de su vida útil. La superficie de los asientos y respaldos de sillas o tumbonas es de texiline y los cojines están tapizados en tejidos de alta resistencia garantizada a la exposición solar. Manteniendo nuestra apuesta por la sostenibilidad, hemos buscado que Origin sea una colección duradera tanto en materiales como en diseño –más allá de tendencias efímeras–, porque sin durabilidad no hay sostenibilidad.

The triumph of simplicity

“Origin looks like a simple collection, and it is. In fact, that’s the intention behind its design and is its defining feature because, despite what one may think, simple, straightforward pieces are the most difficult thing to design”, says Mario Ruiz. Faithful to the idea of “less is more” coined by the architect Mies van der Rohe, one of the fathers of modern architecture, the designer demonstrates with a few simple lines that a discreet gesture can go a long way.

All the pieces in the collection can be stacked, whether they are tables, sofas, loungers, armchairs or chairs. They also fit into different compositions with great ease, creating living, dining and relaxing areas... The dimensions are precise and have been carefully studied so that it is possible to create compositions either for spaces measuring just a few metres or for large areas. These three key elements make Origin a versatile ally both for the home and for contract or hospitality projects.

The structure of all the pieces is made from powder painted aluminium finished. This material was chosen for its durability and because it is 100% recyclable at the end of its useful life. The surface of the seats and backs of the chairs and loungers is made from texiline and the cushions are upholstered in fabrics with guaranteed resistance against sun exposure. In line with our ongoing commitment to sustainability, we have sought to make Origin a long-lasting collection in terms of both materials and design –beyond ephemeral trends– because without durability there is no sustainability.







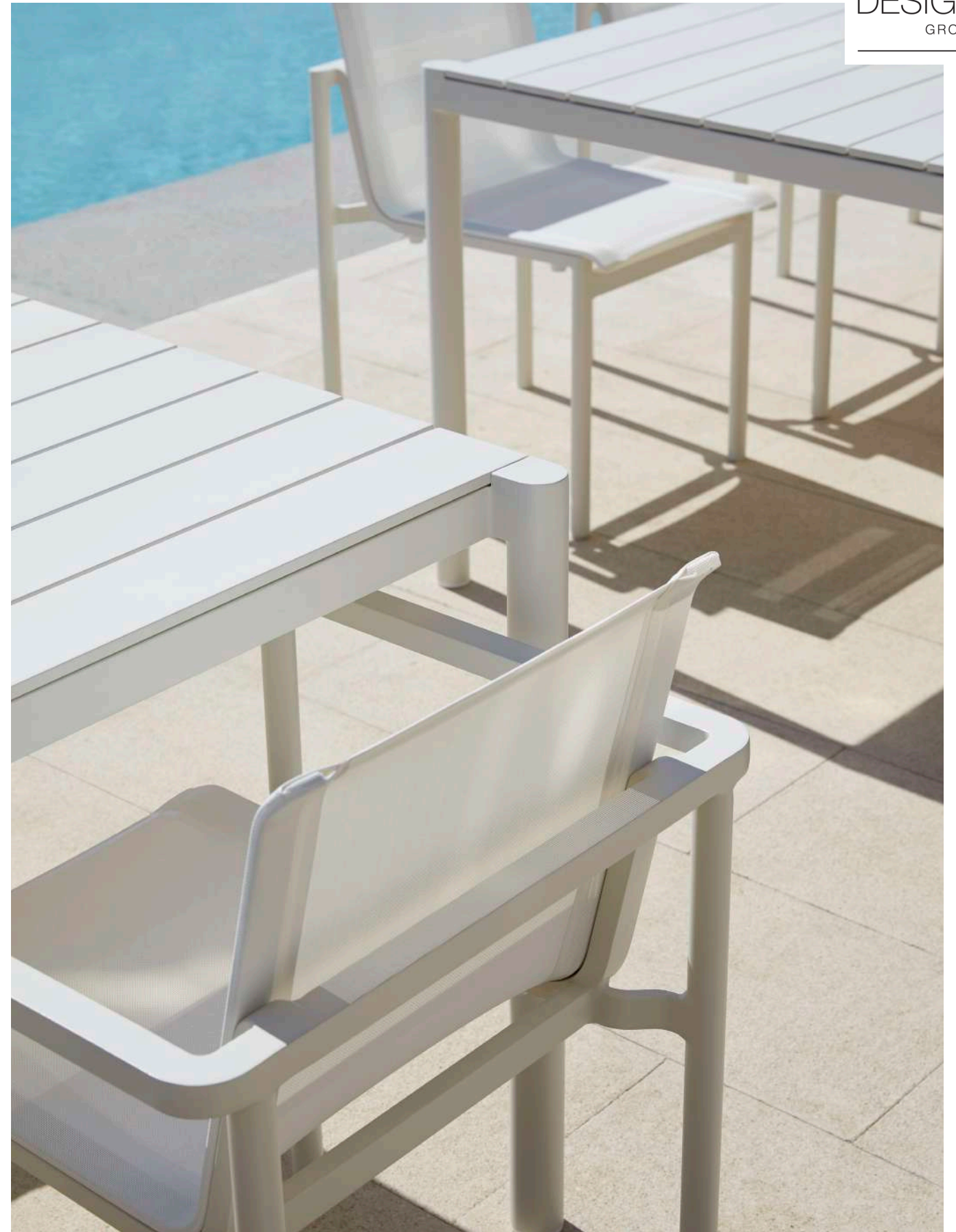























TECHNICAL DETAILS



Origin

SILLA SIDE CHAIR

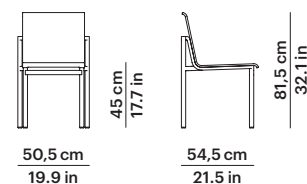

Ref. 79101

Peso Weight 8,9 Kg 19.6 lb (1 pc)
m³ 0,30 m³ (1 pc)
25,6 Kg 56.4 lb (4 pcs)
0,46 m³ (4 pcs)



Ref. 79106

Peso Weight 10,3 Kg 22.7 lb (1 pc)
m³ 0,34 m³ (1 pc)
31,2 Kg 68.8 lb (4 pcs)
0,52 m³ (4 pcs)

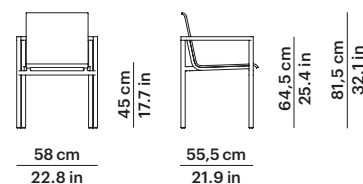

TUMBONA CHAISE

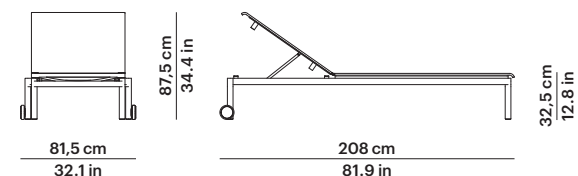

Ref. 79195

Peso Weight 23,8 Kg 52.5 lb (1 pc)
m³ 41 Kg 90.4 lb (2 pcs)
0,66 m³ (1 pc)
0,66 m³ (2 pcs)



Materiales y acabados Materials and finishes

Estructura
Frame
Aluminio pintado en polvo
Powder coated aluminium

Acabados Estructuras Frame Finishes



Crema 34
Cream 34



Gris
Metalizado 56
Gunmetal
Grey 56

Acabados Telas Fabric Finishes

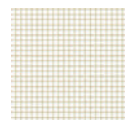

Batyline 35

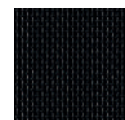

Batyline 57

Origin

SILLÓN LOUNGE CHAIR

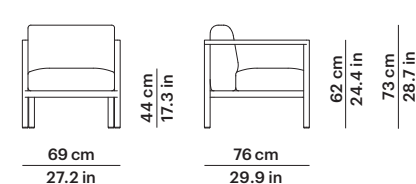

Ref. 79145

Peso Weight 17,3 Kg 38.1 lb (1 pc)
m³ 26 Kg 57.3 lb (2 pcs)
0,49 m³ (1 pc)
0,55 m³ (2 pcs)

Cuadrantes 1 (55x23 cm)
Scatter cushions 1 (21.7x9.1 in)

SOFÁ 2 MODULAR BRAZO DERECHO RIGHT ARM SECTIONAL SOFA 2

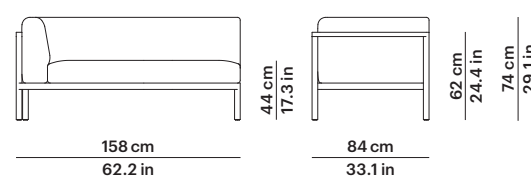

Ref. 79144

Peso Weight 32,8 Kg 72.3 lb
m³ 1,18 m³
Cuadrantes 2 (40x40 cm)
Scatter cushions 2 (15.8x15.8 in)

Materiales y acabados Materials and finishes

Estructura
Frame
Aluminio pintado en polvo
Powder coated aluminium

Acabados Estructuras Frame Finishes



Crema 34
Cream 34



Gris
Metalizado 56
Gunmetal
Grey 56

SOFA 2 SOFA 2

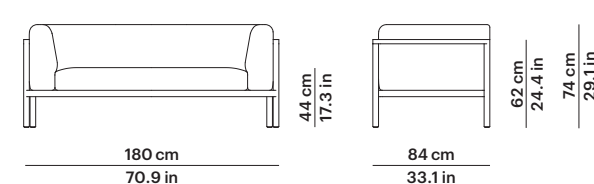

Ref. 79147

Peso Weight 39 Kg 86 lb
m³ 1,34 m³
Cuadrantes 4 (40x40 cm)
Scatter cushions 4 (15.8x15.8 in)

SOFÁ 2 MODULAR BRAZO IZQUIERDO LEFT ARM SECTIONAL SOFA 2

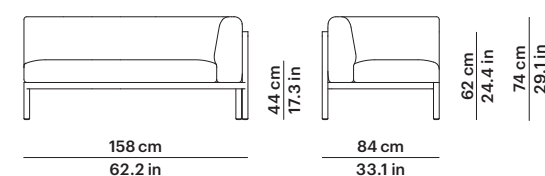

Ref. 79146

Peso Weight 32,8 Kg 72.3 lb
m³ 1,18 m³
Cuadrantes 2 (40x40 cm)
Scatter cushions 2 (15.8x15.8 in)

Origin

SOFÁ 3 MODULAR BRAZO DERECHO RIGHT ARM SECTIONAL SOFA 3

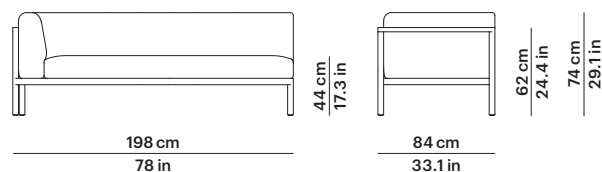

Ref. 79142

Peso Weight 45,6 Kg 100.5 lb
m³ 1,47 m³
Cuadrantes 3 (40x40 cm)
Scatter cushions 3 (15.8x15.8 in)

SOFÁ 3 MODULAR BRAZO IZQUIERDO LEFT ARM SECTIONAL SOFA 3

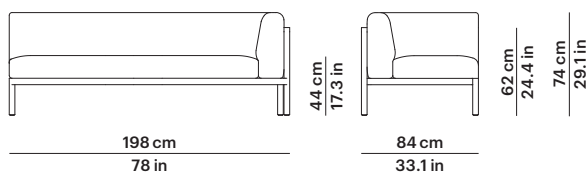

Ref. 79143

Peso Weight 45,6 Kg 100.5 lb
m³ 1,47 m³
Cuadrantes 3 (40x40 cm)
Scatter cushions 3 (15.8x15.8 in)

SOFÁ 3 SOFA 3

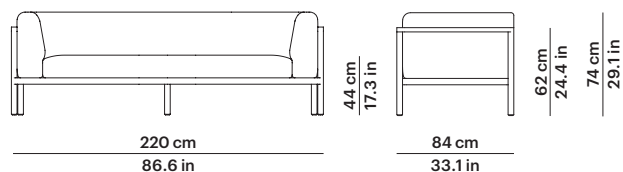

Ref. 79149

Peso Weight 46,8 Kg 103.2 lb
m³ 1,63 m³
Cuadrantes 5 (40x40 cm)
Scatter cushions 5 (15.8x15.8 in)

Materiales y acabados Materials and finishes

Estructura
Frame
Aluminio pintado en polvo
Powder coated aluminium

Acabados Estructuras Frame Finishes

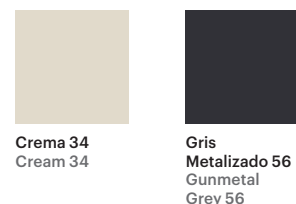

Origin

MESA RINCÓN CUADRADA SQUARE SIDE TABLE

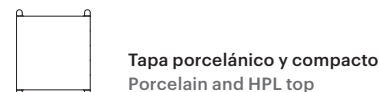
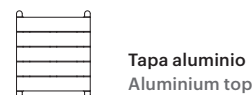
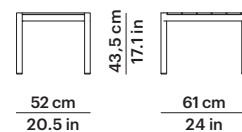

Ref. 79156

Peso Weight 9,2 Kg con tapa aluminio
20.3 lb with aluminium top
15,3 Kg con tapa porcelánico
33.8 lb with porcelain top
11,3 Kg con tapa compacto
24.9 lb with HPL top
m³ 0,19 m³

MESA CENTRO CUADRADA SQUARE COFFEE TABLE

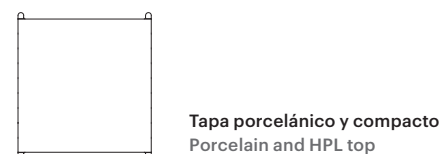
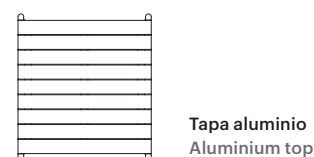
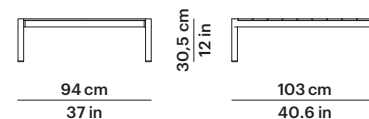

Ref. 79153

Peso Weight 22,8 Kg con tapa aluminio
50.3 lb with aluminium top
42,2 Kg con tapa porcelánico
93.1 lb with porcelain top
29 Kg con tapa compacto
63.9 lb with HPL top
m³ 0,40 m³

MESA CENTRO RECTANGULAR RECTANGULAR COFFEE TABLE

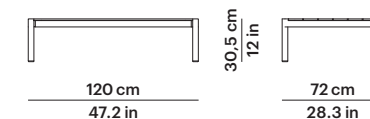

Ref. 79154

Peso Weight 17 Kg con tapa aluminio
37.5 lb with aluminium top
33,6 Kg con tapa porcelánico
74 lb with porcelain top
22,3 Kg con tapa compacto
49.2 lb with HPL top
m³ 0,36 m³

Origin

MESA COMEDOR CUADRADA SQUARE DINING TABLE

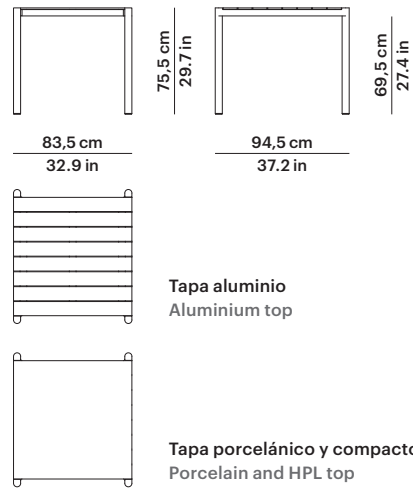

Ref. 79110

Peso Weight 21,2 Kg con tapa aluminio
46.7 lb with aluminium top
36,6 Kg con tapa porcelánico
80.7 lb with porcelain top
26,2 Kg con tapa compacto
57.7 lb with HPL top

m³ 0,73 m³

MESA COMEDOR RECTANGULAR RECTANGULAR DINING TABLE

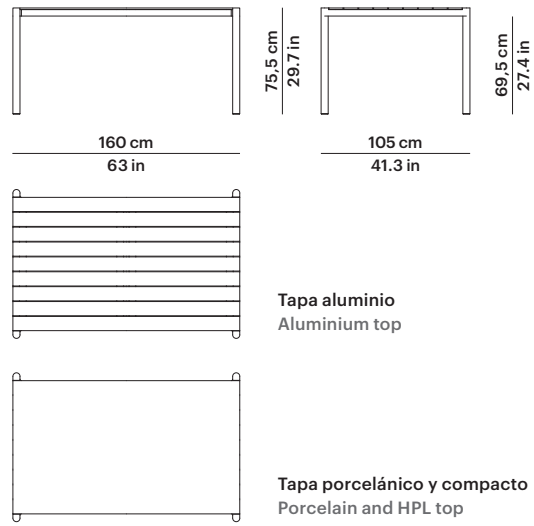

Ref. 79109

Peso Weight 33,4 Kg con tapa aluminio
73.6 lb with aluminium top
66,4 Kg con tapa porcelánico
146.4 lb with porcelain top
43,9 Kg con tapa compacto
96.7 lb with HPL top

m³ 1,5 m³

Origin

MESA COMEDOR RECTANGULAR RECTANGULAR DINING TABLE

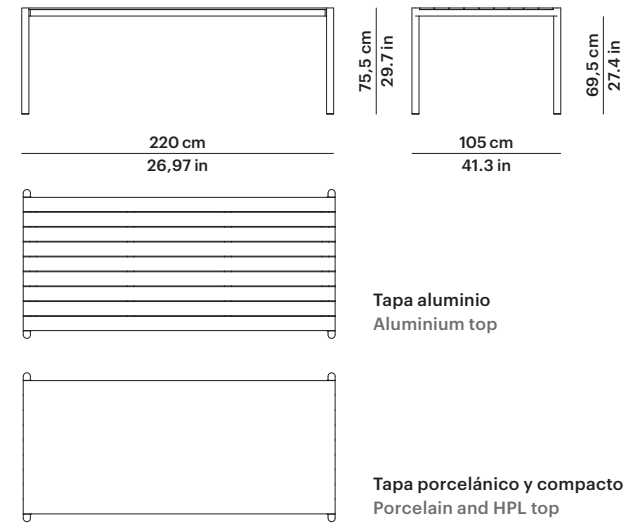





Ref. 79108

Peso Weight 46,4 Kg con tapa aluminio
102.3 lb with aluminium top
93,2 Kg con tapa porcelánico
205.4 lb with porcelain top
62,2 Kg con tapa compacto
137 lb with HPL top

m³ 2,04 m³

SÍMBOLOS SIMBOLS

-  Apilable
Stacking
-  Patas regulables
Adjustable legs
-  Abatible
Swing
-  Ruedas
Wheels

Materiales y acabados Materials and finishes

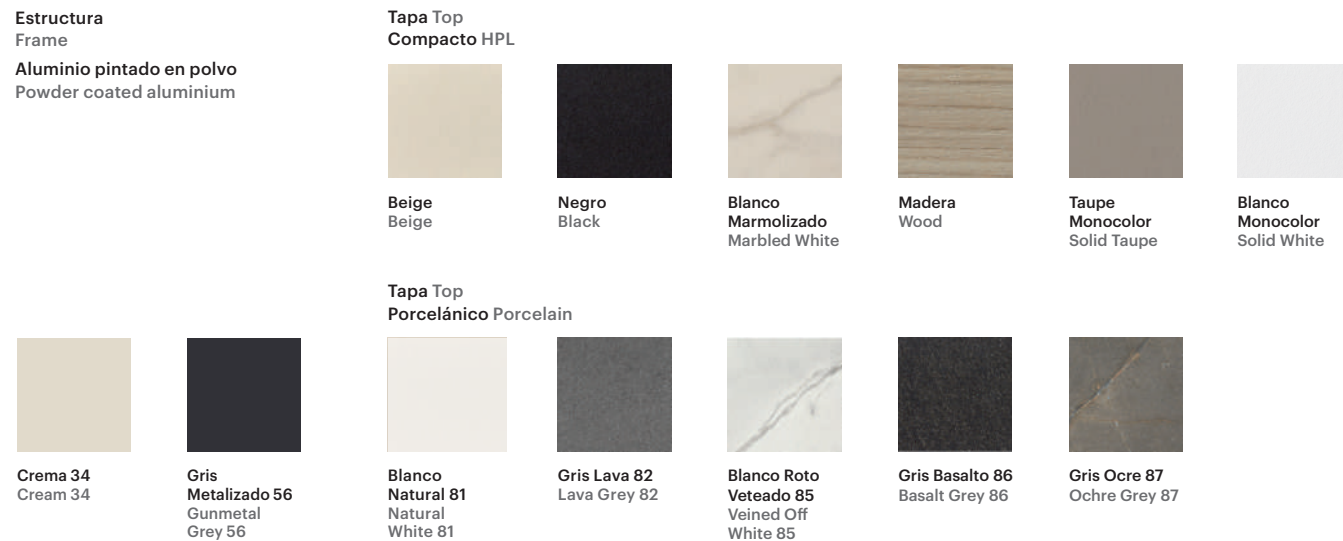

Materiales y acabados Materials and finishes

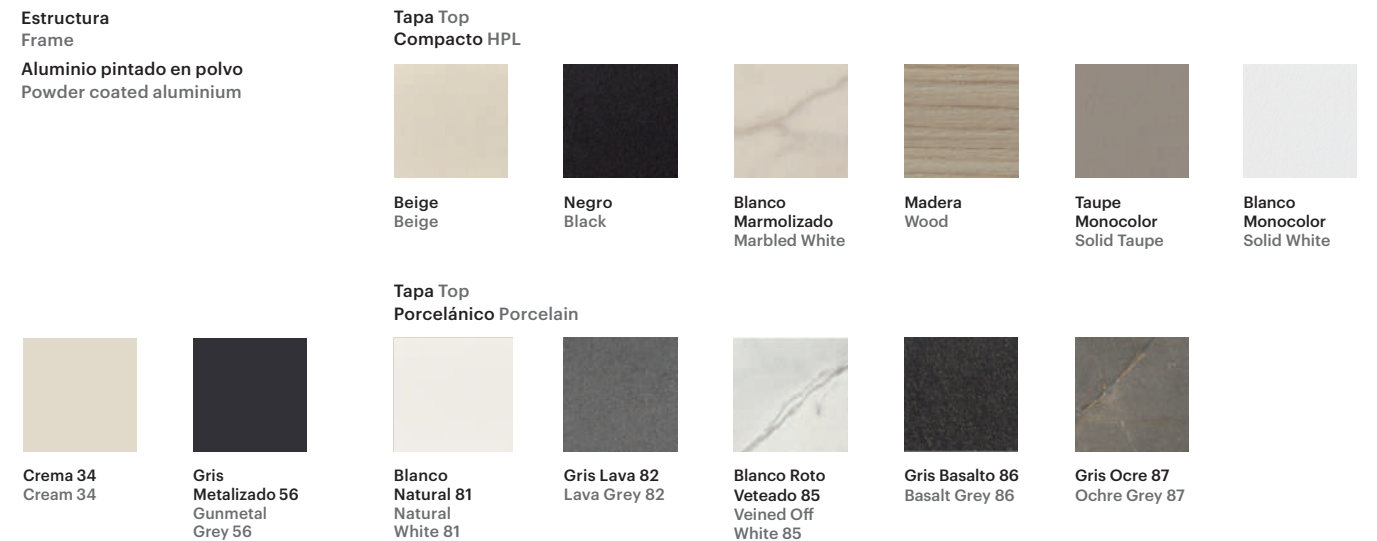

Composiciones Sugeridas Suggested Compositions

Composición 1 Composition 1



Uds. Units	Ref.	Descripción Description
1	79142	Sofá 3 modular brazo derecho Right arm sectional sofa 3
1	79144	Sofá 2 modular brazo derecho Right arm sectional sofa 2
1	79146	Sofá 2 modular brazo izquierdo Left arm sectional sofa 2
1	79153	Mesa centro cuadrada tapa porcelánico Square coffee table porcelain top

Composición 2 Composition 2



Uds. Units	Ref.	Descripción Description
1	79144	Sofá 2 modular brazo derecho Right arm sectional sofa 2
1	79146	Sofá 2 modular brazo izquierdo Left arm sectional sofa 2
1	79154	Mesa centro rectangular tapa porcelánico Rectangular coffee table porcelain top

Composición 3 Composition 3



Uds. Units	Ref.	Descripción Description
1	79142	Sofá 3 modular brazo derecho Right arm sectional sofa 3
1	79143	Sofá 3 modular brazo izquierdo Left arm sectional sofa 3
1	79144	Sofá 2 modular brazo derecho Right arm sectional sofa 2
1	79146	Sofá 2 modular brazo izquierdo Left arm sectional sofa 2
1	79153	Mesa centro cuadrada tapa aluminio Square coffee table aluminium top

Composición 4 Composition 4



Uds. Units	Ref.	Descripción Description
1	79142	Sofá 3 modular brazo derecho Right arm sectional sofa 3
1	79143	Sofá 3 modular brazo izquierdo Left arm sectional sofa 3
2	79153	Mesa centro cuadrada tapa porcelánico Square coffee table porcelain top

Composición 5 Composition 5



Uds. Units	Ref.	Descripción Description
1	79144	Sofá 2 modular brazo derecho Right arm sectional sofa 2
1	79146	Sofá 2 modular brazo izquierdo Left arm sectional sofa 2
4	79145	Sillón Lounge chair
2	79153	Mesa centro cuadrada tapa aluminio Square coffee table aluminium top

Composición 6 Composition 6



Uds. Units	Ref.	Descripción Description
1	79144	Sofá 2 modular brazo derecho Right arm sectional sofa 2
2	79146	Sofá 2 modular brazo izquierdo Left arm sectional sofa 2
1	79153	Mesa centro cuadrada tapa aluminio Square coffee table aluminium top



Page 19

Ref. 79101 Silla | Side Chair C/56.

Ref. 79106 Sillón Comedor | Armchair C/56.

Ref. 79109 Mesa Comedor Rec. 160 x 105 x 75,5 cm | Rectangular Dining Table 63 x 41.3 x 29.7 in C/56 Tapa Aluminio / Aluminium Top.

Ref. 79108 Mesa Comedor Rec. 220 x 105 x 75,5 cm | Rectangular Dining Table 86.6 x 41.3 x 29.7 in C/56 Tapa Aluminio / Aluminium Top.

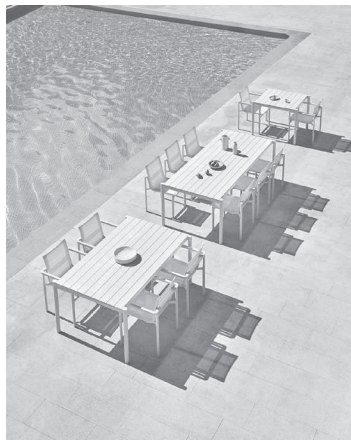

Page 21

Ref. 79101 Silla | Side chair C/34.

Ref. 79106 Sillón comedor | Armchair C/34.

Ref. 79110 Mesa Comedor Cuadrada 83,5 x 94,5 x 75,5 cm | Square Dining Table 32.9 x 37.2 x 29.7 in C/34 Tapa Aluminio / Aluminium Top.

Ref. 79109 Mesa Comedor Rectangular 160 x 105 x 75,5 cm | Rectangular Dining Table 63 x 41.3 x 29.7 in C/34 Tapa Aluminio / Aluminium Top.

Ref. 79108 Mesa Comedor Rectangular 220 x 105 x 75,5 cm | Rectangular Dining Table 86.6 x 41.3 x 29.7 in C/34 Tapa Aluminio / Aluminium Top.



Page 22

Ref. 79101 Silla | Side Chair C/56.

Ref. 79106 Sillón Comedor | Armchair C/56.

Ref. 79108 Mesa Comedor Rec. 220 x 105 x 75,5 cm | Rectangular Dining Table 86.6 x 41.3 x 29.7 in C/56 Tapa Porcelánico Gris Basalto 86 / Porcelain 86 Basalt Grey Top.

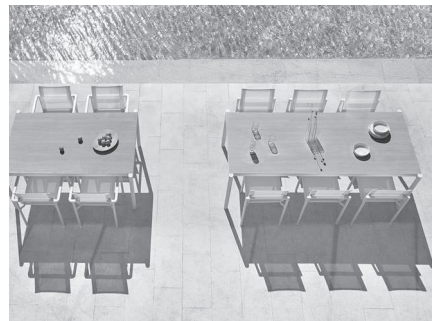

Page 26

Ref. 79101 Silla | Side Chair C/34.

Ref. 79106 Sillón Comedor | Armchair C/34.

Ref. 79109 Mesa Comedor Rec. 160 x 105 x 75,5 cm | Rectangular Dining Table 63 x 41.3 x 29.7 in C/34 Tapa Compacto Madera / HPL Wood Top.

Ref. 79108 Mesa Comedor Rec. 220 x 105 x 75,5 cm | Rectangular Dining Table 86.6 x 41.3 x 29.7 in C/34 Tapa Compacto Madera / HPL Wood Top.



Page 31

Ref. 79195 Tumbona | Chaise C/34.

Ref. 79156 Mesa Rincón Cuadrada | Square Side Table C/34.



Page 32

Ref. 79145 Sillón | Lounge Chair C/56. Tela/ Fabric 1280 & Cuadrante/Cushion 1253.

Ref. 79144 Sofá 2 Mod. Brazo Dcho. | Right Arm Sectional Sofa 2 C/56. Tela/Fabric 1280 & Cuadrante/Cushion 1253.

Ref. 79146 Sofá 2 Mod. Brazo Izq. | Left Arm Sectional Sofa 2 C/56. Tela/Fabric 1280 & Cuadrante/Cushion 1253.

Ref. 79142 Sofá 3 Mod. Brazo Dcho. | Right Arm Sectional Sofa 3 C/56. Tela/Fabric 1280 & Cuadrante/Cushion 1253.

Ref. 79154 Mesa Centro Rect. 120 x 72 x 30,5 cm | Rect. Coffee Table 47.2 x 28.3 x 12 in C/56 Tapa Aluminio / Aluminium Top.

Ref. 79156 Mesa Rincón Cuadrada 52 x 61 x 43,5 cm | Square Side Table 20.5 x 24 x 17.1 in C/56 Tapa Aluminio / Aluminium Top.



Page 34

Ref. 79145 Sillón | Lounge Chair C/56. Tela/ Fabric 1280 & Cuadrante/Cushion 1279.



Page 35

Ref. 79144 Sofá 2 Mod. Brazo Dcho. | Right Arm Sectional Sofa 2 C/56. Tela/Fabric 1280 & Cuadrante/Cushion 1279.

Ref. 79146 Sofá 2 Mod. Brazo Izq. | Left Arm Sectional Sofa 2 C/56. Tela/Fabric 1280 & Cuadrante/Cushion 1279.

Ref. 79142 Sofá 3 Mod. Brazo Dcho. | Right Arm Sectional Sofa 3 C/56. Tela/Fabric 1280 & Cuadrante/Cushion 1279.

Ref. 79154 Mesa Centro Rect. 120 x 72 x 30,5 cm | Rect. Coffee Table 47.2 x 28.3 x 12 in C/56 Tapa Porcelánico Gris Basalto 86 / Porcelain 86 Basalt Grey Top.

Ref. 79156 Mesa Rincón Cuadrada 52 x 61 x 43,5 cm | Square Side Table 20.5 x 24 x 17.1 in C/56 Tapa Porcelánico Gris Basalto 86 / Porcelain 86 Basalt Grey Top.



Page 36

Ref. 79145 Sillón | Lounge Chair C/56. Tela/ Fabric 1279 & Cuadrante/Cushion 1280.

Ref. 79144 Sofá 2 Mod. Brazo Dcho. | Right Arm Sectional Sofa 2 C/56. Tela/Fabric 1279 & Cuadrante/Cushion 1280.

Ref. 79146 Sofá 2 Mod. Brazo Izq. | Left Arm Sectional Sofa 2 C/56. Tela/Fabric 1279 & Cuadrante/Cushion 1280.

Ref. 79143 Sofá 3 Mod. Brazo Izq. | Left Arm Sectional Sofa 3 C/56. Tela/Fabric 1279 & Cuadrante/Cushion 1280.

Ref. 79153 Mesa Centro Cuadrada 94 x 103 x 30,5 cm | Square Coffee Table 37 x 40.6 x 12 in C/56 Tapa Porcelánico Gris Basalto 86 / Porcelain 86 Basalt Grey Top.



Page 38

Ref. 79144 Sofá 2 Mod. Brazo Dcho. | Right Arm Sectional Sofa 2 C/34. Tela/Fabric 1269 & Cuadrante/Cushion 1088.

Ref. 79146 Sofá 2 Mod. Brazo Izq. | Left Arm Sectional Sofa 2 C/34. Tela/Fabric 1269 & Cuadrante/Cushion 1088.

Ref. 79149 Sofá 3 | Sofa 3 C/34 Tela/Fabric 1269 & Cuadrante/Cushion 1088.

Ref. 79154 Mesa Centro Rect. 120 x 72 x 30,5 cm | Rect. Coffee Table 47.2 x 28.3 x 12 in C/34 Tapa Porcelánico Blanco Natural 81/ Porcelain 81 Natural White Top.



Page 40

Ref. 79145 Sillón | Lounge Chair C/34. Tela/ Fabric 1280 & Cuadrante/Cushion 1273.

Ref. 79154 Mesa Centro Rect. 120 x 72 x 30,5 cm | Rect. Coffee Table 47.2 x 28.3 x 12 in C/34 Tapa Aluminio / Aluminium Top.



Page 44

Ref. 79149 Sofá 3 | Sofa 3 C/34 Tela/Fabric 1269 & Cuadrante/Cushion 1088.

Ref. 79154 Mesa Centro Rect. 120 x 72 x 30,5 cm | Rect. Coffee Table 47.2 x 28.3 x 12 in C/34 Tapa Porcelánico Blanco Natural 81/ Porcelain 81 Natural White Top.



Page 46

Ref. 79101 Silla | Side chair C/34.

Ref. 79106 Sillón comedor | Armchair C/34.

Ref. 79110 Mesa Comedor Cuadrada 83,5 x 94,5 x 75,5 cm | Square Dining Table 32.9 x 37.2 x 29.7 in C/34 Tapa Porcelánico Blanco Roto Veteado 85/ Porcelain 85 Veined Off White.



Page 47

Ref. 79147 Sofá 2 | Sofa 2 C/34. Tela/Fabric 1271 & Cuadrante/Cushion 1278 & 1271.

Ref. 79149 Sofá 3 | Sofa 3 C/34 Tela/Fabric 1271 & Cuadrante/Cushion 1278 & 1271.

Ref. 79154 Mesa Centro Rect. 120 x 72 x 30,5 cm | Rect. Coffee Table 47.2 x 28.3 x 12 in C/34 Tapa Aluminio / Aluminium Top.

FINISHES AND MAIN- TENANCE

**Porcelánico
Porcelain**

Se trata de un material porcelánico elaborado de 12 mm de espesor.
 Características técnicas: Impermeable y resistente a líquidos, con un nivel de absorción próximo a cero.
 Resistente al rayado y a la abrasión gracias a la dureza de su superficie.
 No se quema en contacto con el fuego ni emite humo ni sustancias tóxicas al ser sometido a altas temperaturas.
 Resistente a cualquier tipo de agente químico de limpieza.
 No desprende sustancias nocivas. Es totalmente apto para el contacto con los alimentos. Certificado NSF.
 Siendo 100% natural, los colores no se desvirtúan cuando el material se expone al sol o a condiciones meteorológicas extremas.
 No desprende ninguna sustancia nociva para el entorno.
 Hasta un 52% de material reciclado en cada tabla. 100% reciclable.
 30 kg/m² en la tabla de 12 mm.
 Módulo de rotura elevado. Resistente a altas cargas de presión y peso.

This is a 12-mm thick porcelain material.
 Technical characteristics: Waterproof and resistant to liquids, with an absorption level close to zero.
 Scratch and abrasion resistant thanks to the hardness of the surface.
 No combustion takes place in contact with fire and no smoke or toxic substances are released when it is subjected to high temperatures.
 Resistant to any type of chemical or cleaning agent. No dangerous substances are given off.
 It is totally apt for contact with foodstuffs. NSF certified. As it is 100% natural, the colours do not fade when exposed to sunlight or subjected to extreme weather conditions. No dangerous substances that may harm the environment are given off.
 Each board contains up to 52% recycled material. 100% recyclable.
 30 kg/m² in a 12 mm board.
 Highly resistant to breakage.
 Resistant to high pressures and loads.

Limpieza y mantenimiento

Tiene una limpieza fácil ya que no pueden penetrar en el material los restos de comida y residuos que se depositen por lo que garantizan una buena higiene.
 Para la mayoría de los casos, sólo bastará con un paño húmedo para limpiarlo.
 Use un paño de microfibra para quitar el polvo de la superficie. Se puede lavar con agua tibia, a la cual se le puede agregar un detergente en la dosis de uso recomendado por el fabricante. (Deben evitarse productos que contengan ácido fluorhídrico y sus derivados). Enjuagar con agua tibia y secar con bayetas o algo similar.

Maintenance and cleaning

Easy to clean, as traces of food and other residues on the surface cannot penetrate the material, thus offering enhanced hygiene; in most cases, it is sufficient to wipe the surface clean with a damp cloth.
 Use a microfibre cloth to dust the surface. To wash, use lukewarm water; a detergent may be added according to the dosage recommended by the manufacturer (products containing hydrofluoric acid and its derivatives should be avoided). Rinse with lukewarm water and dry with a clean cloth.

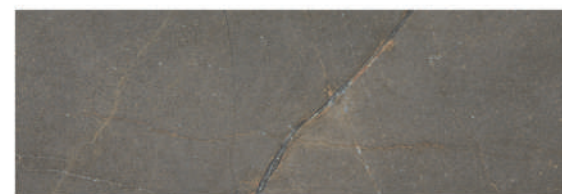

87 Gris Ocre / Ochre Grey



85 Blanco Roto Veteado / Veined Off White



82 Gris Lava / Lava Grey



86 Gris Basalto / Basalt Grey

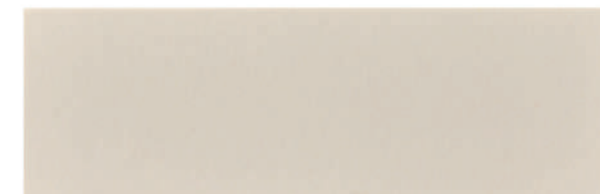

81 Blanco Natural / Natural White

**Compacto
HPL**

Es el material de las tapas de las mesas de algunas colecciones. Se trata de tablero compacto de 10 mm de espesor en calidad standard (CGS) termoendurecido a alta presión en formato 4200x1600 mm con el núcleo compuesto de resinas fenólicas y superficies decorativas impregnadas en resinas melamínicas.

Limpieza y mantenimiento

Las superficies de compacto deben limpiarse con regularidad pero no requieren ningún mantenimiento especial, solo un paño húmedo con agua templada o detergente suave. Se pueden usar perfectamente casi todos los productos de limpieza o desinfectantes domésticos siempre y cuando estos no sean abrasivos o altamente alcalinos.

This is the material used for the table tops of some collections. It is a 10-mm thick, compact board in standard quality (CGS), which was thermoset at high pressure in a 4200x1600 mm mould, with a core made of phenolic resins and decorative surfaces that are impregnated with melamine resins.

Maintenance and cleaning

Surfaces made out of HPL should be cleaned regularly and do not require any special maintenance; just wipe with a damp cloth that has been previously soaked in lukewarm water with a gentle detergent. Almost all kinds of cleaning products can be used without any problem, as long as they are not abrasive or highly alkaline.

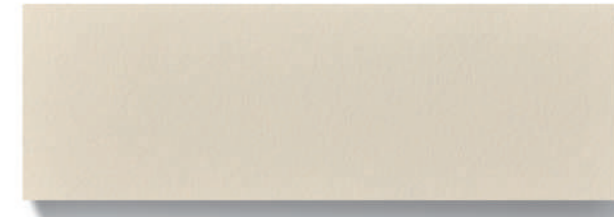

Beige / Beige

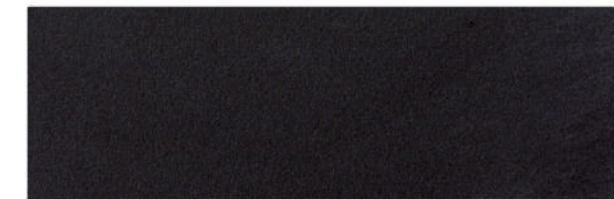

Negro / Black

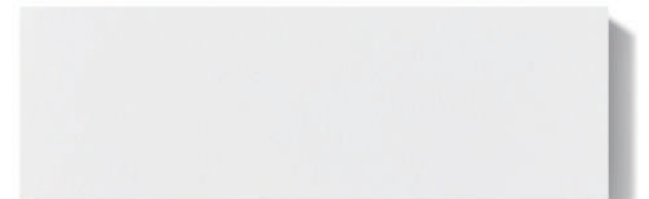

Blanco Monocolor / Solid White



Blanco Marmolizado / Marbled White

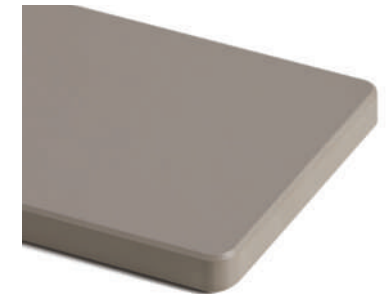

Madera / Wood

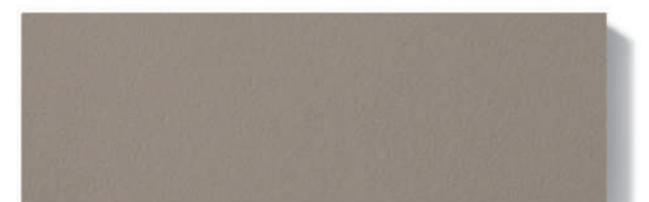

Taupe Monocolor / Solid Taupe

**Aluminio
pintado en polvo
Powder coated
aluminium**

Con resina epóxica como ligante, para incrementar la resistencia a la corrosión, abrasión y a los agentes químicos.

Limpieza y mantenimiento

Utilizaremos bayetas suaves o esponjas que no rayen la superficie y agua con jabón o detergentes neutros diluidos en agua; nunca productos abrasivos. Después se enjuagará con agua limpia y se secará con un paño, para evitar que el detergente afecte al material.

With epoxy resin used as a binder to increase resistance to corrosion, abrasion and chemical agents.

Maintenance and cleaning

Use soft cloths or sponges that will not scratch the surface with soap and water or neutral detergents diluted in water; never use abrasive products. Then rinse with clean water and dry with a cloth to prevent the detergent from affecting the material.

Funda de cubrir

En POINT recomendamos proteger los muebles de exterior con medidas simples y mejorar así su durabilidad. Para ello, creamos la Protective Cover, una funda protectora especial, disponible en color beige, hecha de poliéster con lacado acrílico. Es resistente al agua y cuenta con un tratamiento fungicida en el interior. Además, es repelente a la suciedad y resistente al frío, al calor y a la intemperie. Cada pieza cuenta con su propia funda. Además, tiene un cordón que permite ajustar la funda al mueble, alrededor de la base, para que el viento no pueda levantarla. Para obtener mejores resultados, es conveniente que los muebles, cojines y cuadrantes estén secos antes de cubrirlos para evitar humedad y manchas de moho.

Protective cover

At POINT we recommend simple measures to protect outdoor furniture and make it more durable. For this purpose, we created the Protective Cover, a special protective sheet, available in beige and made from polyester with acrylic lacquer. It is waterproof and treated with a fungicide on the inside. It also repels dirt and is heat, cold and weather resistant. Each piece comes with its own cover. It also includes a tie so you can adjust the cover to the furniture around the base to secure it against the wind. For the best results, the furniture and cushions should be dry before they are covered in order to avoid moisture and mould stains.



34 Crema /
Cream

56 Gris Metalizado /
Gunmetal Grey



FABRICS











Composición: 100% Acrílico teñido en masa
Ancho: 160cm
Acabado: hidrófugo con tratamiento antimanchas.
Solidez a la luz: 7/8
Garantía: 5 años
Tolerancia: valores susceptibles de tolerancia de +/- 5%

Composition: 100% solution dyed acrylic
Width: 160 cm
Finish: water repellent with a stain resistant treatment.
Light fastness: 7/8
Warranty: 5 years
Tolerance: values subject to +/- 5% tolerance

Limpieza y mantenimiento
Maintenance and cleaning

Eliminar la suciedad mediante cepillado o aspirado suave del tejido. Lavar a temperatura máxima de 30° y jabón neutro. No utilizar disolventes ni detergentes abrasivos. No utilizar secadora. Planchado máximo a 150°. No admite lavado en seco.

Remove dirt by softly brushing or vacuuming the fabric. Wash at 30° max. with a mild soap. Do not use solvents or abrasive detergents. Do not tumble dry. Iron up to 150° max. Do not dry clean.

-  Resistente al agua
Water resistant
-  Resistente a las manchas
Stain resistant
-  Resistente al moho
Mould resistant
-  Fuerte y duradero
Durable and strong
-  Aislante
Non-conductive
-  Fácil de limpiar
Easy to clean
-  Protección UV
UV protection
-  Desinfectable
Disinfectable
-  Resistente a los rayos UV
UV resistant
-  Limpiable con lejía
Bleach cleanable

BATYLINE

TEXYLOOP
A CLORELOOP INDUSTRY

Serge Ferrari





Composición: Composite PVC – fibras sintéticas
Ancho: 180cm
Garantía: 5 años
Reciclabilidad: 100% por el sistema Taxyloop
Sistema de gestión de calidad: ISO 9001
Sistema de gestión medioambiental: ISO 14001

Composition: Composite PVC-synthetic fibres
Width: 180 cm
Warranty: 5 years
Recyclability: 100% by Taxyloop method
Quality system: ISO 9001
Environmental system: ISO 14001

Limpieza y mantenimiento
Maintenance and cleaning

Quitar el polvo al tejido con un aspirador o un cepillo suave no metálico. Lavar con un cepillo suave o una esponja utilizando agua jabonosa. Aclarar abundantemente con agua clara (chorro de agua). Dejar que se seque bien el tejido al aire libre en posición desplegada. Si el tejido puede desprenderse de su soporte, la limpieza puede realizarse a máquina a una temperatura no superior a 40°C.

Remove dust from the fabric with a vacuum cleaner or soft, non-metallic brush. Wash with a soft brush or a sponge, using soapy water. Rinse copiously (spray) with clean water. Allow the fabric to air dry completely, well spread out. If the textile can be removed from its base, it may be machine-washed at a temperature no higher than 40°C.

-  Fácil cuidado
Easy care
-  Resistente al desgarro
Tear resistant
-  Resistente a los rayos UV
UV resistant
-  Resistente al moho
Mould resistant
-  Resistente a la deformación
Deformation resistance

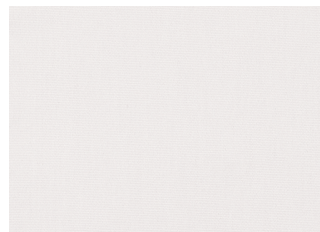

G1 22 20000 C. Martindale



G1 21 20000 C. Martindale



G1 1101 20000 C. Martindale

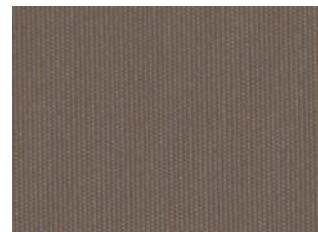

G1 1103 20000 C. Martindale



G3 1276 60000 C. Martindale

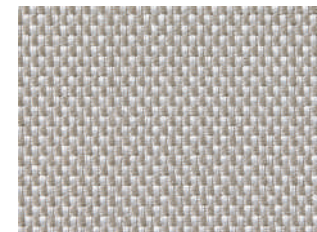

G3 1277 60000 C. Martindale

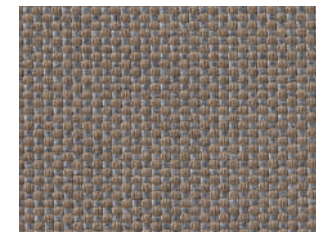

G3 1278 60000 C. Martindale

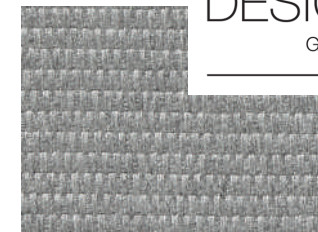

G3 1279 60000 C. Martindale



G1 1119 20000 C. Martindale

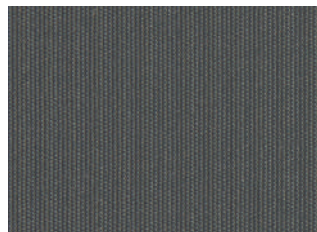

G1 1201 20000 C. Martindale



G2 1086 25000 C. Martindale

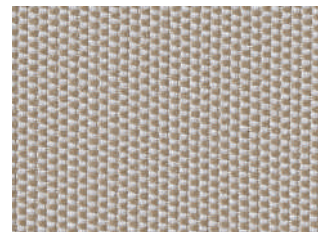

G2 1088 20000 C. Martindale



G3 1280 60000 C. Martindale



G2 1269 20000 C. Martindale

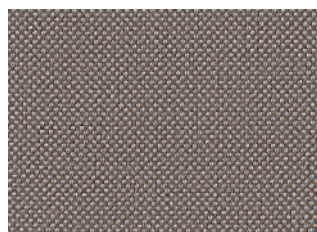

G2 1253 20000 C. Martindale



G2 1255 20000 C. Martindale

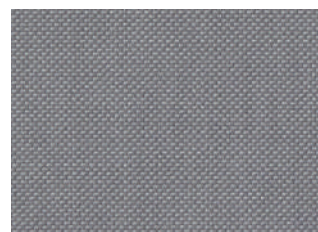

G2 1252 25000 C. Martindale

BATYLINE

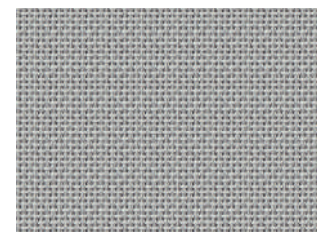

G3 13 120000 C. Martindale

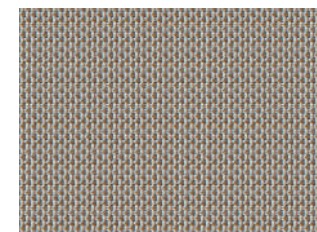

G3 09 120000 C. Martindale

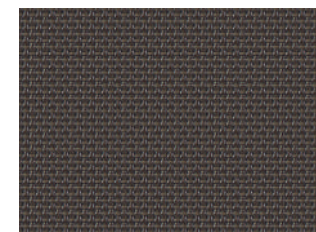

G3 10 120000 C. Martindale

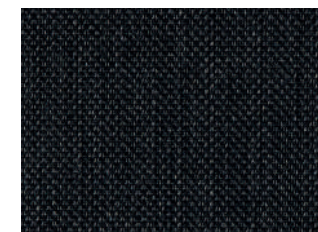

G3 11 120000 C. Martindale



G2 1256 20000 C. Martindale

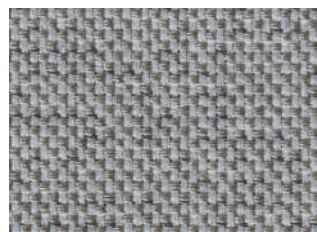

G2 1270 20000 C. Martindale

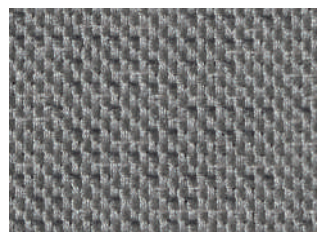

G2 1271 20000 C. Martindale

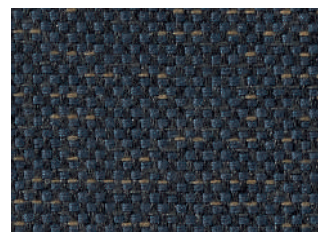

G2 1273 20000 C. Martindale

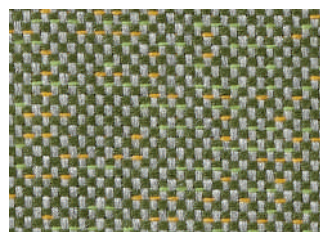

G2 1272 20000 C. Martindale

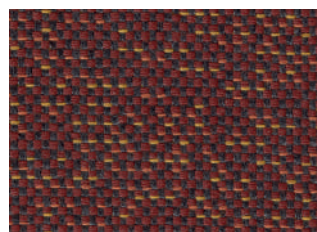

G2 1275 20000 C. Martindale



G2 1268 20000 C. Martindale



G2 1263 20000 C. Martindale

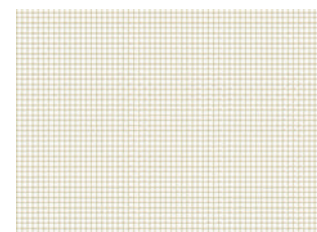

G2 35 120000 C. Martindale

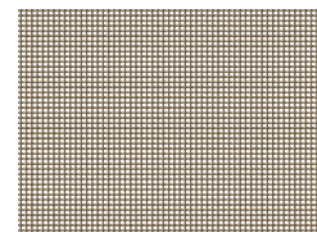

G2 37 120000 C. Martindale

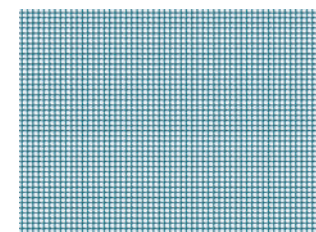

G2 39 120000 C. Martindale

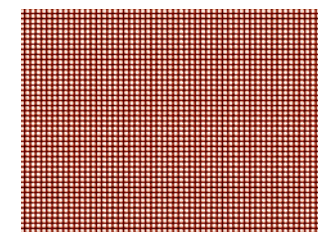

G2 40 120000 C. Martindale



G2 1274 20000 C. Martindale



G2 38 120000 C. Martindale

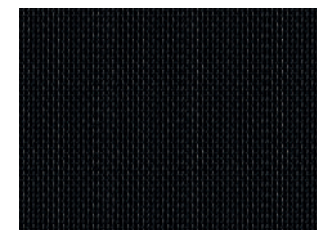

G2 57 120000 C. Martindale

CASA
DESIGN
GROUP