

# Mizu, Flowing *Light*.

design Nicolas Terzani  
terzani.com



**Type |**  
Pendant

**Materials |**  
Clear crystal

**Finishes | Code**

-  White disc/Clear  
OR01S H4 A9 KK
-  White disc/Clear/Silver Dust  
OR01S H4 F4 KK
-  White disc/Clear/Gold  
OR01S E8 A4 KK

**Body |**

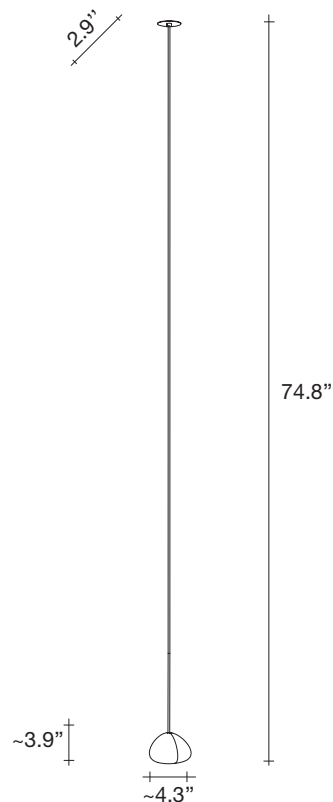

**Recommended Light | Disc |**

120V ~ 50/60Hz

 XENON  
10W G4 12V

---

or

 LED  
2W G4 12V

---

 Dimmable with IGBT  
and TRIAC

---



or on request

 LED integrated  
1,5W 180 lm 3000K  
or optional 2700K

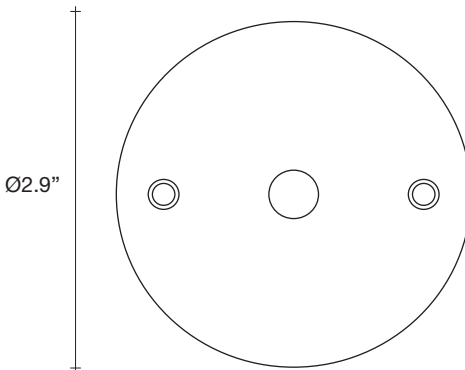
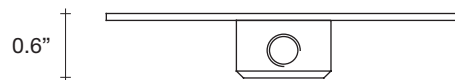
 Not Dimmable



Inspired by the tranquil and mesmerizing light refractions created by water, Mizu is a customizable pendant light from Terzani. Like water droplets, no two Mizu are alike, each crystal shape is unique and made meticulously by hand. Using only the clearest crystal, Mizu perfectly emulates water's refraction of light, casting amazing patterns around the room, reminiscent of flowing water. Also available in gold leaf. Design Nicolas Terzani

 5.5     4.4     6.5" x 6.5" x 8.9"

# Mizu, Flowing *Light*.



design Nicolas Terzani  
terzani.com



**Type |**  
Pendant

**Materials |**  
Clear crystal

**Finishes | Code**

-  Clear  
OR01S H4 A9
-  Clear/Silver Dust  
OR01S H4 F4
-  Clear/Gold  
OR01S E8 A4

Available with White or Brushed nickel canopy

Body |

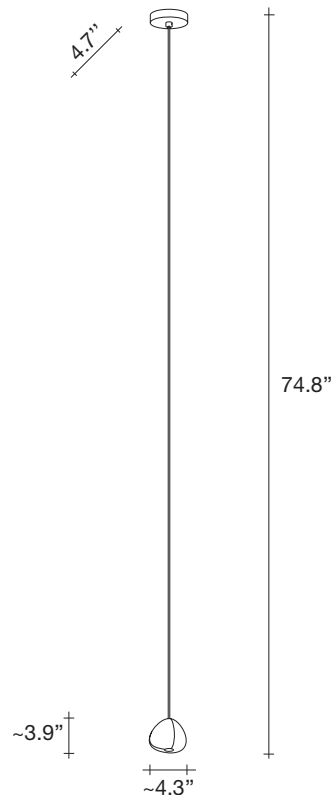

**Recommended Light | Canopy |**

120V ~ 50/60Hz

 XENON  
10W G4 12V

or

 LED  
2W G4 12V

 Dimmable with IGBT and TRIAC

or on request

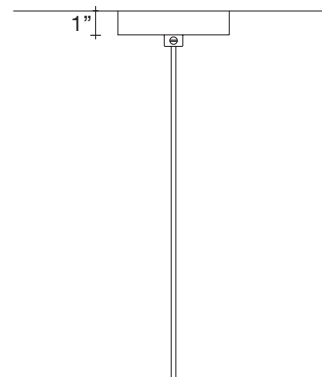
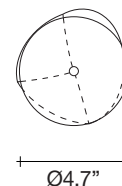

 LED integrated  
1,5W 180 lm 3000K  
or optional 2700K

 Not Dimmable



Inspired by the tranquil and mesmerizing light refractions created by water, Mizu is a customizable pendant light from Terzani. Like water droplets, no two Mizu are alike, each crystal shape is unique and made meticulously by hand. Using only the clearest crystal, Mizu perfectly emulates water's refraction of light, casting amazing patterns around the room, reminiscent of flowing water. Also available in gold leaf. Design Nicolas Terzani



 5.5  4.4  6.5" x 6.5" x 8.9"

CASA DESIGN GROUP  
living outdoor contract

# Mizu, Flowing *Light.*



design Nicolas Terzani  
terzani.com



**Type |**  
Suspension

**Materials |**  
Clear crystal

**Finishes | Code**

-  Clear  
OR03S H4 A9
-  Clear/Silver Dust  
OR03S H4 F4
-  Clear/Gold  
OR03S E8 A4

Available with White or Brushed nickel canopy

Body |

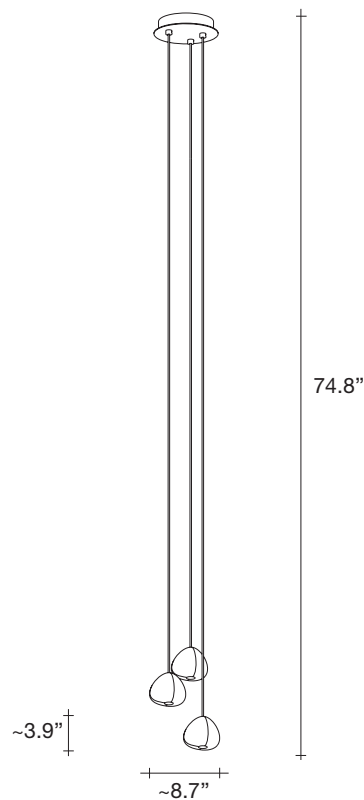

**Recommended Light | Canopy |**

120V ~ 50/60Hz

 XENON  
3 x 10W G4 12V

or

 LED  
3 x 2W G4 12V

 Dimmable with IGBT and TRIAC

or on request

 LED integrated  
3 x 1,5W 540 lm 3000K  
or optional 2700K

 Dimmable with 1-10V  
and Dali system

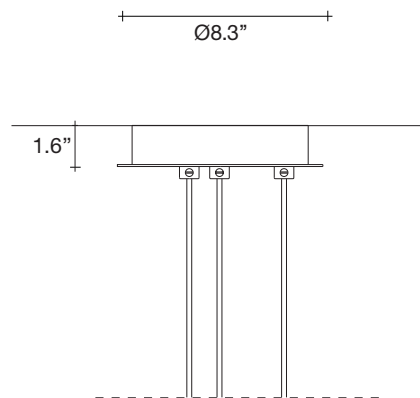
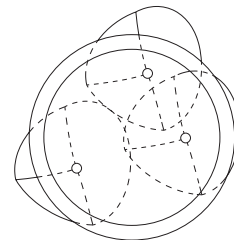

Inspired by the tranquil and mesmerizing light refractions created by water, Mizu is a customizable pendant light from Terzani. Like water droplets, no two Mizu are alike, each crystal shape is unique and made meticulously by hand. Using only the clearest crystal, Mizu perfectly emulates water's refraction of light, casting amazing patterns around the room, reminiscent of flowing water. Also available in gold leaf. Design Nicolas Terzani



CASA DESIGN GROUP  
living outdoor contract

 22

 17.6

 12.2" x 12.2" x 10.2"

# Mizu, Flowing *Light.*



design Nicolas Terzani  
terzani.com



**Type |**  
Suspension

**Materials |**  
Clear crystal

**Finishes | Code**

-  Clear  
OR05S H4 A9
-  Clear/Silver Dust  
OR05S H4 F4
-  Clear/Gold  
OR05S E8 A4

Available with White or Brushed nickel canopy

Body |

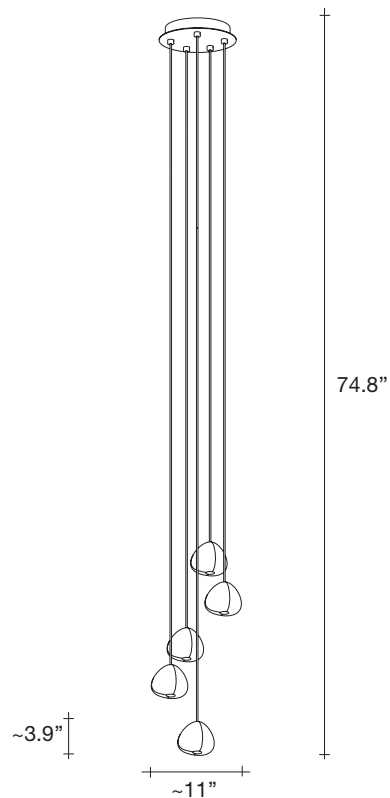

**Recommended Light | Canopy |**

**120V ~ 50/60Hz**

 XENON  
5 x 10W G4 12V

or

 LED  
5 x 2W G4 12V

 Dimmable with IGBT and TRIAC

or on request

 LED integrated  
5 x 1.5W 900 lm 3000K  
or optional 2700K

 Dimmable with 1-10V  
and Dali system

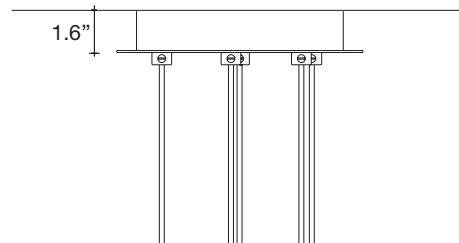
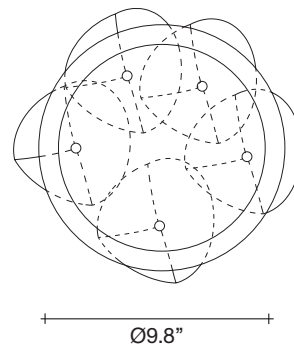

Inspired by the tranquil and mesmerizing light refractions created by water, Mizu is a customizable pendant light from Terzani. Like water droplets, no two Mizu are alike, each crystal shape is unique and made meticulously by hand. Using only the clearest crystal, Mizu perfectly emulates water's refraction of light, casting amazing patterns around the room, reminiscent of flowing water. Also available in gold leaf. Design Nicolas Terzani

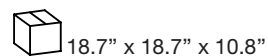



# Mizu, Flowing *Light.*



design Nicolas Terzani  
terzani.com



**Type |**  
Suspension

**Materials |**  
Clear crystal

**Finishes | Code**

-  Clear  
OR07S H4 A9
-  Clear/Silver Dust  
OR07S H4 F4
-  Clear/Gold  
OR07S E8 A4



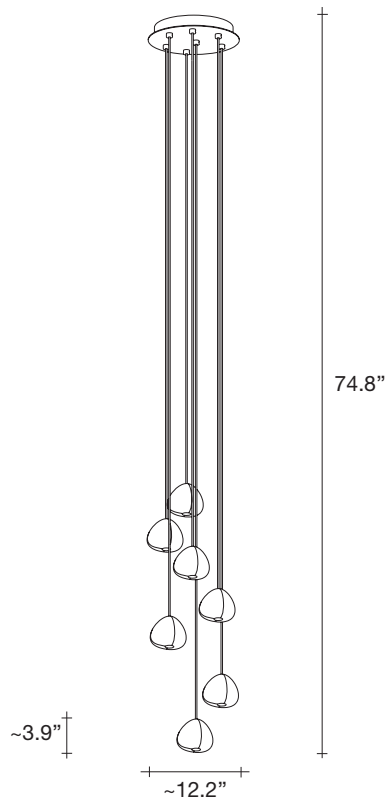

Available with White or Brushed nickel canopy

**Body |**



**Recommended Light | Canopy |**

**120V ~ 50/60Hz**

-  XENON  
7 x 10W G4 12V
- or
-  LED  
7 x 2W G4 12V
-  Dimmable with IGBT and TRIAC
- or on request
-  LED integrated  
7 x 1,5W 1260 lm 3000K or optional 2700K
-  Dimmable with 1-10V and Dali system

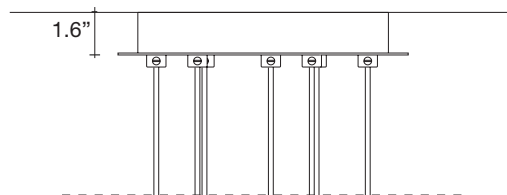
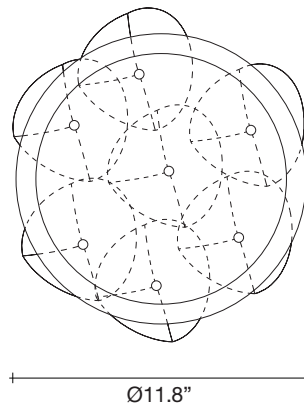

Inspired by the tranquil and mesmerizing light refractions created by water, Mizu is a customizable pendant light from Terzani. Like water droplets, no two Mizu are alike, each crystal shape is unique and made meticulously by hand. Using only the clearest crystal, Mizu perfectly emulates water's refraction of light, casting amazing patterns around the room, reminiscent of flowing water. Also available in gold leaf. Design Nicolas Terzani



 41.8  33  19.7" x 13.8" x 15"

# Mizu, Flowing *Light.*



design Nicolas Terzani  
terzani.com



**Type |**  
Suspension

**Materials |**  
Clear crystal

**Finishes | Code**

-  Clear  
OR15S E8 A9 R
-  Clear/Silver Dust  
OR15S E8 F4 R
-  Clear/Gold  
OR15S E8 A4 R



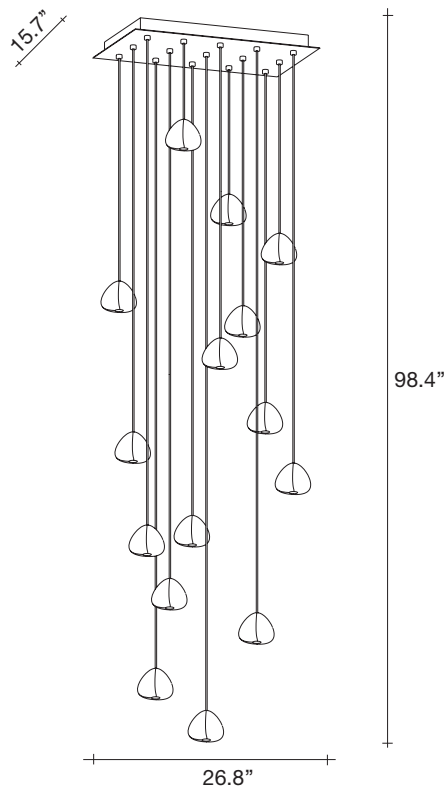

White canopy

Body |



**Recommended Light | Canopy |**

120V ~ 50/60Hz

-  XENON  
15 x 10W G4 12V
- or
-  LED  
15 x 2W G4 12V
-  Dimmable with IGBT and TRIAC
- or on request
-  LED integrated  
15 x 1,5W 2700 lm 3000K or optional 2700K
-  Dimmable with 1-10V and Dali system

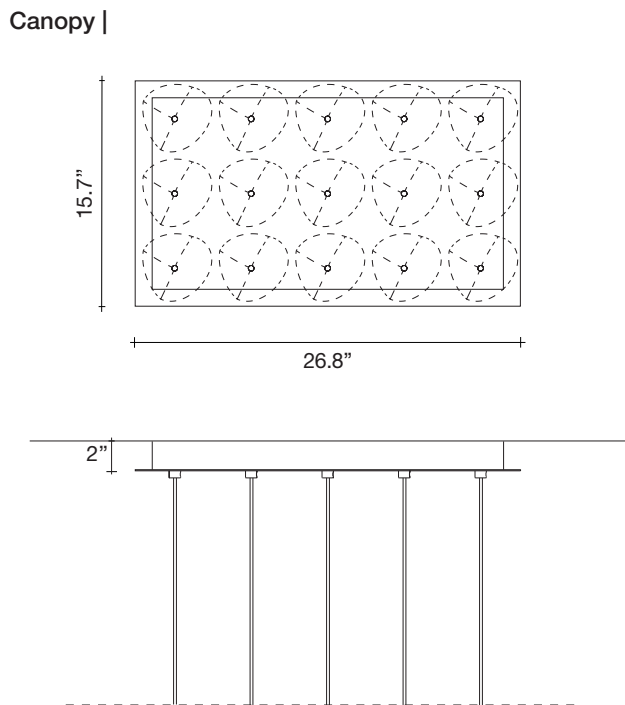

Inspired by the tranquil and mesmerizing light refractions created by water, Mizu is a customizable pendant light from Terzani. Like water droplets, no two Mizu are alike, each crystal shape is unique and made meticulously by hand. Using only the clearest crystal, Mizu perfectly emulates water's refraction of light, casting amazing patterns around the room, reminiscent of flowing water. Also available in gold leaf. Design Nicolas Terzani



 88     79.2     30.3" x 30.3" x 11.8"

# Mizu, Flowing *Light*.



design Nicolas Terzani  
terzani.com



**Type |**  
Suspension

**Materials |**  
Clear crystal

**Finishes | Code**

-  Clear  
OR15S E8 A9 T
-  Clear/Silver Dust  
OR15S E8 F4 T
-  Clear/Gold  
OR15S E8 A4 T



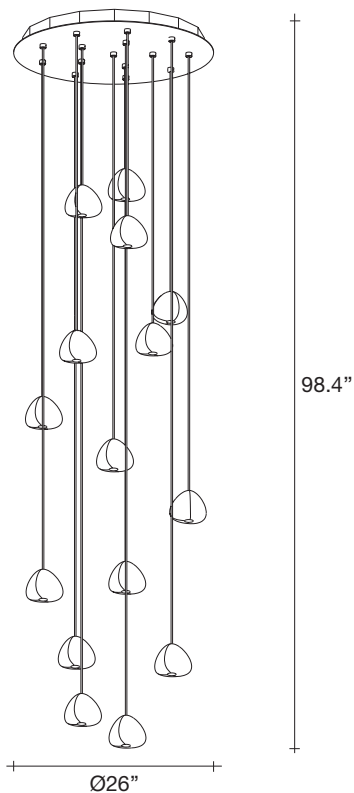

White canopy

Body |



**Recommended Light | Canopy |**

120V ~ 50/60Hz

-  XENON  
15 x 10W G4 12V
- or
-  LED  
15 x 2W G4 12V
-  Dimmable with IGBT and TRIAC
- or on request
-  LED integrated  
15 x 1,5W 2700 lm 3000K or optional 2700K
-  Dimmable with 1-10V and Dali system

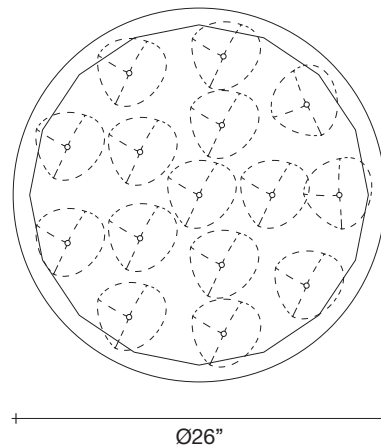

Inspired by the tranquil and mesmerizing light refractions created by water, Mizu is a customizable pendant light from Terzani. Like water droplets, no two Mizu are alike, each crystal shape is unique and made meticulously by hand. Using only the clearest crystal, Mizu perfectly emulates water's refraction of light, casting amazing patterns around the room, reminiscent of flowing water. Also available in gold leaf. Design Nicolas Terzani

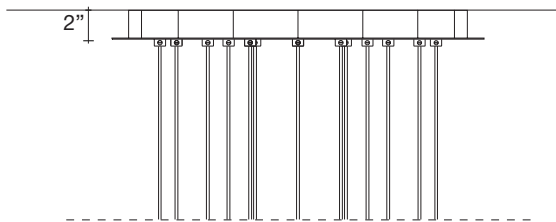

 88     79.2     30.3" x 30.3" x 11.8"

CASA DESIGN GROUP  
living outdoor contract

# Mizu, Flowing *Light*.



design Nicolas Terzani  
terzani.com



**Type |**  
Suspension

**Materials |**  
Clear crystal

**Finishes | Code**

-  Clear  
OR26S E8 A9 Q
-  Clear/Silver Dust  
OR26S E8 F4 Q
-  Clear/Gold  
OR26S E8 A4 Q



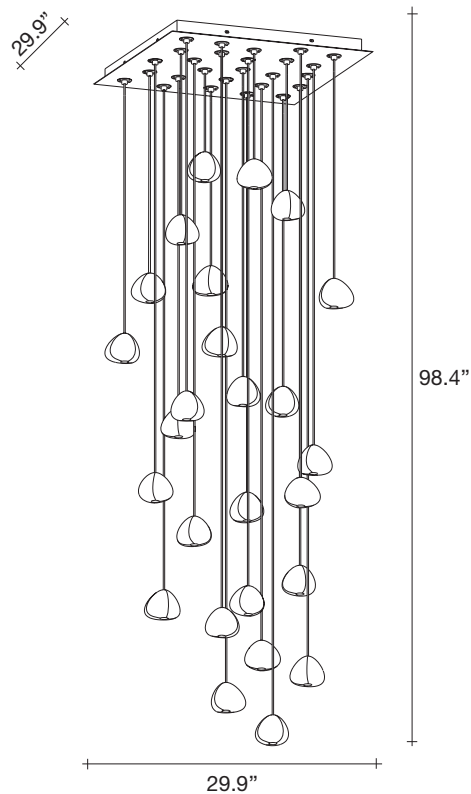

White canopy  
Quick system

Body |



**Recommended Light | Canopy |**

120V ~ 50/60Hz

-  XENON  
26 x 10W G4 12V
- or
-  LED  
26 x 2W G4 12V
-  Dimmable with IGBT  
and TRIAC
- or on request
-  LED integrated  
26 x 1,5W 4680 lm 3000K  
or optional 2700K
-  Dimmable with 1-10V  
and Dali system

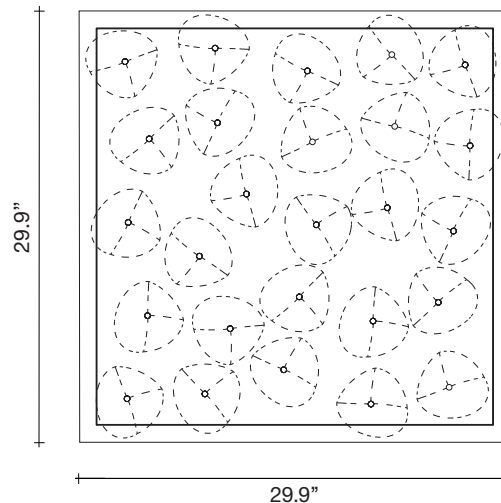

Inspired by the tranquil and mesmerizing light refractions created by water, Mizu is a customizable pendant light from Terzani. Like water droplets, no two Mizu are alike, each crystal shape is unique and made meticulously by hand. Using only the clearest crystal, Mizu perfectly emulates water's refraction of light, casting amazing patterns around the room, reminiscent of flowing water. Also available in gold leaf. Design Nicolas Terzani

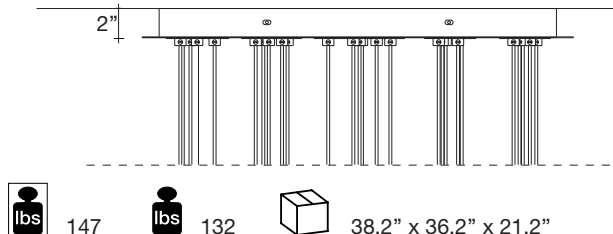



# Mizu, Flowing *Light*.



design Nicolas Terzani  
terzani.com



**Type |**  
Suspension

**Materials |**  
Clear crystal

**Finishes | Code**

-  Clear  
OR26S E8 A9 T
-  Clear/Silver Dust  
OR26S E8 F4 T
-  Clear/Gold  
OR26S E8 A4 T



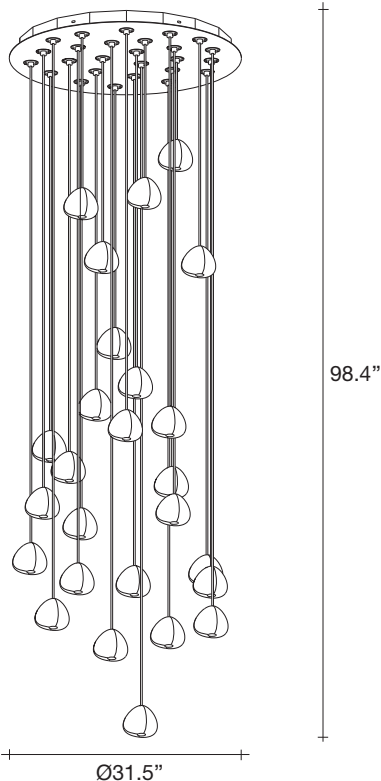

White canopy  
Quick system

**Body |**



**Recommended Light | Canopy |**

120V ~ 50/60Hz

-  XENON  
26 x 10W G4 12V
- or**
-  LED  
26 x 2W G4 12V
-  Dimmable with IGBT  
and TRIAC
- or on request**
-  LED integrated  
26 x 1,5W 4680 lm 3000K  
or optional 2700K
-  Dimmable with 1-10V  
and Dali system

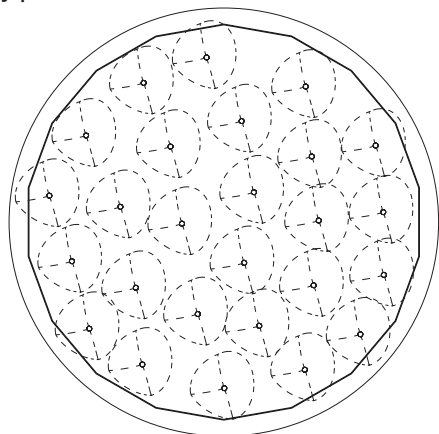

Inspired by the tranquil and mesmerizing light refractions created by water, Mizu is a customizable pendant light from Terzani. Like water droplets, no two Mizu are alike, each crystal shape is unique and made meticulously by hand. Using only the clearest crystal, Mizu perfectly emulates water's refraction of light, casting amazing patterns around the room, reminiscent of flowing water. Also available in gold leaf. Design Nicolas Terzani

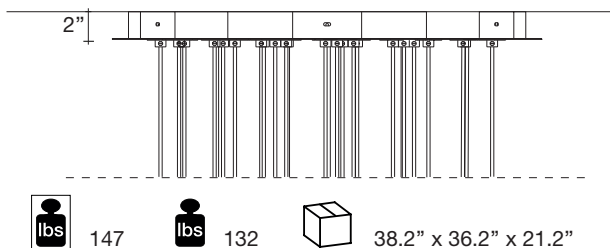

# Mizu, Flowing *Light*.

design Nicolas Terzani  
terzani.com



**Type |**  
Radial Canopy

**Materials |**  
Metal

**Finishes | Code**



White  
RADIALKITE8-12

Min **2** max **12** pendants

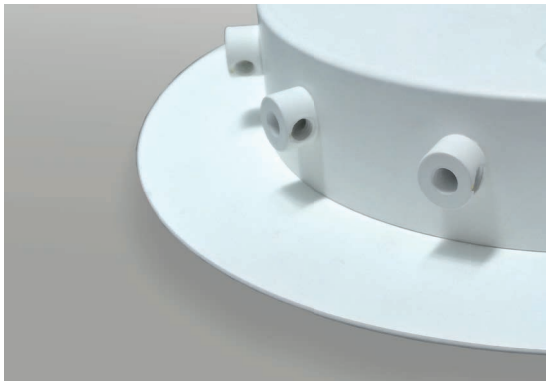

**120V ~ 50/60Hz**

 HALOGEN  
3 X 10-60W

 Dimmable with IGBT  
and TRIAC

**Canopy |**

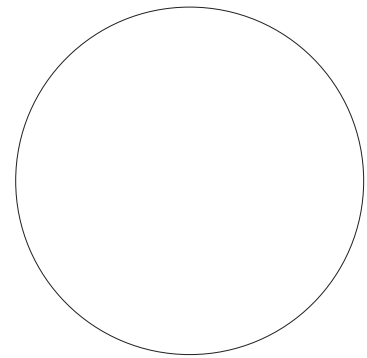

Ø11.4"

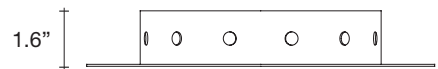

16.1" x 16.1" x 8.3"

# Mizu, Flowing *Light*.

design Nicolas Terzani  
terzani.com



**Type |**  
Radial Pendant  
**Materials |**  
Metal



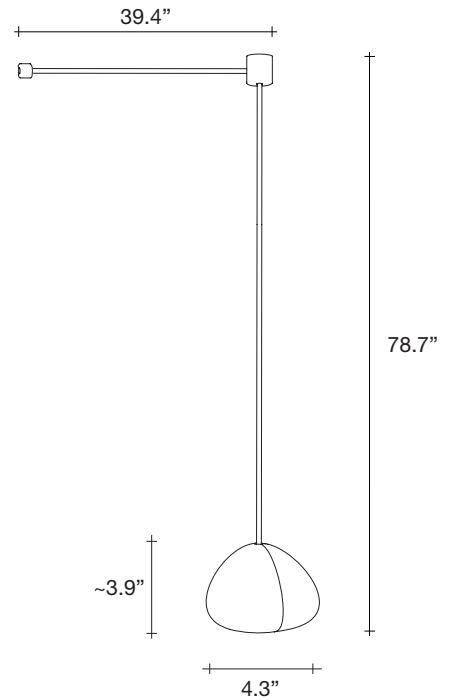

**Finishes | Code**

-  Clear  
OR01S E8 A9 X
-  Clear/Silver Dust  
OR01S E8 F4 X
-  Clear/Gold  
OR01S E8 A4 X

**Body |**



**120V ~ 50/60Hz**

-  HALOGEN  
10W G4 12V
- or**
-  LED  
2W G4 12V
-  Dimmable with IGBT  
and TRIAC
- or on request**
-  LED integrated  
1,5W 180 lm 3000K  
or optional 2700K
-  Not Dimmable

**Canopy |**



5.5



4.4



6.5" x 6.5" x 8.9"