

EXTRASOFT CONTENITORI

design Piero Lissoni

Family of modular storage units, available in two heights with open compartments of different sizes and capacities, to be combined with Extrasoft upholstered elements or usable as freestanding low tables. Made of MDF veneered in natural or charcoal-dyed oak, with 12mm thick tops and bases and 40mm thick side panels. All versions are with black adjustable PVC feet. The various elements are joined together by means of hooks.



Structure



Notes

The various elements are joined together by means of hooks to be placed in the appropriate milling, as per the instructions enclosed with the product.

Hooks for assembly with upholstered elements with standard feet in PVC.

Hooks for assembly with upholstered elements with feet with spacers.

In case of using spacers for upholstered elements, it is necessary to use the foot with height 7cm (2).

Extrasoft Contenitore unit foot standard height

Extrasoft Contenitore unit foot height 7cm.

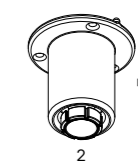
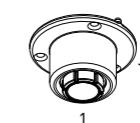
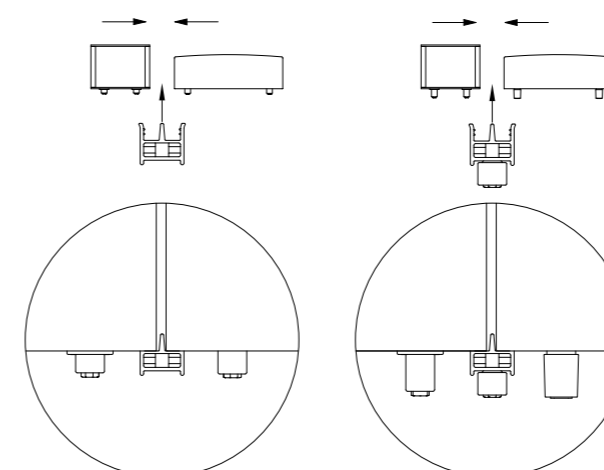

For composition with different elements, please attach a general sketch to the order.

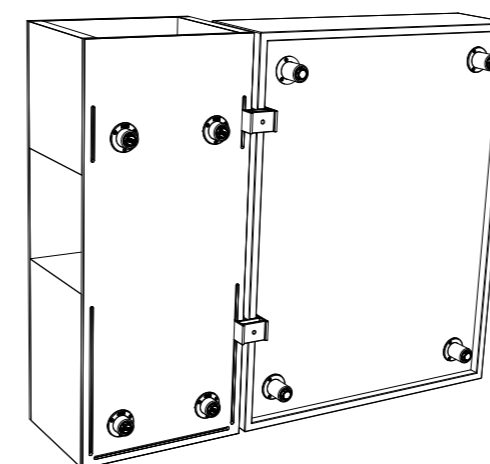

Technical Drawings

Storage unit cm.94x51 h.43-33

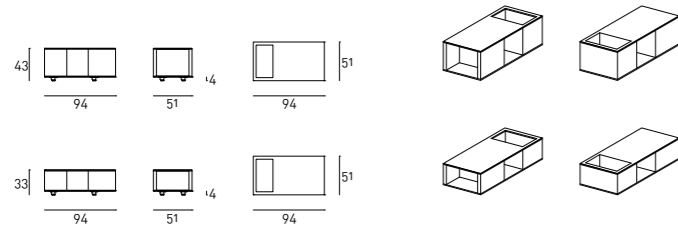

Storage unit cm.120x51 h.43-33

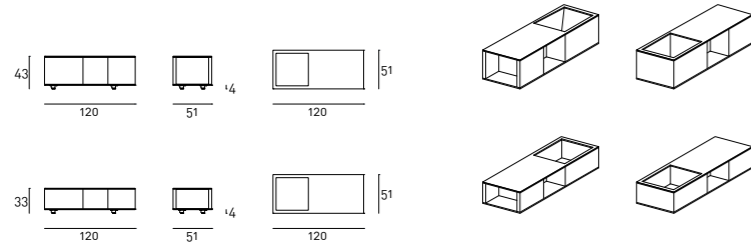

Storage unit cm.146x51 h.43-33

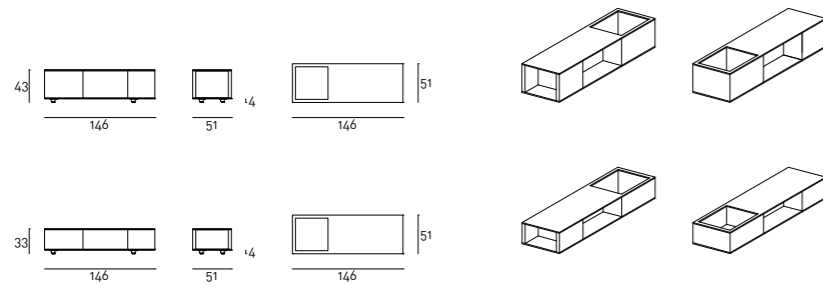

Examples of Composition

Composition 01

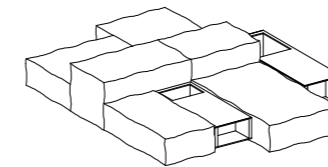
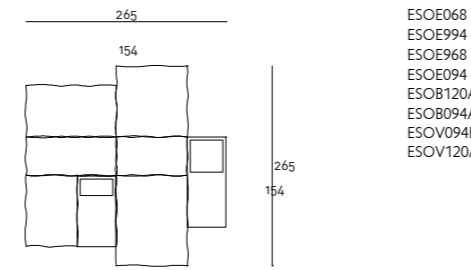

Composition 02

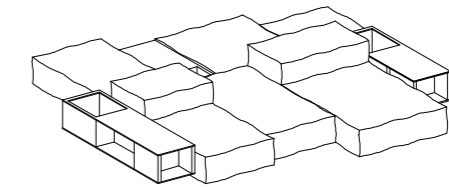
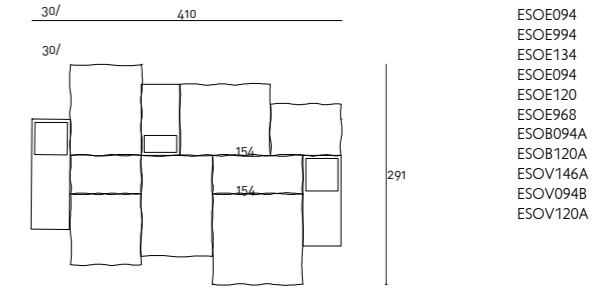

Composition 03

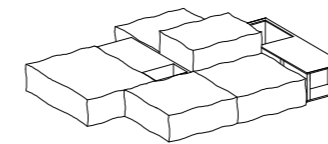
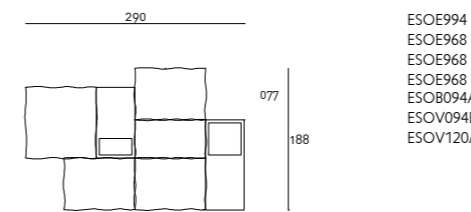

Composition 04

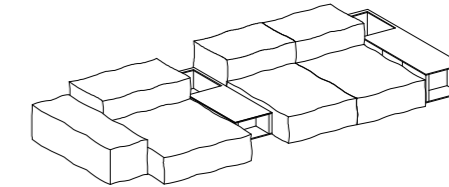
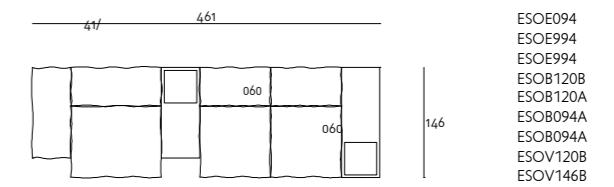

Composition 05

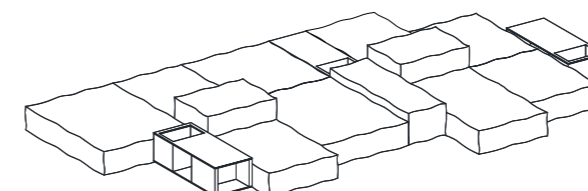
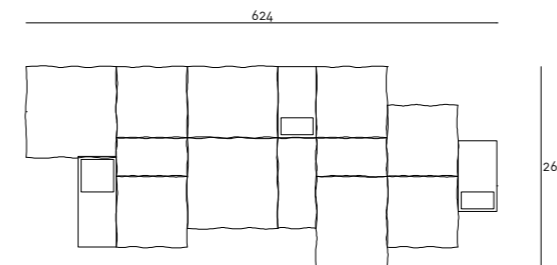

The commercial codes refer to the elements chosen in the above-proposed compositions.



