



Reinterpretation of the original project that proposes the top developed in square rather than in round shape. Top in solid Kauri and resin, stylized symbol of the Earth: the wood pieces represent the continents and the resin parts the oceans. Base in iron, with tubular section.

CODE	SIZE	BASE	A10
EARTH SQUARE 1	W.130 x D.130 x H.75	B2	■
		B3	■
EARTH SQUARE 2	W.140 x D.140 x H.75	B2	■
		B3	■
EARTH SQUARE 3	W.160 x D.160 x H.75	B2	■
		B3	■
EARTH SQUARE 4	W.180 x D.180 x H.75	B2	■
		B3	■
EARTH SQUARE 5	W.190 x D.190 x H.75	B2	■
		B3	■

AVAILABLE FINISHES:

A10: kauri

B2: lacquered iron: iron dust, RAL (only selected colours)

B3: lacquered iron matt brushed effect: aged bronze, stainless steel, titanium

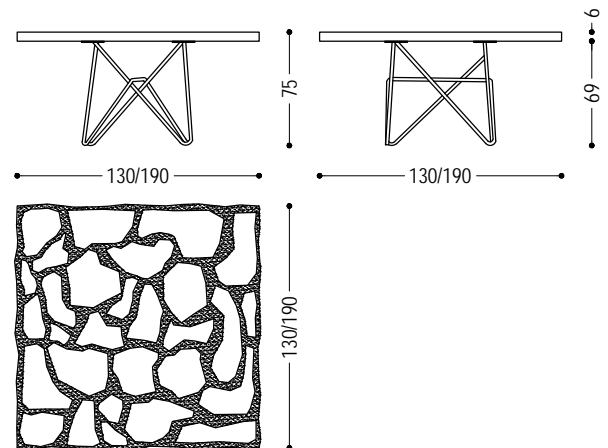

Kauri top drawing for illustrative purposes only

WOOD

A10



kauri

IRON

B2

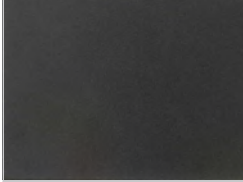

lacquered iron:
iron dust



ferro laccato:
RAL - 1013_OYSTER WHITE



ferro laccato:
RAL - 3020_TRAFFIC RED

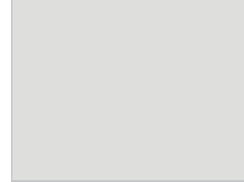

ferro laccato:
RAL - 7035_LIGHT GREY



ferro laccato:
RAL - 7037_DUSTY GREY



ferro laccato:
RAL - 8019_GREY BROWN

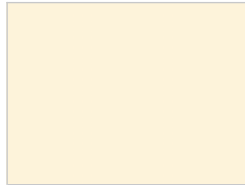

ferro laccato:
RAL - 9001_CREAM WHITE

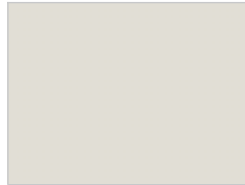

ferro laccato:
RAL - 9002_GREY WHITE



ferro laccato:
RAL - 9005_JET BLACK

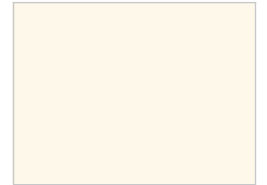

ferro laccato:
RAL - 9010_PURE WHITE

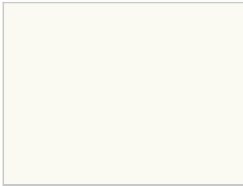

ferro laccato:
RAL - 9016_TRAFFIC WHITE

B3

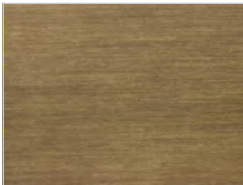

lacquered iron, matt brushed effect:
aged bronze

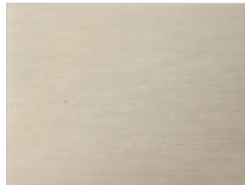

lacquered iron, matt brushed effect:
stainless steel

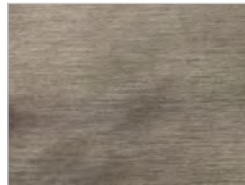

lacquered iron, matt brushed effect:
titanium