



Table with round top made of solid Kauri wood combined with a base composed of iron slats that taper to the center.

CODE	SIZE	BASE	A10
KAURI ROUND	KAURI SLAB TO BE SELECTED	B2	■
		B3	■

AVAILABLE FINISHES:

A10: kauri

B2: lacquered iron: iron dust, RAL (only selected colours)

B3: lacquered iron matt brushed effect: aged bronze, stainless steel, titanium

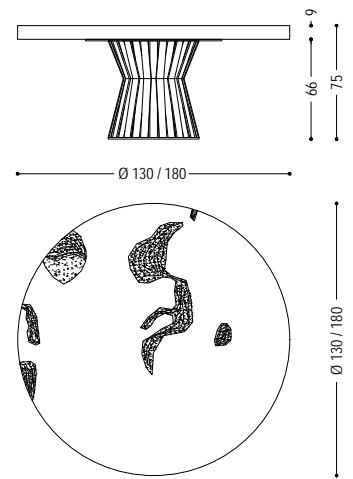

Kauri top drawing for illustrative purposes only

WOOD

A10



kauri

IRON

B2

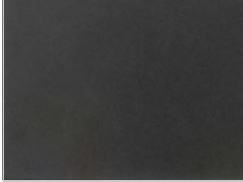

lacquered iron:
iron dust



ferro laccato:
RAL - 1013_OYSTER WHITE



ferro laccato:
RAL - 3020_TRAFFIC RED

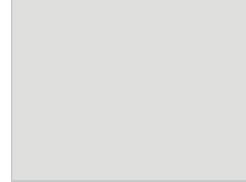

ferro laccato:
RAL - 7035_LIGHT GREY



ferro laccato:
RAL - 7037_DUSTY GREY



ferro laccato:
RAL - 8019_GREY BROWN

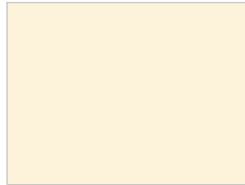

ferro laccato:
RAL - 9001_CREAM WHITE

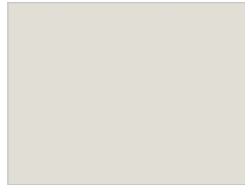

ferro laccato:
RAL - 9002_GREY WHITE



ferro laccato:
RAL - 9005_JET BLACK

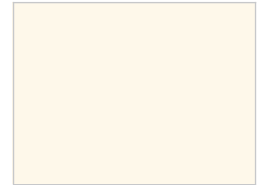

ferro laccato:
RAL - 9010_PURE WHITE

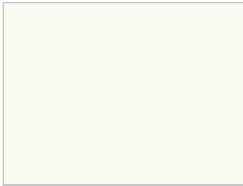

ferro laccato:
RAL - 9016_TRAFFIC WHITE

B3

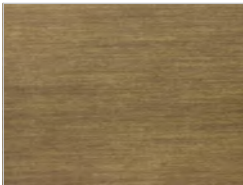

lacquered iron, matt brushed effect:
aged bronze

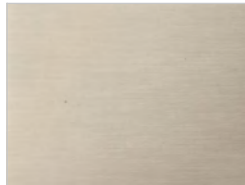

lacquered iron, matt brushed effect:
stainless steel

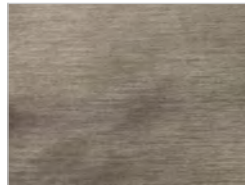

lacquered iron, matt brushed effect:
titanium