

IDRA

FICHA TÉCNICA



IDRA
PerezOchando

Colección de mesas de centro, auxiliares y de noche compuesta por tapa circular en MDF lacado, en chapa de roble, con cristal negro, cerámica statuario o compacto pizarra. Con estructura metálica termolacada negro o blanco microtexturado.

Collection of coffee, occasional and bedside tables comprising a lacquered MDF, oak veneer, with black glass, statuario ceramic or slate compact top. The metal structure is micro-textured black or white thermo-lacquered.

Mesas auxiliares / Mesitas de noche
Occasional tables / Bedside tables

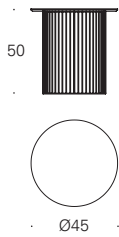

IDRA-45R Ø45x50 cm 0,151 m³ 9 Kg

Tapa laca / Estructura termolacada negro o blanco microtexturado
Lacquer top / Micro-textured black or white thermo-lacquered structure

Tapa roble / Estructura termolacada negro o blanco microtexturado
Oak top / Micro-textured black or white thermo-lacquered structure

Tapa compacto pizarra / Estructura termolacada negro microtexturado
Slate compact top / Micro-textured black thermo-lacquered structure

Tapa cristal negro / Estructura termolacada negro microtexturado
Black glass top / Micro-textured black thermo-lacquered structure

Tapa cerámica statuario / Estructura termolacada negro o blanco microtexturado
Statuario ceramic top / Micro-textured black or white thermo-lacquered structure

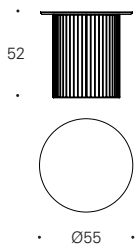

IDRA-55R Ø55x52 cm 0,202 m³ 12 Kg

Tapa laca / Estructura termolacada negro o blanco microtexturado
Lacquer top / Micro-textured black or white thermo-lacquered structure

Tapa roble / Estructura termolacada negro o blanco microtexturado
Oak top / Micro-textured black or white thermo-lacquered structure

Tapa compacto pizarra / Estructura termolacada negro microtexturado
Slate compact top / Micro-textured black thermo-lacquered structure

Tapa cristal negro / Estructura termolacada negro microtexturado
Black glass top / Micro-textured black thermo-lacquered structure

Tapa cerámica statuario / Estructura termolacada negro o blanco microtexturado
Statuario ceramic top / Micro-textured black or white thermo-lacquered structure

Mesas de centro
Coffee tables

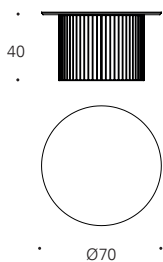

IDRA-74R Ø70x40 cm 0,273 m³ 13 Kg

Tapa laca / Estructura termolacada negro o blanco microtexturado
Lacquer top / Micro-textured black or white thermo-lacquered structure

Tapa roble / Estructura termolacada negro o blanco microtexturado
Oak top / Micro-textured black or white thermo-lacquered structure

Tapa compacto pizarra / Estructura termolacada negro microtexturado
Slate compact top / Micro-textured black thermo-lacquered structure

Tapa cristal negro / Estructura termolacada negro microtexturado
Black glass top / Micro-textured black thermo-lacquered structure

Tapa cerámica statuario / Estructura termolacada negro o blanco microtexturado
Statuario ceramic top / Micro-textured black or white thermo-lacquered structure

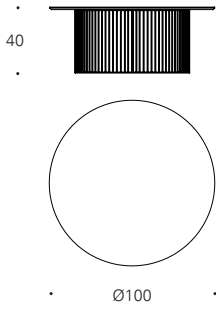

IDRA-04R

Ø100x40 cm

0,527 m³ 29 Kg

Tapa laca / Estructura termolacada negro o blanco microtexturado
Lacquer top / Micro-textured black or white thermo-lacquered structure

Tapa roble / Estructura termolacada negro o blanco microtexturado
Oak top / Micro-textured black or white thermo-lacquered structure

Tapa compacto pizarra / Estructura termolacada negro microtexturado
Slate compact top / Micro-textured black thermo-lacquered structure

Tapa cristal negro / Estructura termolacada negro microtexturado
Black glass top / Micro-textured black thermo-lacquered structure

Tapa cerámica statuario / Estructura termolacada negro o blanco microtexturado
Statuario ceramic top / Micro-textured black or white thermo-lacquered structure

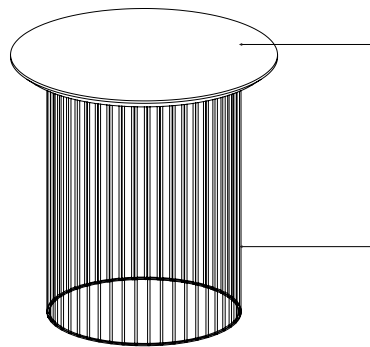

Tapa - Laca, roble, compacto pizarra,
cristal negro, cerámica statuario
Top - Lacquer, oak, slate compact,
black glass, statuario ceramic

Estructura - Metal termolacado
negro o blanco microtexturado
Structure - Black or white thermo-lacquered
micro-textured metal

ACABADOS FINISHES

MADERA | WOOD



Roble natural
Natural oak



Roble claro
Light oak



Roble teñido wengue
Wengue stained oak



Roble teñido ceniza
Ash stained oak



Roble teñido tostado
Toasted stained oak

CRISTAL | GLASS

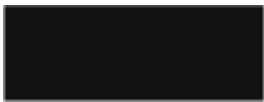

Cristal negro
Black glass



Compacto pizarra
Slate compact



Cerámica statuario
Statuario ceramic

COMPACTO | COMPACT

CERÁMICA STATUARIO | STATUARIO CERAMIC

LACA MATE | MATT LACQUER



Piedra
Stone
—
RAL 7044



Arena
Sand
—
NCS S2005-Y20R



Visión
Taupe
—
NCS S4005-Y20R



Grafito
Graphite
—
RAL 7022



Niebla
Fog
—
NCS S5005-B20G



Océano
Ocean
—
NCS S7010 B10G



Pizarra
Slate
—
NCS S8500-N



Negro
Black
—

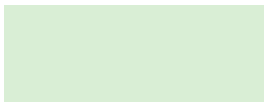

Menta
Mint
—
NCS S3010 G20Y



Oliva
Olive
—
NCS S6010 G10Y



Bosque
Forest
—
NCS S7010-B90G

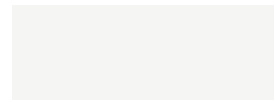

Blanco
White
—



Teja
Tile
—
NCS S5030 Y90R

Opcionalmente se pueden solicitar otros colores de laca referenciados según la carta RAL o carta NCS.

Alternatively you can request other colours of lacquer referenced according to RAL or NCS card.