

Products / Lounge Chairs / Hamptons Lounge Chair

# Hamptons lounge chair

by Ramón Esteve

Hamptons, the **new collection of designer outdoor furniture** consists of a set of pieces where a careful selection of fabrics and patterns evoke that “lifestyle” where elegance is perceived in the finest details.



# Info

## Description

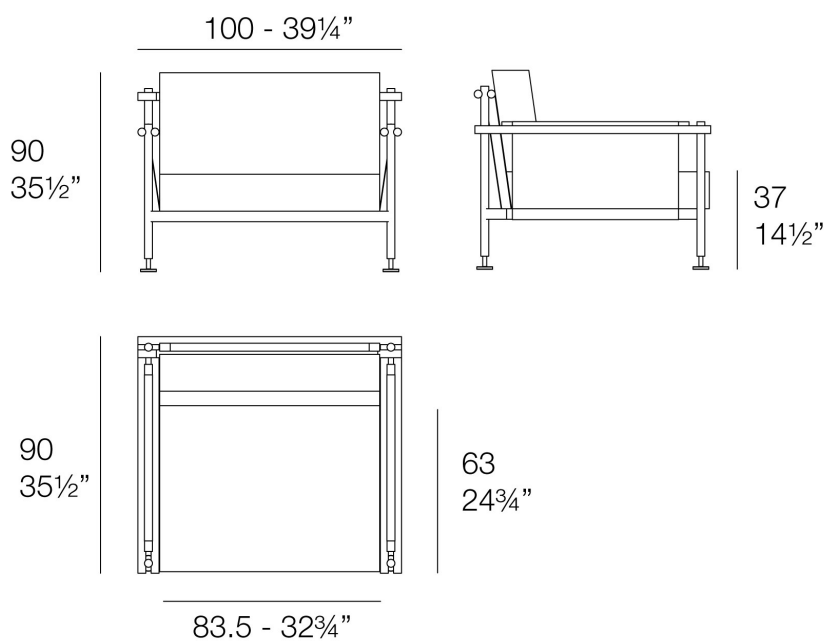

HAMPTONS Butaca  
HAMPTONS Lounge Chair

# Finishes

---

## aluminium

---

### ALUMINIUM

Ref. 54800



white



british gray



traffic gray



black



ecru



crema



castoro fiber



cacao



notte blue



modo green

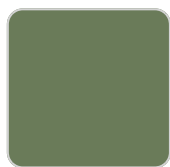

pickle

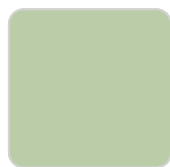

almond



red

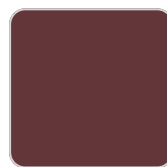

purjai red

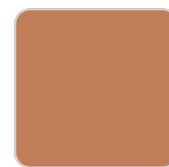

melon

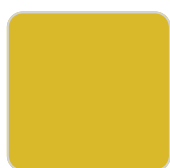

mostaza

Lacquered aluminium profile.

## fabric

---

### SILVERTEX

Ref. 54800CO



forest 1224



beige 1211



bronze 1214



khaki 1218



steel 1208



taupe 1209



antrachite 1210

Vinyl fabric suitable for indoor and outdoor use. Special option for upholstery.

## CREVIN

Ref. 54800CO



white 1308

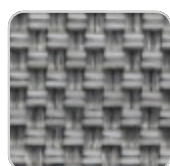

steel 1309



taupe 1310

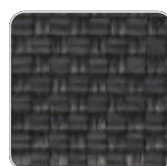

anthracite 1311

Upholstery fabric, that as and natural appearance and can be easy cleaned by washing machines, allowing an easy removal of mildew. Suitable for indoor and outdoor use

## CICO

Ref. 54800CO

Cozy fabric with an elegant look and soft touch.

## ACAPULCO

Ref. 54800CO

Cozy fabric with an elegant look and soft touch.

SIESTA  
Ref. 54800CO

Cozy fabric with an elegant look and soft touch.

IKON  
Ref. 54800CO

Cozy fabric with an elegant look and soft touch.

HERITAGE  
Ref. 54800CO



granite 1531

Outdoor fabrics are waterproof 50% recycled acrylic, 47% acrylic and 3% PE.

SAVANE  
Ref. 54800CO



white 1501

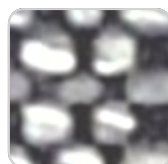

tornado 1503



whisper 1502

Outdoor fabrics are waterproof 100% acrylic.

# Ambients

---

