

JACKIE POLTRONA E BERGERE Design Gianfranco Frigerio

Struttura: legno multistrato e massello imbottiti in poliuretano espanso indeformabile rivestito in tessuto protettivo accoppiato.

Piedini: in legno massello finitura noce Canaletto o tinto Wenge

Rivestimento: sfoderabile in tessuto, fisso in pelle.

Profilo: stesso materiale e colore del rivestimento. Su richiesta in contrasto esclusivamente in Grosgrain.

Structure: plywood and solid wood padded with non-deformable polyurethane foam covered with doubled protective fabric.

Feet: in solid wood Canaletto walnut or Wenge colour

Cover: removable in fabric, fix in leather.

Piping: same material and colour as the cover. On request in contrast exclusively in Grosgrain.



JACKIE POLTRONA E BERGERE

Design Gianfranco Frigerio

POLTRONE / ARMCHAIRS

cod. 11504

Poltrona / Armchair

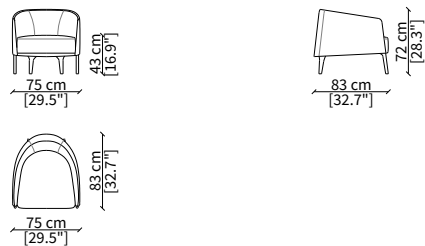

cod. 11508

Bergere

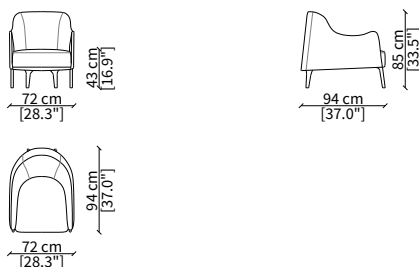

SEDIA / CHAIR

cod. 11512

Sedia / Chair

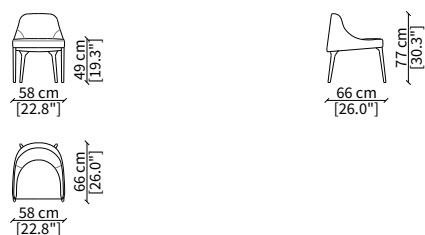

POLTRONCINA / SMALL ARMCHAIR

cod. 11503

Poltroncina / Small Armchair

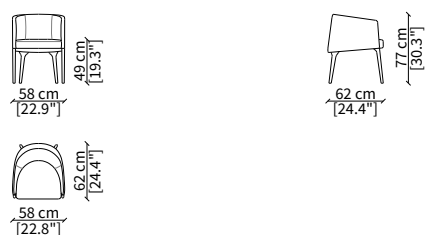

CHAISE LONGUE

cod. 11507

Chaise Longue

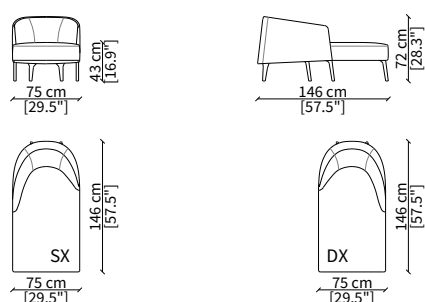

Dimensioni espresse in cm se non diversamente indicato.
L'Azienda si riserva il diritto di apportare modifiche ai modelli senza preavviso.
Tolleranza sulle misure indicate di +/- 2%.

Dimensions in centimeter if not differently indicated.
The Company reserves the right to change the models without any advance notice.
Tolerance on the given sizes +/- 2%.

DIVANETTI / SMALL SOFAS

cod. 11509

Divanetto / Small Sofa

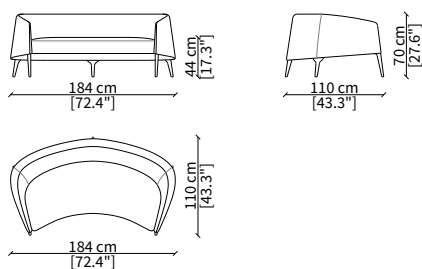

cod. 11510

Divanetto Bergere / Small Sofa Bergere

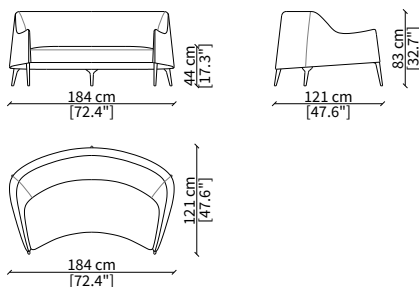

POUF

cod. 11511

Pouf

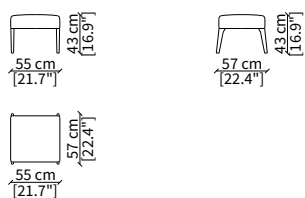

CUSCINI / CUSHIONS

cod. B01

Cuscino $\varnothing 47$ cm con profilo e bottone
Cushion $\varnothing 47$ cm with piping and button

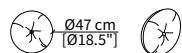

cod. B02

Cuscino 65x30 cm con profilo e bottone
Cushion 65x30 cm with piping and button



cod. JR

Cuscino $\varnothing 47$ cm con profilo
Cushion $\varnothing 47$ cm with piping

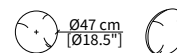

cod. JA

Cuscino 65x30 cm con profilo
Cushion 65x30 cm with piping



cod. JQ

Cuscino 47x47 cm con profilo
Cushion 47x47 cm with piping



JACKIE POLTRONA E BERGERE Design Gianfranco Frigerio

TESSUTO / FABRIC



Asolo



Avignone



Bellagio



Butterfly



Caprera



Capri



Caracalla



Chioggia

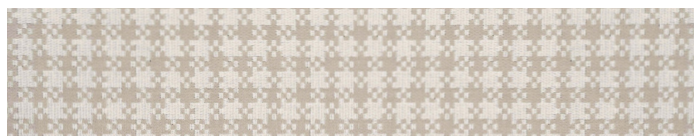

Candotti



Dorian

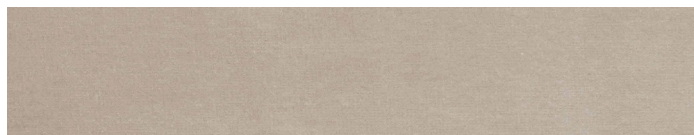

Fiocco



Il Trovatore



Ischia



Katmandu



La Boheme



Lario

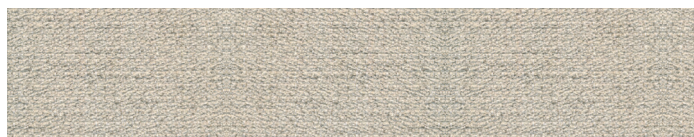

Linosa



Maddalena

La presente tabella tessile, pelli e materiali è a solo titolo indicativo e non vincolante. L'effettiva disponibilità di ogni materiale deve essere preventivamente verificata con l'ufficio commerciale Frigerio.

L'azienda si riserva il diritto di sospendere la disponibilità di qualsiasi materiale senza alcun obbligo di preavviso sulla presente scheda tecnica.

I colori visualizzati, per ovvie ragioni tecniche, sono indicativi e possono differire dall'originale. Fare riferimento al listino prezzi per uso e disponibilità di ogni singola finitura.

The above textile, leather and material charts are only indicative and not binding. The actual availability of any material shall be checked in advance with the Frigerio commercial office. The company reserves the right to discontinue any material without any obligation of due notice on this technical data sheet.

The colours visualized, for obvious technical reasons, are indicative and may differ from the original.

Please refer to price list for use and availability of each finish.

JACKIE POLTRONA E BERGERE Design Gianfranco Frigerio

TESSUTO / FABRIC



Moritz

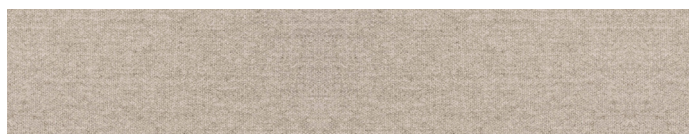

Nebraska

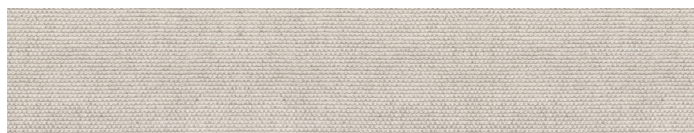

Padova

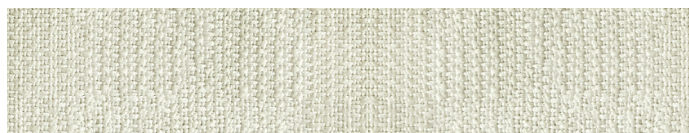

Panarea



Piazza Di Spagna

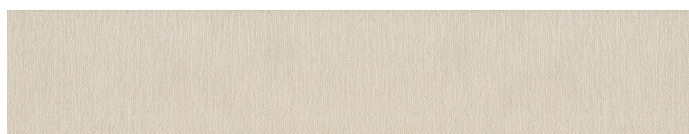

Ponza



Porto Cervo



Porto Rotondo

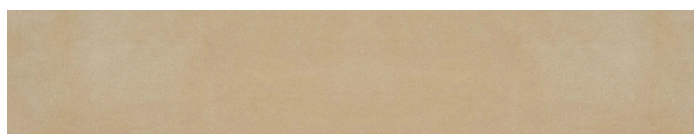

Rem



San Remo

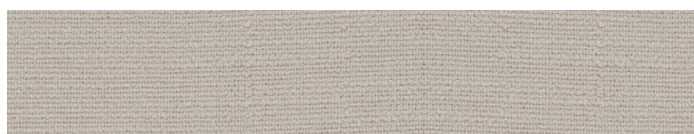

Tellaro



Tenerife

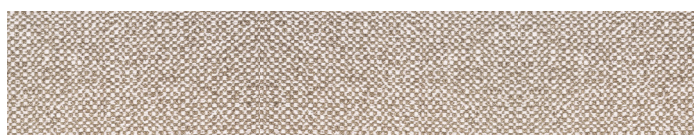

Turandot



Ventotene



Villa Borghese

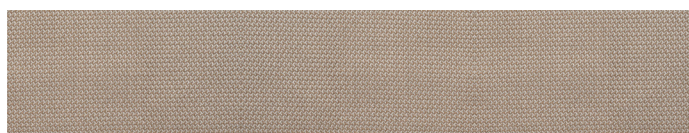

Villa d'Este

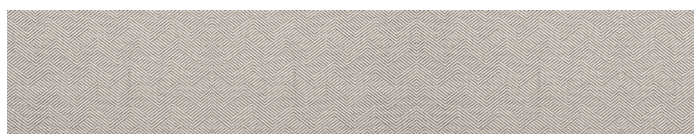

Villa Flori



VF 1650

La presente tabella tessile, pelli e materiali è a solo titolo indicativo e non vincolante. L'effettiva disponibilità di ogni materiale deve essere preventivamente verificata con l'ufficio commerciale Frigerio.

L'azienda si riserva il diritto di sospendere la disponibilità di qualsiasi materiale senza alcun obbligo di preavviso sulla presente scheda tecnica.

I colori visualizzati, per ovvie ragioni tecniche, sono indicativi e possono differire dall'originale. Fare riferimento al listino prezzi per uso e disponibilità di ogni singola finitura.

The above textile, leather and material charts are only indicative and not binding. The actual availability of any material shall be checked in advance with the Frigerio commercial office. The company reserves the right to discontinue any material without any obligation of due notice on this technical data sheet.

The colours visualized, for obvious technical reasons, are indicative and may differ from the original.

Please refer to price list for use and availability of each finish.

JACKIE POLTRONCINA
Design Gianfranco Frigerio

TESSUTO / FABRIC

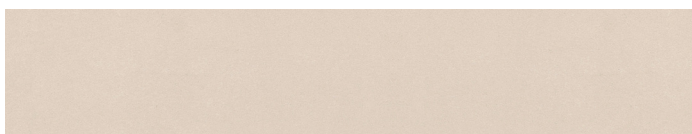

VF 1700



VF 1750



VF 1800

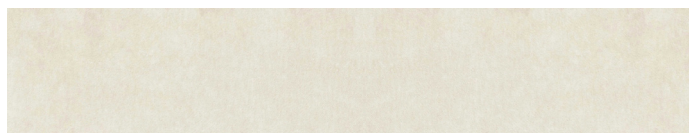

VF 2450



VF 2550

PELLE / LEATHER

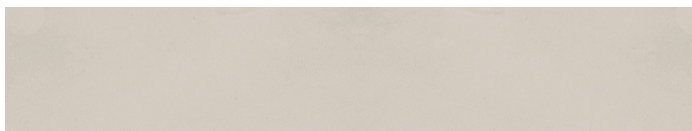

Nubuk

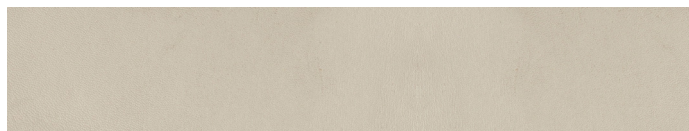

Anilina

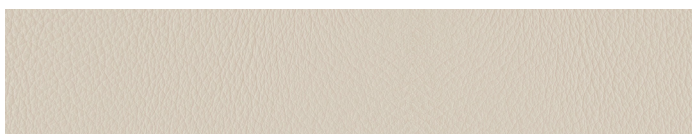

Siena



Bolgheri

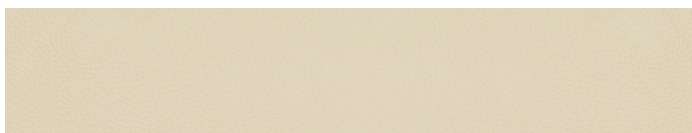

Pisa

ESSENZE / WOOD



Noce Canaletto
Walnut Canaletto

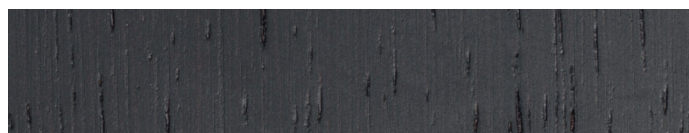

Frassino Wengè
Ashwood Wengè

PROFILO / PIPING

Per il profilo tono su tono fare riferimento alla gamma tessile Frigerio.
Per il profilo in contrasto, disponibile solo in Grosgrain, fare riferimento
al listino prezzi e alla pagina del sito dedicata.

For piping tone on tone please refer to the textile range of Frigerio.
For piping in contrast, available only in Grosgrain, please refer to the
price list and the dedicated landing page in our website.

La presente tabella tessile, pelli e materiali è a solo titolo indicativo e non vincolante. L'effettiva disponibilità di ogni materiale deve essere preventivamente verificata con l'ufficio commerciale Frigerio.

*L'azienda si riserva il diritto di sospendere la disponibilità di qualsiasi materiale senza alcun obbligo di preavviso sulla presente scheda tecnica.
I colori visualizzati, per ovvie ragioni tecniche, sono indicativi e possono differire dall'originale.
Fare riferimento al listino prezzi per uso e disponibilità di ogni singola finitura.*

*The above textile, leather and material charts are only indicative and not binding. The actual availability of any material shall be checked in advance with the Frigerio commercial office.
The company reserves the right to discontinue any material without any obligation of due notice on this technical data sheet.*

*The colours visualized, for obvious technical reasons, are indicative and may differ from the original.
Please refer to price list for use and availability of each finish.*