

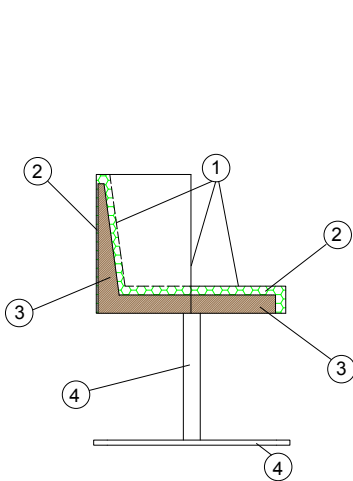

Tigram: the art of playing with geometrical shapes (and turning them into sofas and chairs)

Starting out from Tangram, the ancient Chinese game based on arranging seven geometrical shapes in combinations to form an endless variety of designs and figures, Adrenalina has developed a collection of padded elements that re-invents the original brain teaser. The seven basic elements are armchairs, sofas, poufs and stools, all rigorously modeled on a hexagonal base and featuring different sizes, heights, and colours, which can be combined and separated to create figures and symbols in a kaleidoscope of variations. The simple shapes of Tigram's primary elements allow a tremendous and exciting variety of combinations that give birth to complex clusters of figures that can be freely interpreted both by those who arrange them and by the observer.

The choice of single elements can be summed up in a harmonic yet explosive whole, but you can also let them drift away from each other and let them recover their individual charm. Tigram can be an articulated combination of elements, but each element can also elegantly stand on its own to stylize a corner or to fashion a cozy and friendly parlour.



TIGRAM CHAIR:

- 1 - dacron® fiber 100 gr;
- 2 - high resilience polyurethane foam of different densities;
- 3 - structural frame in plywood;
- 4 - swivel base in shiny inox and column in chrome metal.

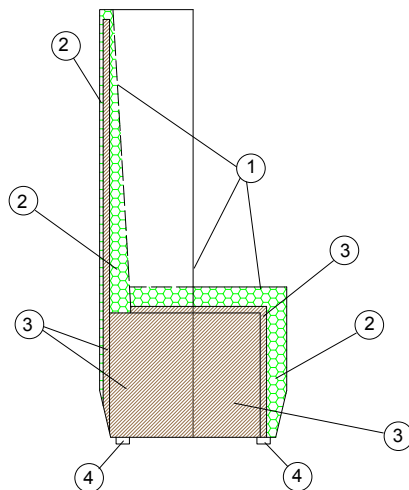

TIGRAM LOW-HIGH:

- 1 - dacron® fiber 100 gr;
- 2 - high resilience polyurethane foam of different densities;
- 3 - structural frame in plywood;
- 4 - PVC feet.

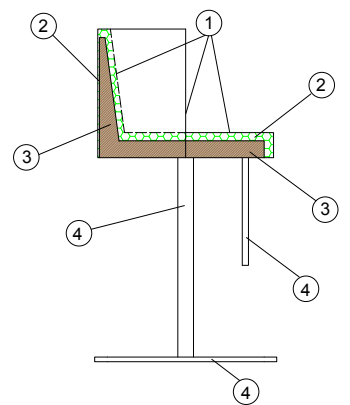

TIGRAM STOOL:

- 1 - dacron® fiber 100 gr;
- 2 - high resilience polyurethane foam of different densities;
- 3 - structural frame in plywood;
- 4 - swivel base in shiny inox and column in chrome metal.



DESIGN ITALO PERTICHINI

TIGRAM

DIMENSIONS:

Low

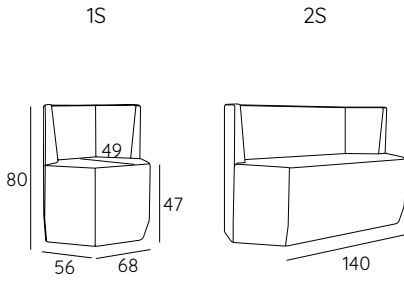

High

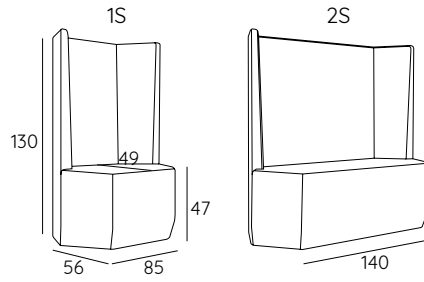

Chair

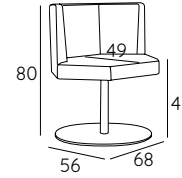

Stool

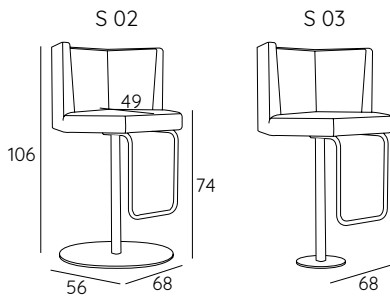

Pouf

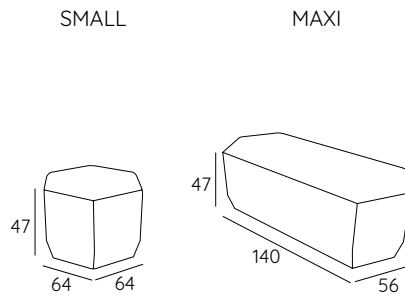

FEET AND BASES:

Low e High



Chair



Stool

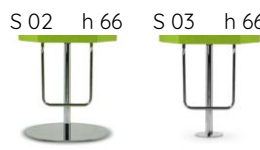

Pouf



METAL BASES FINISHINGS:

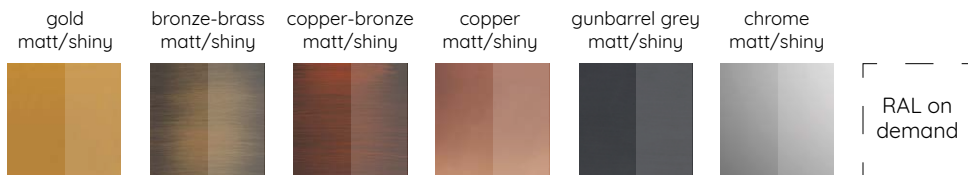

TECHNICAL DETAILS:

Removable cover: NO	kg	m ³	mts		kg	m ³	mts
TIGRAM LOW 1S	20	0.30	2.80	TIGRAM STOOL S 02	32	0.40	2.80
TIGRAM LOW 2S	39	0.63	4.00	TIGRAM STOOL S 03	25	0.40	2.80
TIGRAM HIGH 1S	34	0.62	3.80	TIGRAM POUF SMALL	13	0.19	1.20
TIGRAM HIGH 2S	48	1.02	5.00	TIGRAM POUF MAXI	30	0.37	2.80
TIGRAM CHAIR	24	0.30	2.80				

SUGGESTED CONFIGURATIONS:

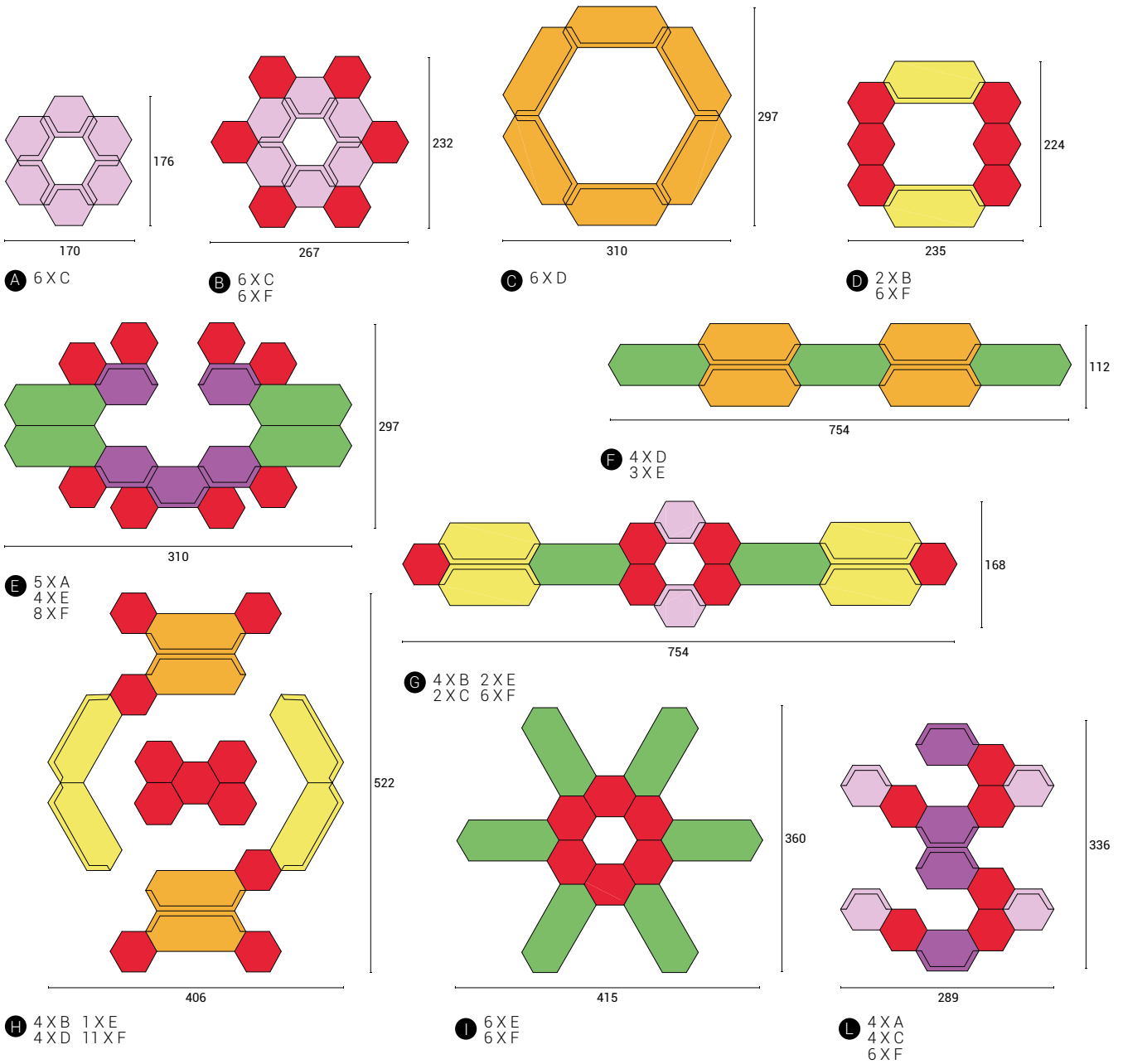
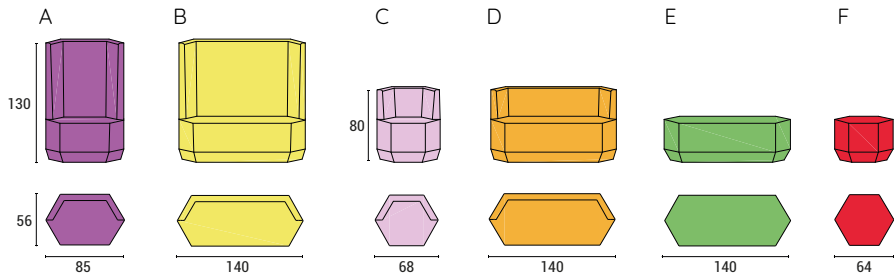

11M

DESIGN ITALO PERTICHINI

TIGRAM

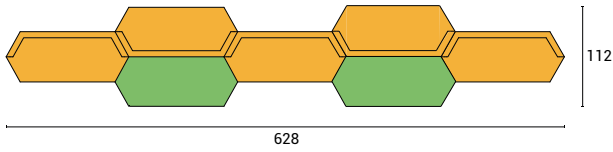

M 5XD
2XE

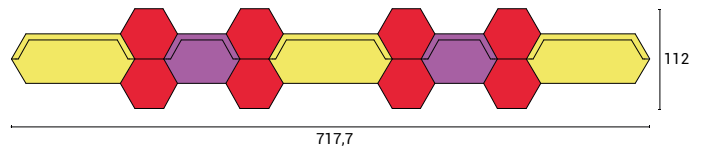

N 2XA
3XB
8XF

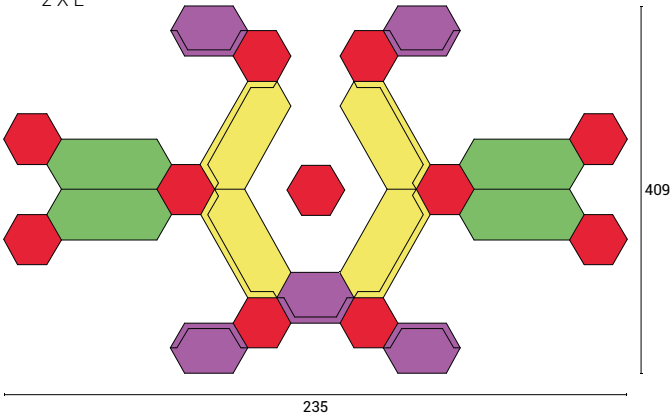

O 5XA 4XE
4XB 11XF

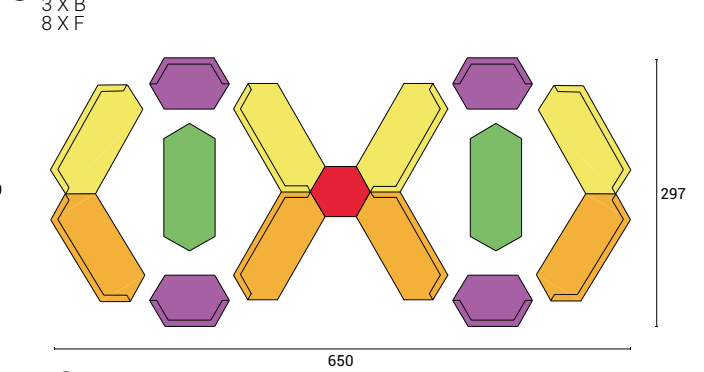

P 4XA 2XE
4XB 1XF
4XD

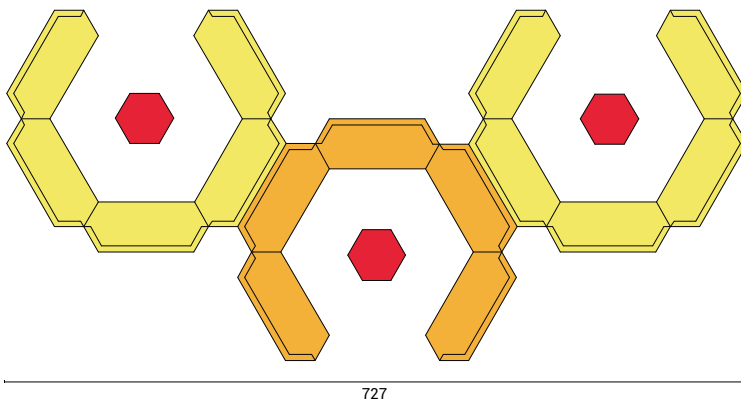

Q 10XB
5XD
3XF

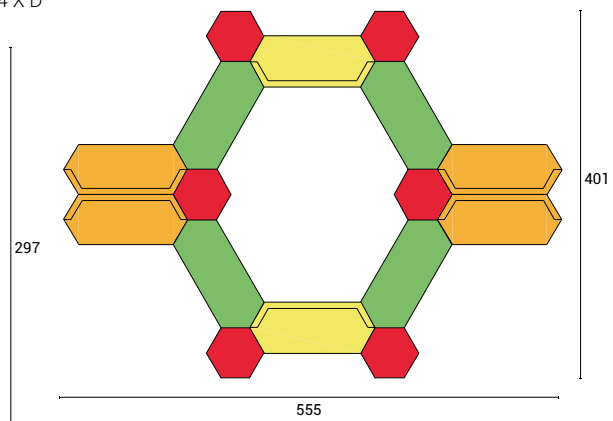

R 12XB
6XD
3XF

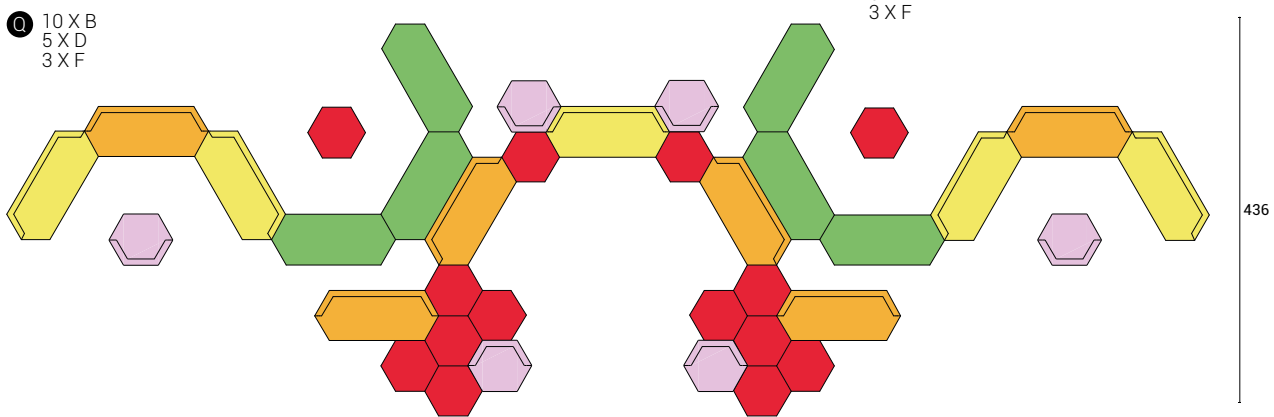

S 5XB 6XE
6XC 14XF
6XD

SUGGESTED FABRICS:



PHOTO GALLERY:



Tigram low armchair



Tigram low sofa



Tigram high armchair



Tigram high sofa



Tigram chair



Tigram pouf small e maxi