

# SIR-PENT

DESIGN ANDREA STRAMIGIOLI

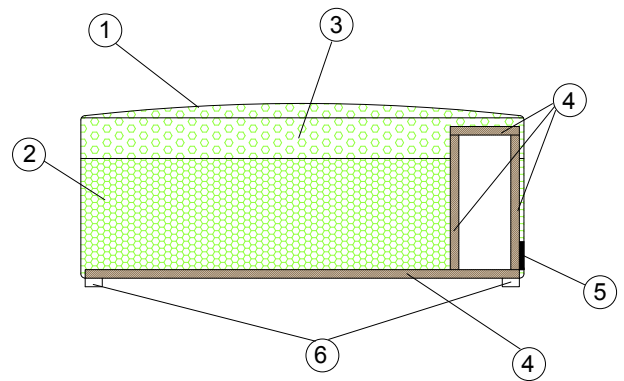

Sir-Pent is a curious being that lives on Planet Earth with the intention of creating islands of relaxation with linear or compound shapes, winding lightly and discreetly in places where its fluidity and its quiet presence unfussingly claim their own essentiality. In the free and sinuous unfolding of its soft and discrete shapes, Sir-Pent surprises and charms with the technological accessories that emerge from the softness of the seating surfaces: USB or Schuko charging outlets, hidden wireless charging devices, magazine racks or tablet holders and a technological plant connected to ItAir, a patented air purification system. Sir-Pent fits into the rotational motions of our planet as a safe landing point, attracting hurried passers-by with a gravitational action similar to that the Sun and the Moon exert on Planet Earth.



- 1 - dacron® fiber 100 gr;
- 2 - high resilience polyurethane foam of different densities;
- 3 - high resilience polyurethane memory foam;
- 4 - structural frame in plywood;
- 5 - high attraction magnets;
- 6 - wooden feet.

## DIMENSIONS:

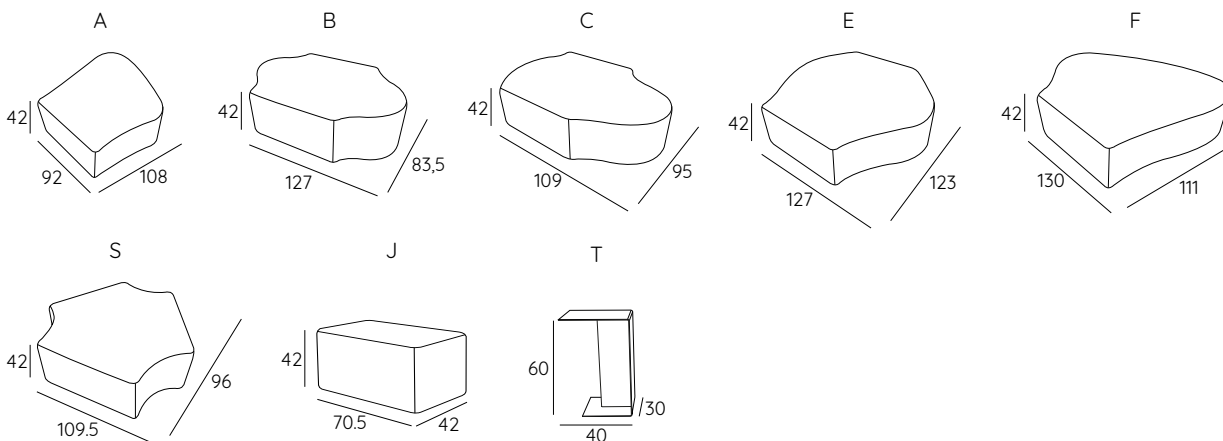

# SIR-PENT

DESIGN ANDREA STRAMIGIOLI

## FEET:

h 2



## J ELEMENT:



**J SMART**

Equipped with smart vase, usb, wireless, schuko sockets.



**J RACK**

Equipped with magazines rack, usb, wireless, schuko sockets.



**J VIDEO**

Equipped with tablet/ screen holder, usb, wireless, Schuko sockets.

## T ELEMENT:



**TABLE T**

Painted sheet metal side table with fabric insert.

## DEVICES:

### USB



Two USB socket.  
Power supply 230 V.  
Different voltage upon request.

### WIRELESS



Wireless smartphone charger.  
Power supply 230 V.  
Different voltage upon request.

### SCHUKO



Schuko socket.  
Power supply 230 V.  
UK and USA plug on demand.

## CLEANING FRIENDLY CONNECTORS:

### HIDDEN MAGNETIC CONNECTORS

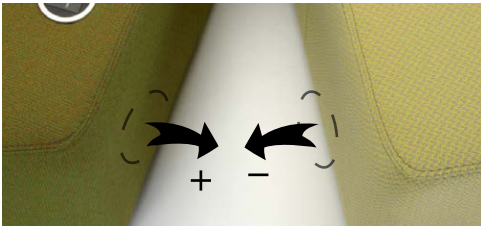

Cleaning friendly magnetic connectors with hidden magnets inside of the elements, particularly suitable to facilitate the movement of the elements during the cleaning of the environment.

On demand: traditional steel connectors

### TRADITIONAL CONNECTOR

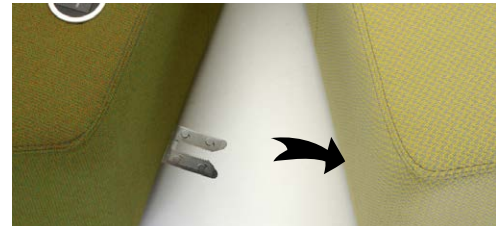

## SMART VASE:

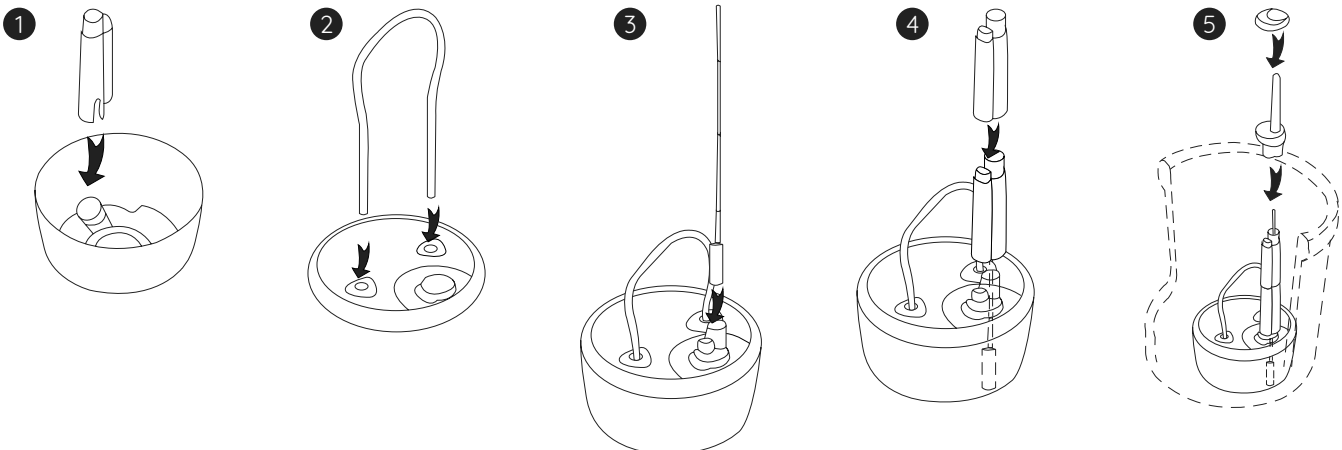

# SIR-PENT

DESIGN ANDREA STRAMIGIOLI

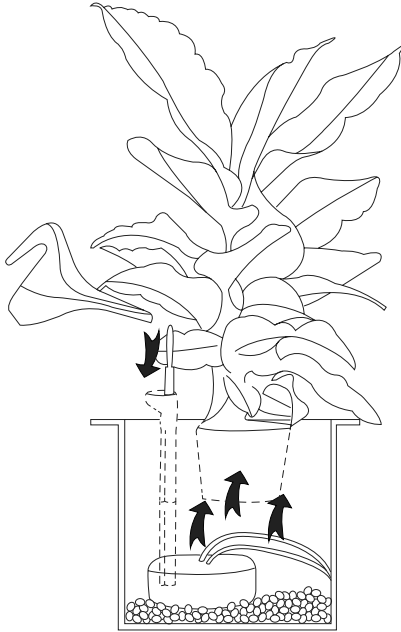

Itair® is an innovative natural air purifier for indoors. In this system, the plant stops being just ornamental and becomes the key figure as its purifying properties get amplified thanks to a technological core. The plant becomes a real filter, thanks to microorganisms in its roots, it can actively metabolize toxic agents that are present in the air, for example the VOC (Volatile Organic Compounds). Thanks to a forced mechanical ventilation, the system increases the air flux in the roots of the plant and it increases its effectiveness exponentially. Itair® connects to Wi-Fi and it can be managed with a proprietary app that works with smartphones and tablets. Thanks to the app, consumers will have a real-time experience:

- Real-time analysis of the pollutants in indoors spaces
- Temperature and Humidity monitor
- Analytics

Itair® has been tested thanks to specific laboratory exams which have proved its effectiveness.

Scientific validation has been given by the combined work of LINV, International Laboratory for Plant Neurobiology ([www.linv.org](http://www.linv.org)) and PNAT, spin-off of the University of Florence ([www.pnat.net](http://www.pnat.net)), these are probably two of the most notable laboratories on plants in the world, which have also collaborated.

## SUGGESTED PLANTS

- Sansevieria Trifasciata - Variagated Snake Plant
- Spathiphyllum "Mauna Loa" - Peace Lily
- Anthurium Andraeanum - Flamingo Lily
- Aglaonema Modestum - Chinese Evergreen
- Nephrolepis exaltata - Boston Fern
- Nephrolepis oblitterata - Kimberley Queen Fern
- Aloe Vera
- Ficus benjamina - Weeping Fig
- Dracaena Marginata - Red-Edged Dracaena
- Epipremnum aureum - Devil's Ivy - Liriope spicata - Lilyturf

- Liriope spicata - Lilyturf
- Hedera helix - English Ivy
- Dracaena fragrans "Massangeana" - Cornstalk Dracaena
- Gerbera Jamesonii - Barberton Daisy
- Rhaps excelsa - Broadleaf Lady Palm
- Chlorophytum comosum - Spider Plant
- Phoenix robelenii - Dwarf Date Palm
- Chamaedorea seifrizii - Bamboo Palm
- Philodendrum Cordatum - Heartleaf Philodendron
- Dieffenbachia - Dumb Cane
- Ficus elastica - Rubber Plant

## ITAIR APP:

1. Download the SMART AIR PURIFIER app for free from Google play or Apple store;
2. Once you have connected the plant to the power supply, connect it to the WiFi of the Smartphone or tablet you want to use. Search ITAIR AP from the Available Networks list, enter Password "0987654321" and confirm;
3. Once the connection has been established, open the SMART AIR PURIFIER app, click on the blue Itair bar and the plant will be connected;
4. At the bottom of the screen you will find the ON-OFF slider to turn the device on and off, while on the upper part you will find the data relating to the values perceived by the air quality, temperature and humidity sensors;
5. Swiping the screen from left to right, you will open



a menu on the left and find the following items:

- HOME
  - TIMERS to schedule the automatic activation and shutdown of the plant at set times.
  - WIFI where you can rename your plant, and you can connect it to your home or business WiFi network.
  - DEVICES where you will find the list of devices connected to the application in case there are several ITAIR units connected;
  - BIBLIOGRAPHY where you can find the list of suitable plants for ITAIR and select your own;
6. From the WIFI function, connect the plant to your home or business WiFi network.

## TECNICAL DETAILS:

Removable cover: NO	kg	m <sup>3</sup>	mts
SIR-PENT A ELEMENT	23	0.42	3.50
SIR-PENT B ELEMENT	26	0.44	4.00
SIR-PENT C ELEMENT	33	0.43	5.50
SIR-PENT E ELEMENT	40	0.66	6.00
SIR-PENT F ELEMENT	31	0.61	5.50
SIR-PENT S ELEMENT	23	0.44	5.00
SIR-PENT J ELEMENT	17	0.12	2.30
SIR-PENT T ELEMENT	17	0.07	1.50

# SIR-PENT

DESIGN ANDREA STRAMIGIOLI

## SUGGESTED CONFIGURATIONS:

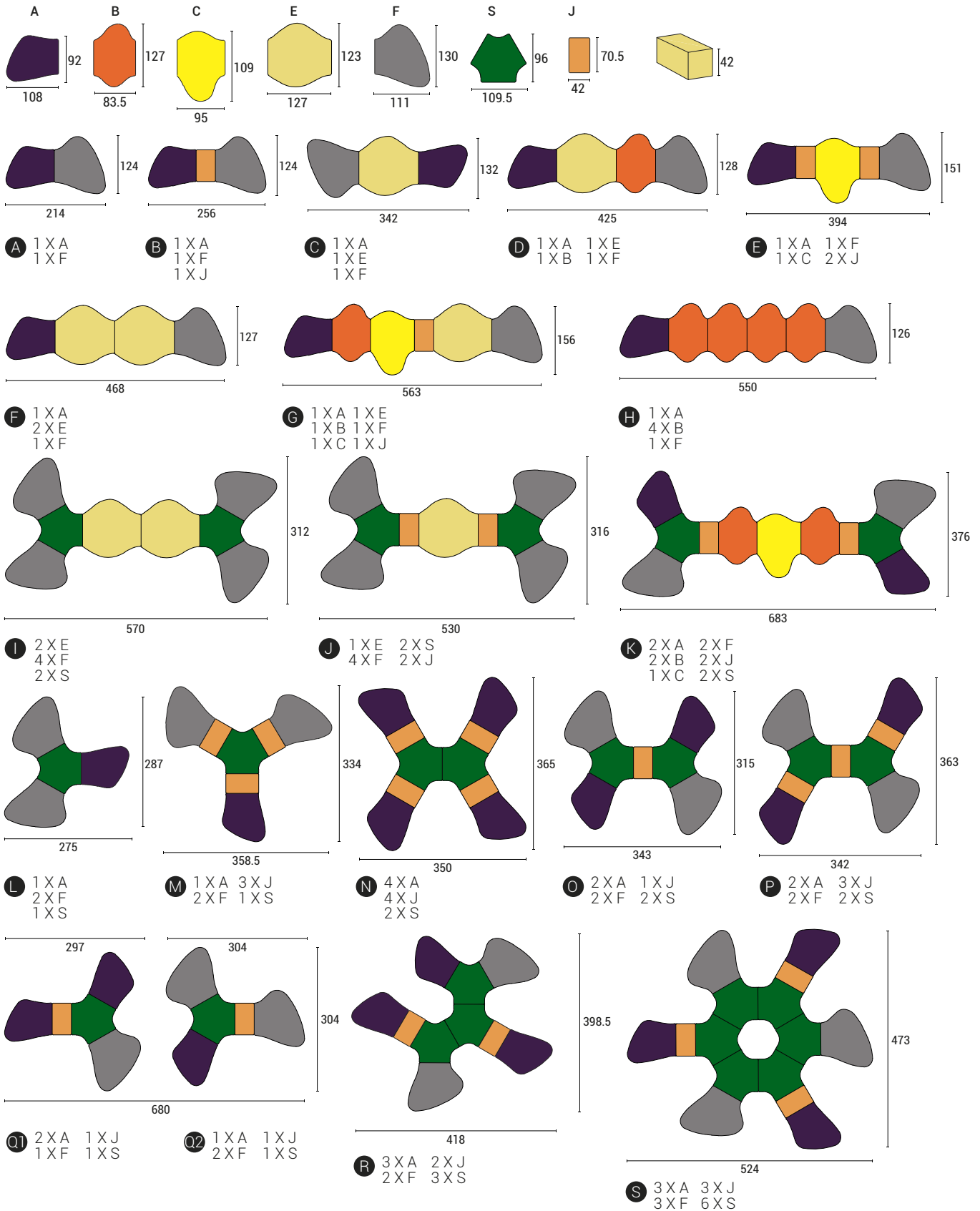

# SIR-PENT

DESIGN ANDREA STRAMIGIOLI

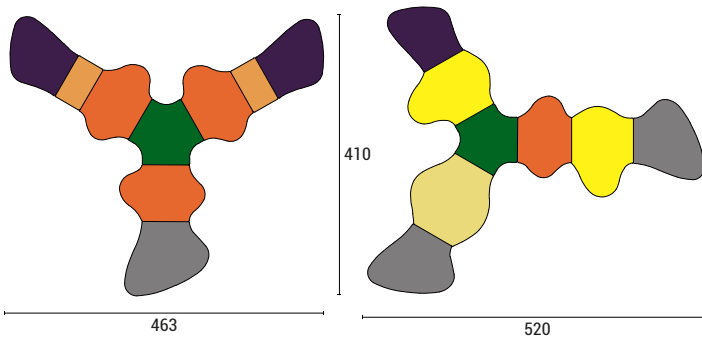

**T** 2XA 2XJ  
3XB 1XS  
1XF

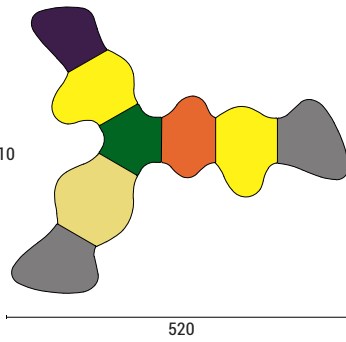

**U** 1XA 1XE  
1XB 2XF  
2XC 1XS

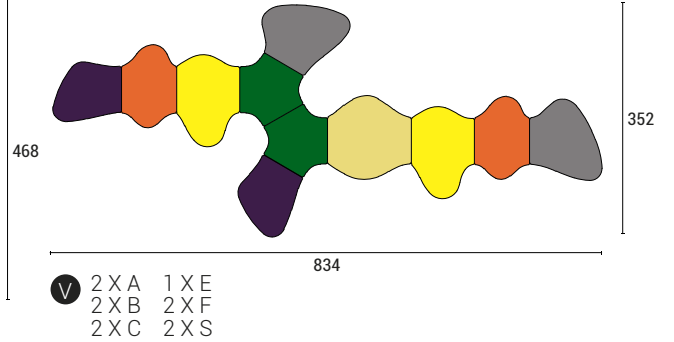

**V** 2XA 1XE  
2XB 2XF  
2XC 2XS

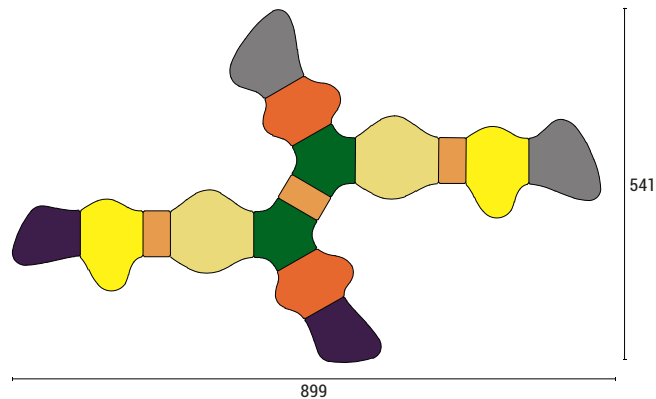

**W** 2XA 2XF  
2XB 3XJ  
2XC 2XS  
2XE

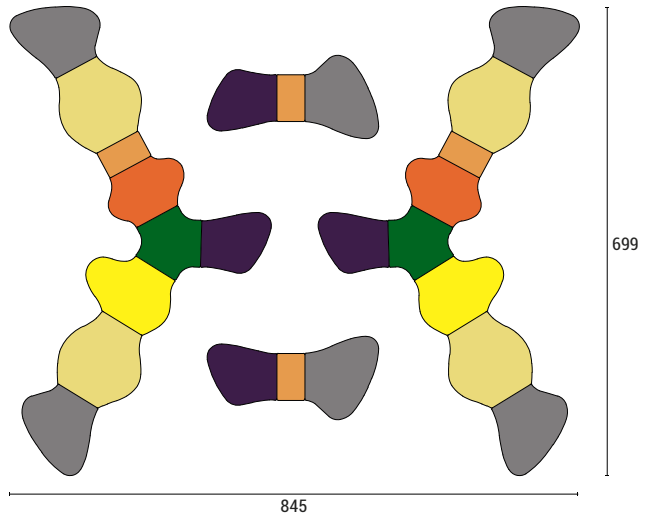

**X** 4XA 6XF  
2XB 4XJ  
2XC 2XS  
4XE

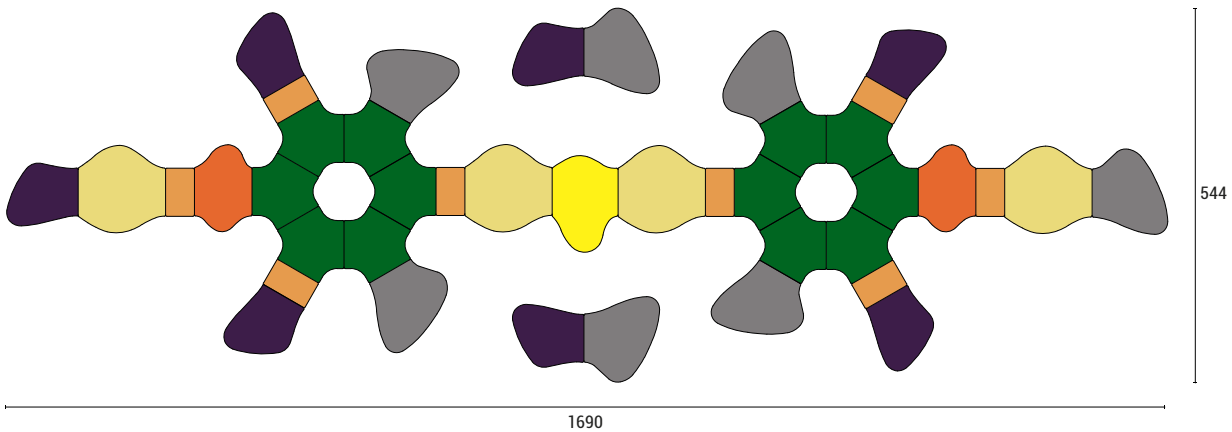

**Y** 7XA 6XF  
2XB 8XJ  
1XC 12XS  
4XE



# SIR-PENT

DESIGN ANDREA STRAMIGIOLI

## SUGGESTED FABRICS:



## PHOTO GALLERY:

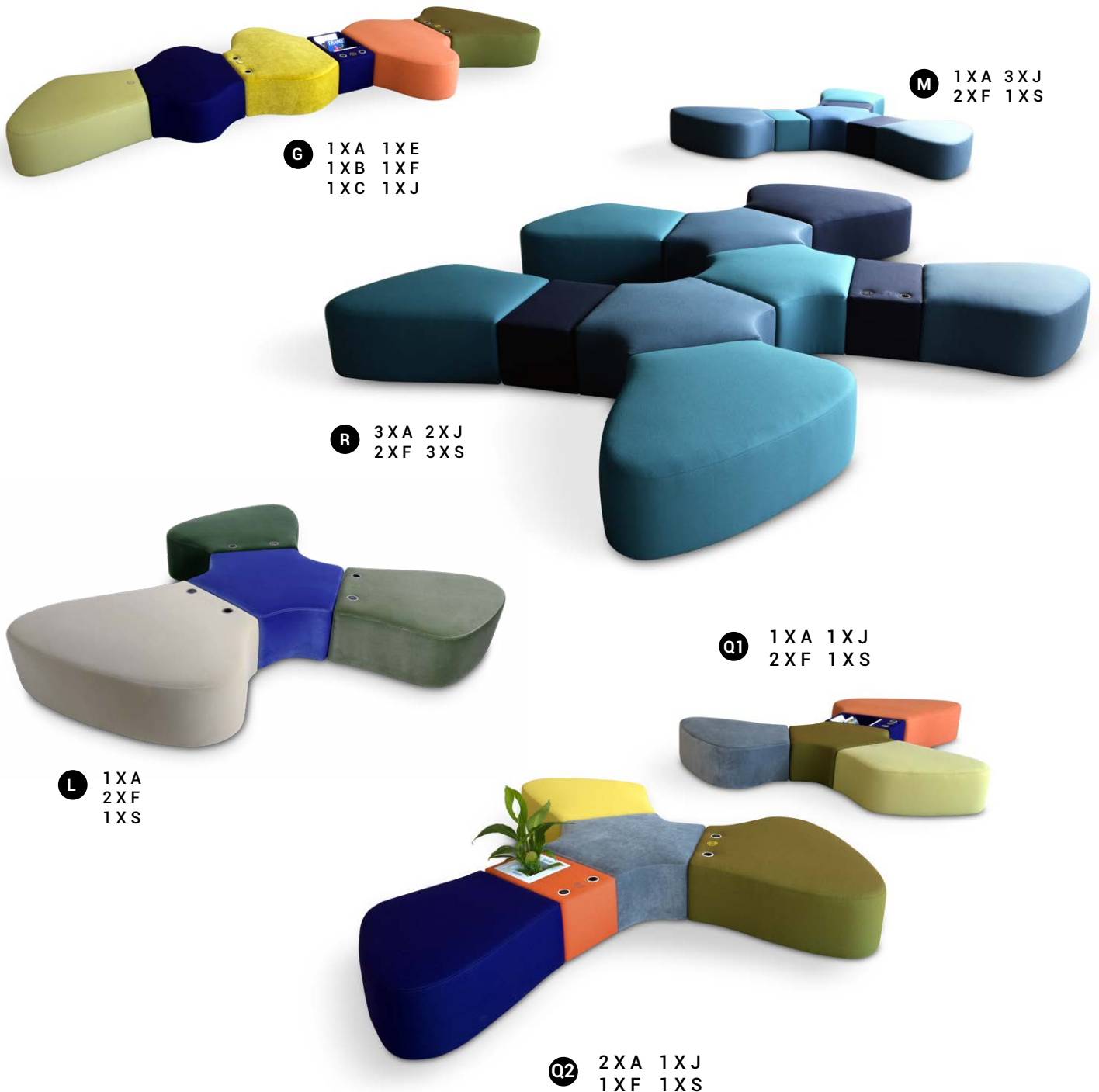

DESIGN ANDREA STRAMIGIOLI

# SIR-PENT



**P** 2 X A 3 X J  
2 X F 2 X S



**K** 2 X A 2 X S  
2 X B 2 X F  
1 X C 2 X J