

MICROMEGA

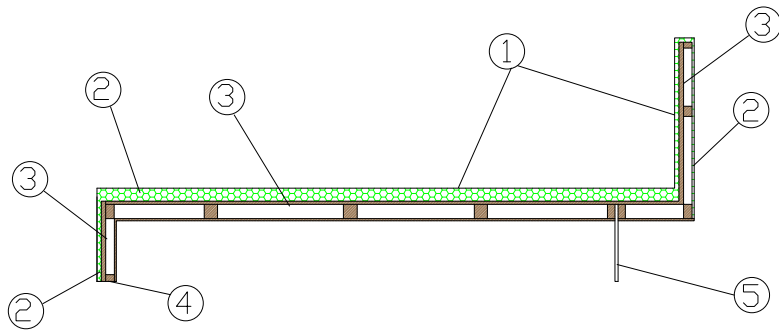

Micromega focuses on man and his needs to meet and socialize in defined, comfortable and aesthetically pleasing spaces; hence the reason why we symbolically borrowed the circular and square shapes of Leonardo's Vitruvian scheme. Micromega is a micro-architecture intended for mega public spaces, such as hotel lobbies, and allows you to create endless and stunning combinations. Micromega is a modular upholstered seating system for commercial environments, but with small modules that can be used even in contemporary domestic space.



MICROMEGA SEATINGS:

- 1 - dacron® fiber 100 gr;
- 2 - high resilience polyurethane foam of different densities;
- 3 - structural frame in plywood;
- 4 - PVC feet;
- 5 - shiny steel/plexiglass in plywood coated foot.

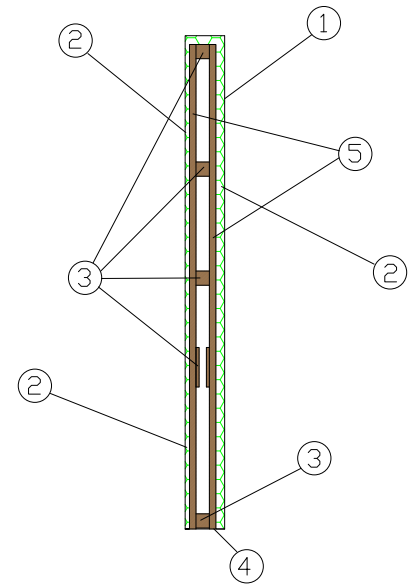

MICROMEGA PANELS:

- 1 - dacron® fiber 100 gr;
- 2 - high resilience polyurethane foam of different densities;
- 3 - structural frame in plywood;
- 4 - PVC feet;
- 5 - structural frame in MDF.



DESIGN **ROBERTO ROMANELLO**

MICROMEGA

DIMENSIONS:

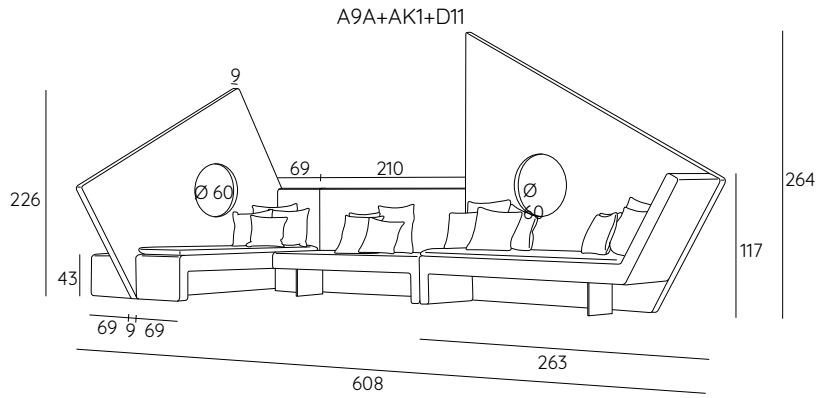
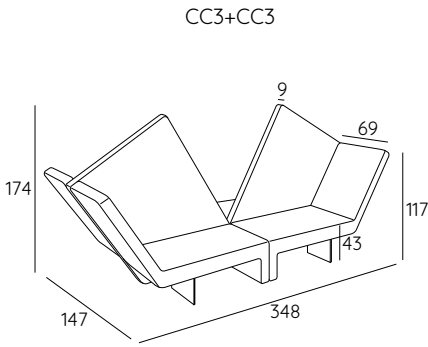

MOVABLE SEAT CUSCHION



CUSCHIONS

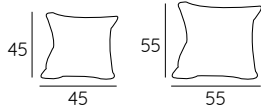

FEET:

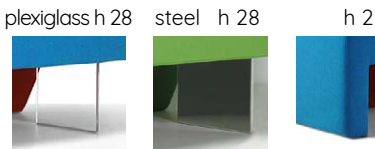

TECHNICAL DETAILS:

Removable cover: AVAILABLE UPON REQUESTED	kg	m ³	mts		kg	m ³	mts
MICROMEGA SEAT A	/	1.54	4.20	MICROMEGA BACKREST 6	/	0.33	7.65
MICROMEGA SEAT AK	/	0.59	3.20	MICROMEGA BACKREST 7	/	0.51	11.65
MICROMEGA SEAT B	/	2.15	5.20	MICROMEGA BACKREST 8	/	0.49	11.00
MICROMEGA SEAT BK	/	0.81	4.70	MICROMEGA BACKREST 9	/	0.53	12.00
MICROMEGA SEAT C	/	1.40	4.20	MICROMEGA BACKREST 10	/	0.63	13.20
MICROMEGA SEAT D	/	2.12	5.20	MICROMEGA BACKREST 11	/	0.62	12.65
MICROMEGA BACKREST 1	/	0.20	4.70	MOVABLE SEAT CUSCHION	0.50	/	1.60x1 mtl
MICROMEGA BACKREST 2	/	0.28	6.20	CUSCHION 45X45	0.50	0.02	0.50
MICROMEGA BACKREST 3	/	0.26	7.70	CUSCHION 55X55	0.50	0.03	0.60
MICROMEGA BACKREST 4	/	0.29	7.80	COMPOSITION CC3+CC3	/	8.90	(1) 16.80 (2) 15.40
MICROMEGA BACKREST 5	/	0.38	9.60	COMPOSITION A9A+AK1+D11	/	42.20	(1) 17.80 (2) 29.35

CC3+CC3

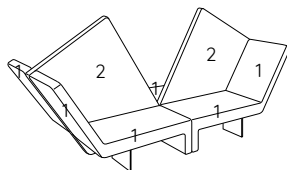

A9A+AK1+D11

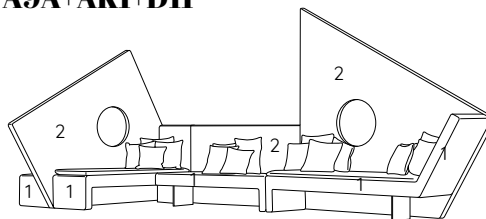

11M

DESIGN **ROBERTO ROMANELLO**

MICROMEGA

DESIGN SOLUTIONS OFFICE:

1

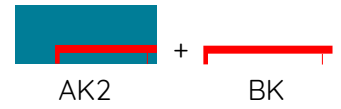
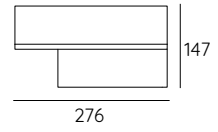
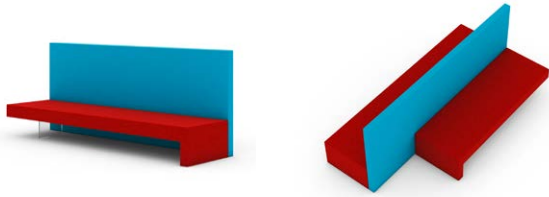

2

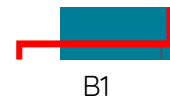
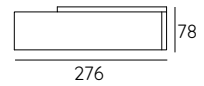
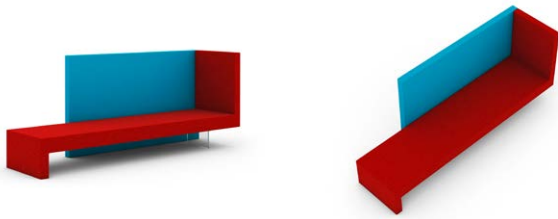

3

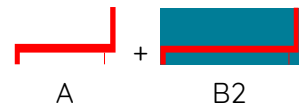
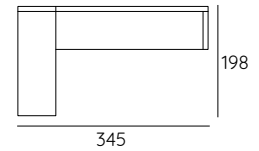
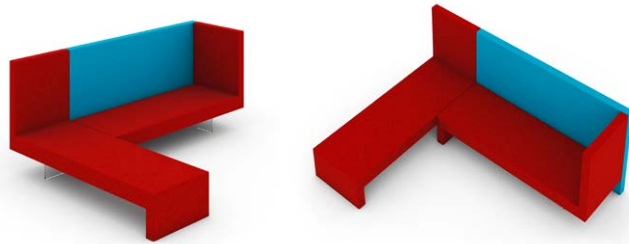

4

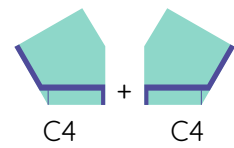
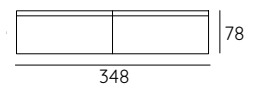
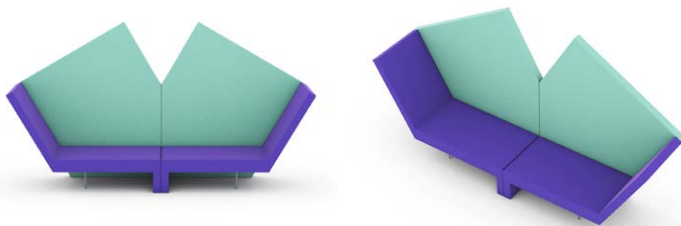

5

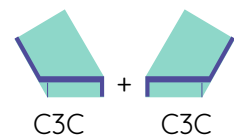
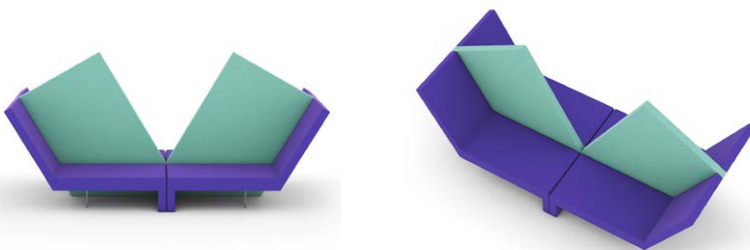

11M

DESIGN **ROBERTO ROMANELLO**

MICROMEGA

6

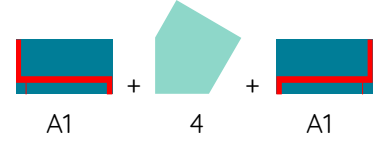
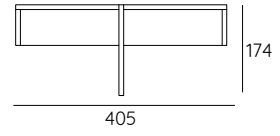
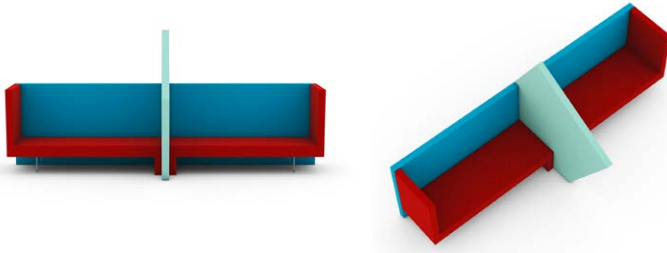

7

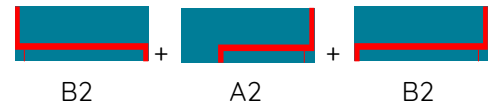
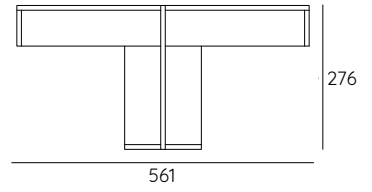
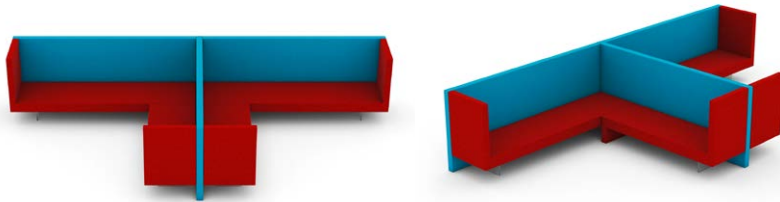

8

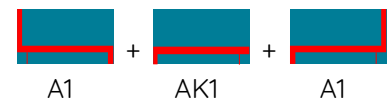
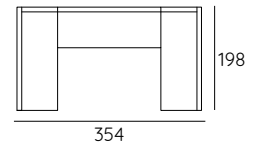
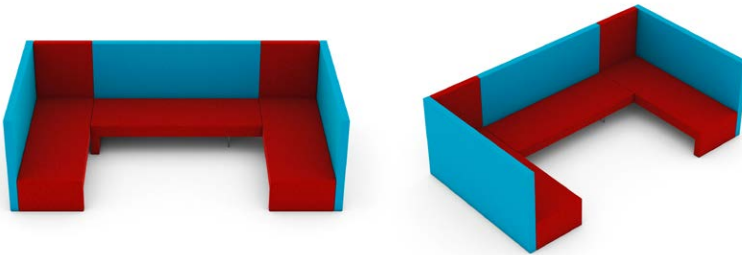

9

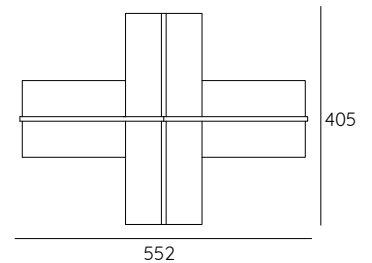
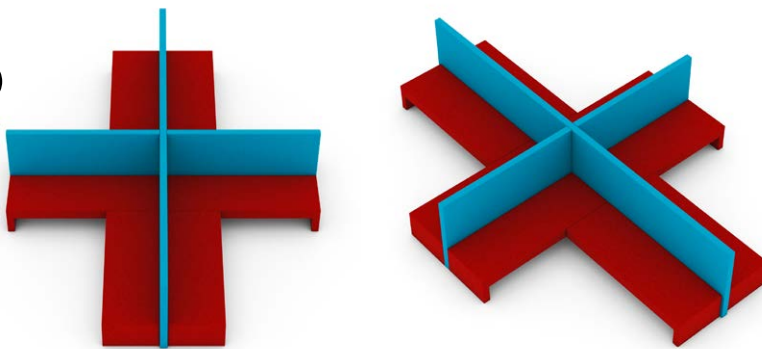

11M

DESIGN ROBERTO ROMANELLO

MICROMEGA

DESIGN SOLUTIONS COMMERCIAL:

1

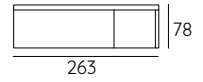
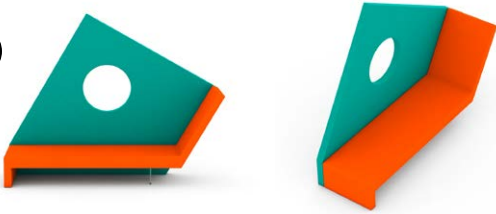

D8

2

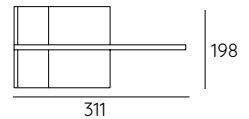
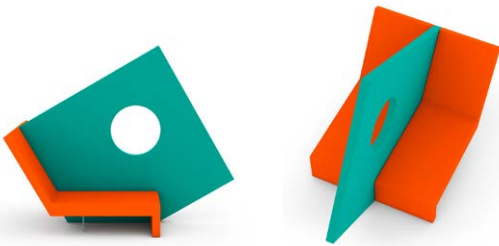

D10D

3

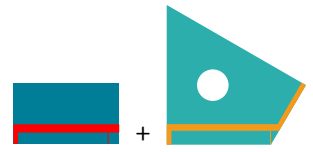
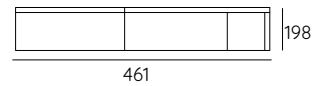
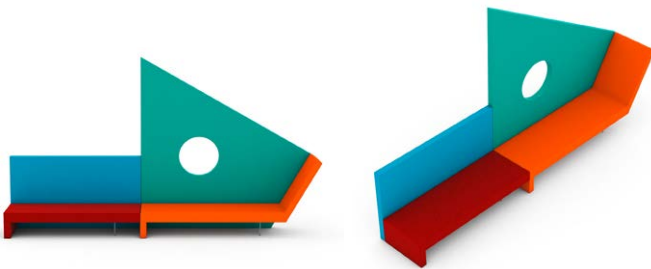

AK1

D11

4

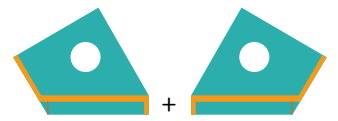
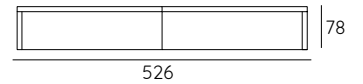

D8

D8

5

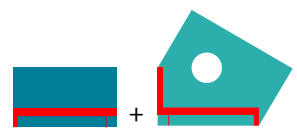
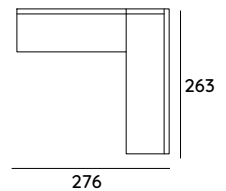
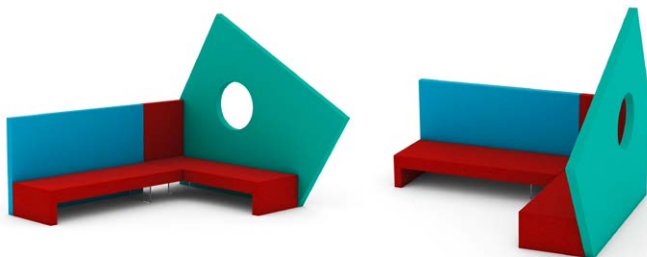

AK1

A9

MICROMEGA

6

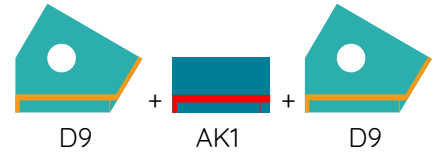
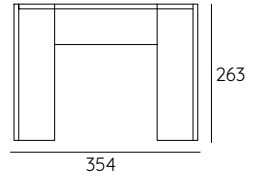
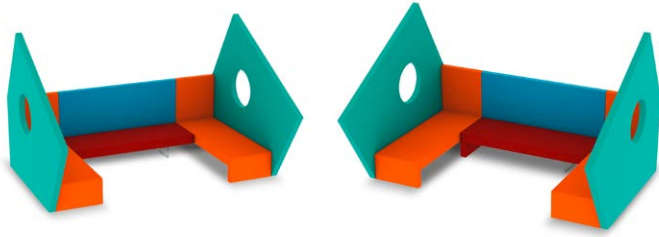

7

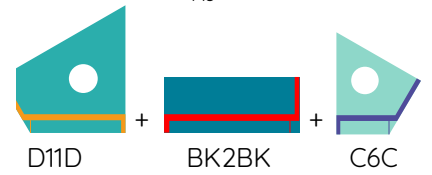
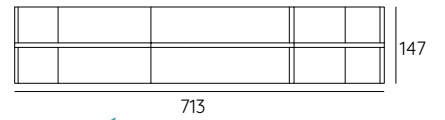
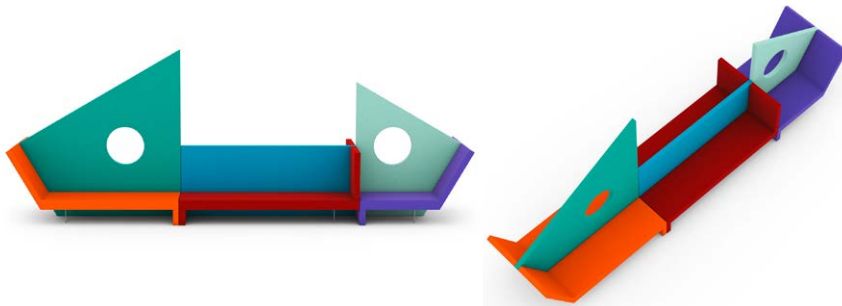

8

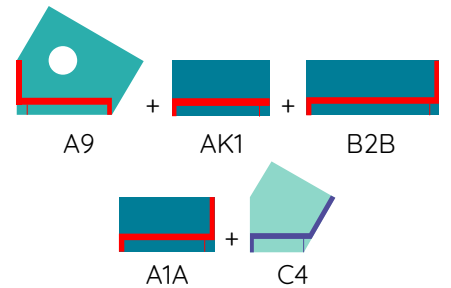
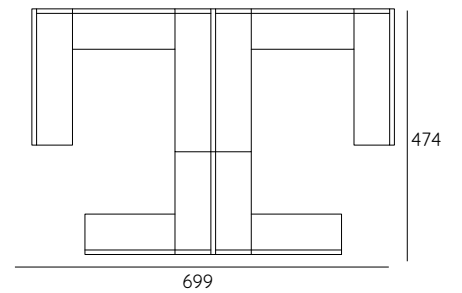
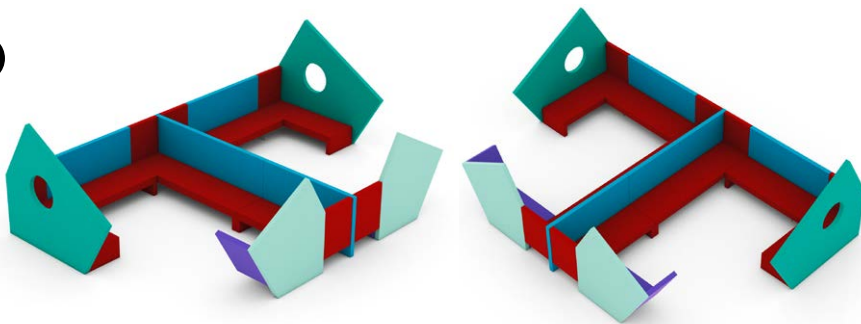

SUGGESTED CONFIGURATIONS:

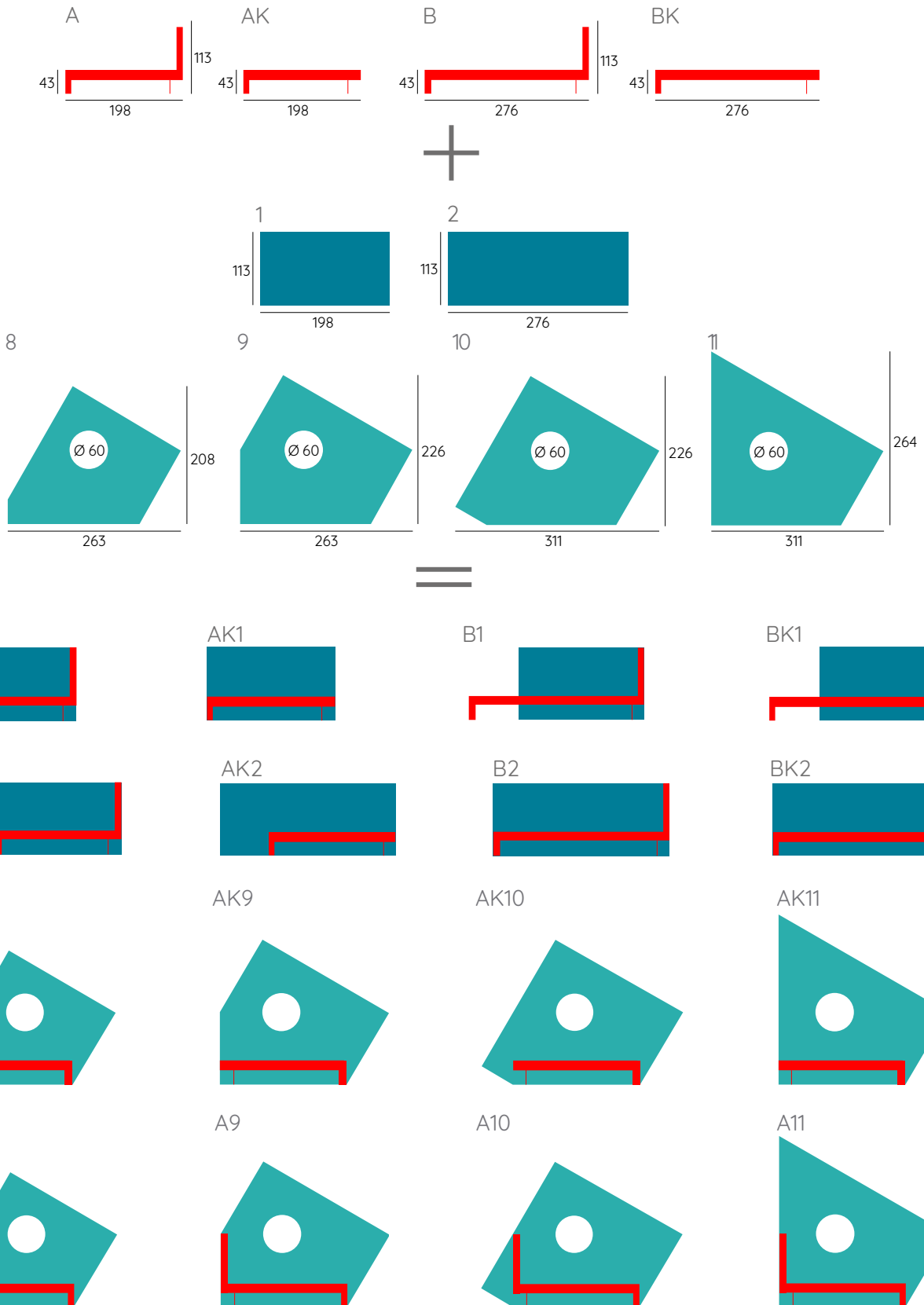

MICROMEGA

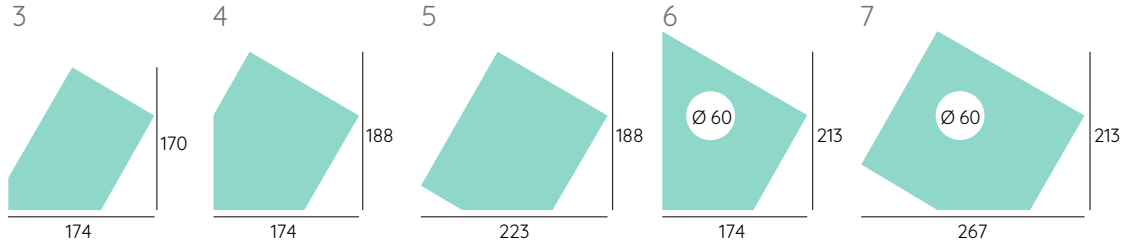
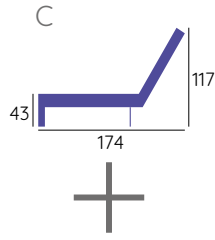

=

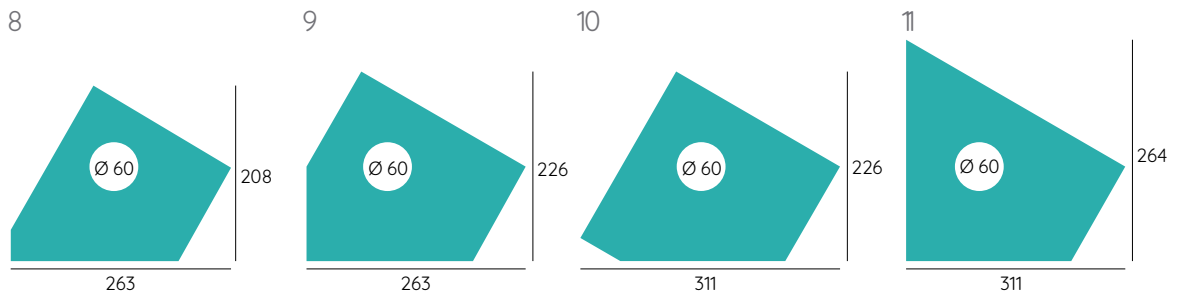
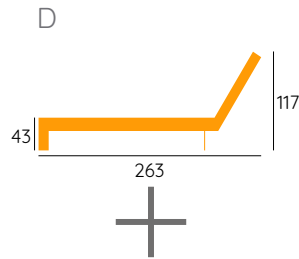

=

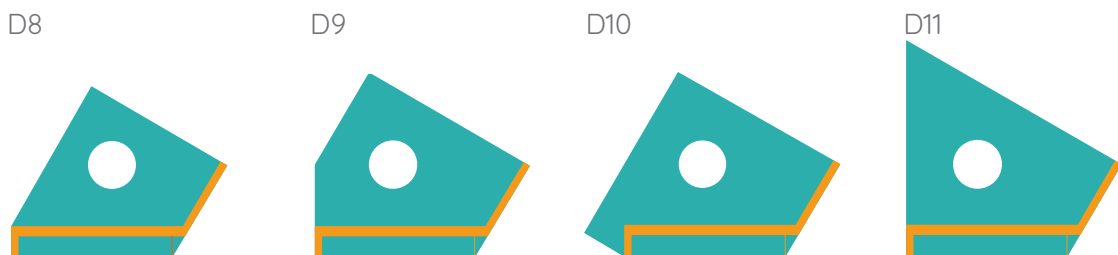



DESIGN **ROBERTO ROMANELLO**

MICROMEGA

SUGGESTED FABRICS:



Lemming 29500



Luna/Z CS



Amara



Mirage



Sprint



Sole CS



Nemi melange

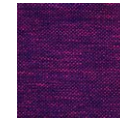

Angel combo



Angel chevy



Angel jumbo



Europost 2



Natur wool



Fenice



Vintage



Tiffany contract



Polaris Pro



Happy



Parasol 100