

Molteni & C

909 — LUCA MEDA 1991

1—
4



This is a line of modular chests of drawers whose elements can be used individually or combined to form a large container unit. It's a re-invention of the chest of drawers, standing between the rational and the traditional. Top in coloured glass, wood, glossy lacquered or matt lacquered. Drawers fronts in glossy lacquered or matt lacquered. A particular version with a refined open compartment and an aluminum structure supporting the drawers.

DATASHEET

REGISTERED
DESIGN

VII.2017

FINISHES

STRUCTURE FINISHES

matt lacquer colours in the Molteni colour range

DRAWER FINISHES

matt lacquer colours in the Molteni colour range - glossy lacquer colours in the Molteni colour range

TOP FINISHES

matt lacquer colours in the Molteni colour range - glossy lacquer colours in the Molteni colour range - eucalyptus - grey oak - graphite oak - light elm - dark elm - coloured glass in the Molteni colour range - etched coloured glass in the Molteni colour range

HANDLE AND INSERT OF THE PRESSURE-OPENING DOORS FINISH

shiny chrome or pewter colour painted

LEGS FINISHES

black - shiny chrome

TECHNICAL INFORMATION

STRUCTURE AND FRONT

Wood particleboard with melamine facing painted in the colours available in the “Molteni Range”.

SIDES AND INTERNAL DRAWER BOTTOM

Particleboard panel, coated with melamine resin.

HANDLE

In chrome plated or pewter colour painted metal.

OPEN COMPARTMENT

Frame in extruded glossy or pewter colour anodised aluminium with tempered coloured etched glass (th.4mm). Adjustable metallic feet.

GLASS TOP

Glass (th. 10mm), tempered coloured extralight or etched and coloured in the colours available in the “Molteni Range”.

WOODEN TOP

MDF panel veneered with wood – Oak (Quercus), Elm (Ulmus rubra), Eucalyptus (Eucalyptus globulus) – or faced with melamine painted in the “Molteni Range” colours.

ADJUSTABLE FEET

Non-skid plastic material.

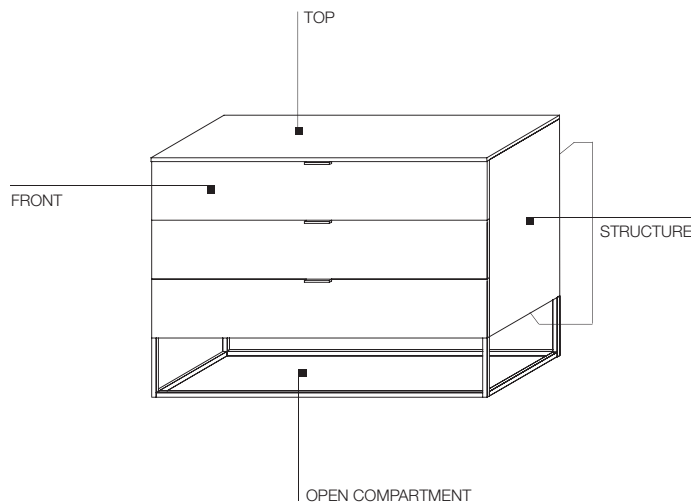

DATASHEET

REGISTERED
DESIGN

VII.2017

DIMENSIONS

Notes

- The finishing top is compulsory.
- Standard version comes with partially extractable runners.
- Fully extractable runners on request.

Molteni & C

3—
4

drawer unit with 1 drawer

W 480 D 480 H 342
W 18 7/8" D 18 7/8" H 13 1/2"



handle
NCM4/16

pressure-opening
NCP4/16

drawer unit with 1 drawer

W 960 D 480 H 342
W 37 3/4" D 18 7/8" H 13 1/2"



handle
NCM9/16

pressure-opening
NCP9/16

drawer unit with 2 drawers

W 480 D 480 H 340
W 18 7/8" D 18 7/8" H 13 3/8"



handle
NTM4/32

pressure-opening
NTP4/32

drawer unit with 2 drawers

W 480 D 480 H 502
W 18 7/8" D 18 7/8" H 19 3/4"



handle
NCM4/32

pressure-opening
NCP4/32

drawer unit with 2 drawers

W 960 D 480 H 340
W 37 3/4" D 18 7/8" H 13 3/8"

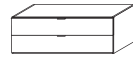

handle
NTM9/32

pressure-opening
NTP9/32

drawer unit with 2 drawers

W 960 D 480 H 502
W 37 3/4" D 18 7/8" H 19 3/4"

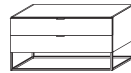

handle
NCM9/32

pressure-opening
NCP9/32

drawer unit with 3 drawers

W 480 D 480 H 500
W 18 7/8" D 18 7/8" H 19 3/4"



handle
NTM4/48

pressure-opening
NTP4/48

drawer unit with 3 drawers

W 480 D 480 H 662
W 18 7/8" D 18 7/8" H 26"



handle
NCM4/48

pressure-opening
NCP4/48

drawer unit with 3 drawers

W 960 D 480 H 500
W 37 3/4" D 18 7/8" H 19 3/4"



handle
NTM9/48

pressure-opening
NTP9/48

drawer unit with 3 drawers

W 960 D 480 H 662
W 37 3/4" D 18 7/8" H 26"

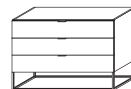

handle
NCM9/48

pressure-opening
NCP9/48

DATASHEET

REGISTERED
DESIGN

VII.2017

DIMENSIONS

drawer unit with 3 drawers
W 960 D 480 H 660
W 37 3/4" D 18 7/8" H 26"

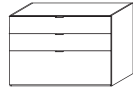

handle
NTM9/64/3 pressure-opening
NTP9/64/3

drawer unit with 3 drawers
W 960 D 480 H 822
W 37 3/4" D 18 7/8" H 32 3/8"

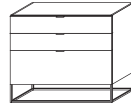

handle
NCM9/64/3 pressure-opening
NCP9/64/3

drawer unit with 4 drawers
W 960 D 480 H 660
W 37 3/4" D 18 7/8" H 26"

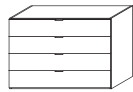

handle
NTM9/64/4 pressure-opening
NTP9/64/4

drawer unit with 4 drawers
W 960 D 480 H 822
W 37 3/4" D 18 7/8" H 32 3/8"

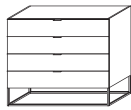

handle
NCM9/64/4 pressure-opening
NCP9/64/4

drawer unit with 5 drawers
W 480 D 480 H 980
W 18 7/8" D 18 7/8" H 38 5/8"

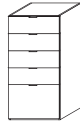

handle
NTM4/96 pressure-opening
NTP4/96

drawer unit with 5 drawers
W 960 D 480 H 980
W 37 3/4" D 18 7/8" H 38 5/8"

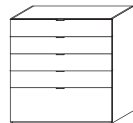

handle
NTM9/96 pressure-opening
NTP9/96

led lighting system
for open compartment

finishing tops
D 484 th 10
D 19" th 3/8"



TOQ48



TOQ96

for W 480 18 7/8"



HLG48

for W 960 37 3/4"

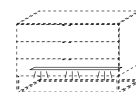

HLG96

DATASHEET

REGISTERED
DESIGN

VII.2017

Dimensions in millimeters and inches. The right to discontinue and make changes is reserved. This information is based on the latest product information available at the time of printing.

Molteni & C

FINISHES MOLTENI&C RANGE

IX.2017

	MATT LACQUER	GLOSSY LACQUER	COLOURED GLASS	ETCHED COLOURED GLASS	PLASTER LACQUERED CARTAPAGLIA LACQUERED <i>only Gliss Master</i>	STOPSOL GLASS TRANSPARENT STOPSOL GLASS
CHALK WHITE	•	•	•	•	•	
IVORY	•				•	
PEARL	•	•	•	•	•	
SILICA	•	•	•	•	•	
SAND	•	•	•	•	•	
PLATINUM	•	•	•	•	•	
DUNE	•	•	•	•	•	
CLAY	•	•	•	•	•	
DOLOMITE GREY	•	•	•	•	•	
RUST	•	•	•	•	•	
RUBY	•	•	•	•	•	
CARAMEL	•	•	•	•	•	
MOKA	•	•	•	•	•	
MUSTARD	•	•	•	•	•	
CADMIUM	•	•	•	•	•	
LIGHT BLUE GREY	•	•	•	•	•	
LEAD	•	•	•	•	•	
ANTHRACITE	•	•	•	•	•	
BLACK	•	•	•	•	•	
STOPSOL						•
LESSLESS RED	•					
					only matt lacquer	

Molteni & C

FINISHES MOLTENI&C RANGE

IX.2017

WOODS

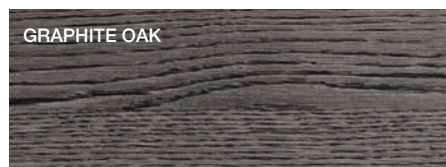
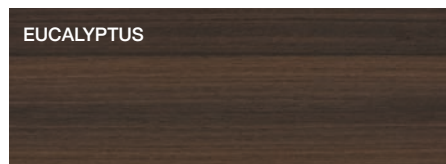

MARBLES

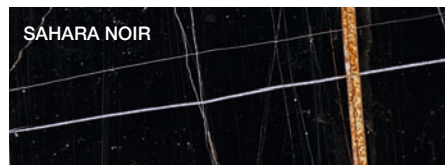
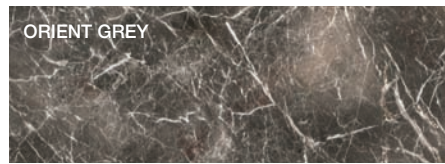
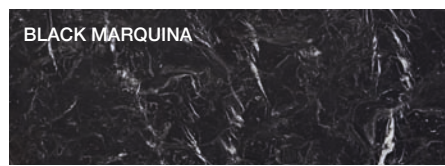
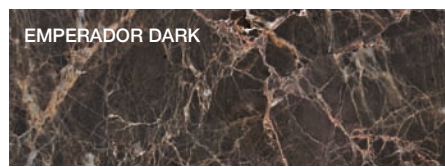
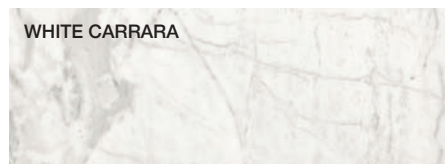

METAL PARTS

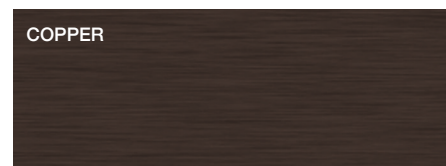
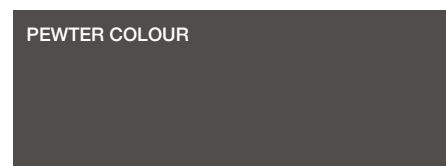
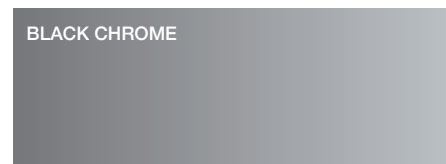

DWELL
DOOR FRAME, TRACK COVERING PROFILES



The finishes shown are indicative and refer to the entire production range. We recommend that you consult the "Colour Range" samples which shown the complete range of finishes, including those not shown here. Molteni&C reserves the right to modify the range without warning.

Molteni & C

FINISHES MOLTENI&C RANGE

IX.2017

MELAMINE FRONT GLISS MASTER

CARTAPAGLIA WHITE



CARTAPAGLIA ANTHRACITE



CARTAPAGLIA SILICA



GRAFFIATO SILICA



GRAFFIATO BRONZE



MELAMINE STRUCTURE GLISS MASTER

WHITE SHANTUNG



GREY SHANTUNG



MELAMINE STRUCTURE GLISS MASTER, MASTER DRESSING, GLISS WALK-IN

SILVER CEMBRAN



LARIX DARK



ECO SKIN GLISS MASTER, MASTER DRESSING

IVORY



HEMP



MINK



DARK BROWN



GREY



PLASTER GLISS MASTER FRONT

SILICA



MELAMINE STRUCTURE GLISS MASTER, MASTER DRESSING

RAFFIA



FINE GRAIN GLISS MASTER, MASTER DRESSING

FINE GRAIN

