

design: Gianluigi Landoni

**IT_Descrizione prodotto**

Divani, divano curvo, elementi centrali, terminali, chaises longues, angoli, pouf

Caratteristiche tecniche

Struttura: massello di abete e legno multistrato

Molleggio: nastri elastici unidirezionali ad alta portata

Imbottitura seduta e schienale: poliuretano espanso a quote differenziate ricoperto in termolegato cotone 100%

Piedi: tecnici neri

Rivestimento: in tessuto o in pelle. Rivestimento in tessuto completamente sfoderabile

Opzione:

- ripiano pouf: rovere tinto moka o noce Canaletto o legno laccato opaco o lucido (colori RAL a catalogo)
- cuscino schienale pouf: poliuretano espanso di differenti densità, base interna con lastra in metallo
- cuscini schienale: in fibra poliestere siliconata ricoperta da fodera cotone 100%.

Note particolari

All'ordine specificare tipo finitura ripiano pouf
I cuscini schienale non sono compresi nel costo dei divani

EN_Product description

Sofas, curved sofa, middle elements, end elements, chaises longues, corner elements, ottoman

Technical features

Frame: solid fir-wood and multilayer

Springing: high resistance unidirectional elastic bands

Seat and backrest padding: polyurethane foam with different densities covered with heated bonded with 100% cotton lining

Feet: black standard

Cover: fabric or leather cover. Fabric cover completely removable

Option

- ottoman top: moka dyed oak or Canaletto walnut wood or matt or glossy lacquered wood (RAL colours on catalog)
- ottoman back cushion: polyurethane foam with different densities inner base with metal slab
- back cushions: silicone polyester fibre covered with 100% cotton lining

Special notes:

On order please specify ottoman top finish
Back cushions are not included in the sofas price

Piedi / Feet

_Verniciatura
_Varnish



_metallo RAL 7021
_metal RAL 7021

Ripiano pouf / Ottoman top

_Essenze
_Woods



_rovere tinto moka
_moka dyed oak



_noce canaletto
_canaletto walnut

_Laccature
_Lacquer colours



RAL 1007



RAL 3011



RAL 7006



RAL 6021



RAL 1012



RAL 8007



RAL 5020



RAL 6031

design: Gianluigi Landoni

- A - Memory foam / Memory foam
- B - Espanso densità portante / Foam supporting density
- C - Espanso densità soft / Foam soft density
- L - Fusto in legno / Wooden frame

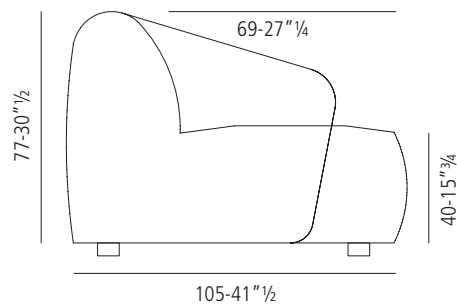
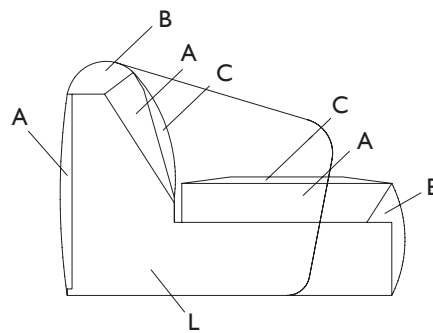

design: Gianluigi Landoni

cod 85005

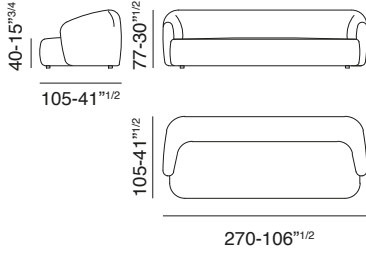

cod 85004

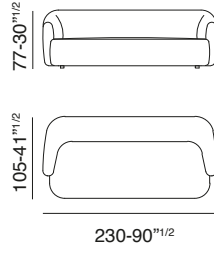

cod 85007

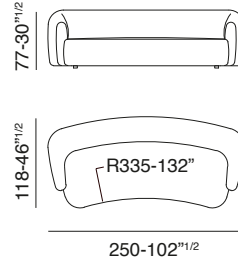

cod 85006

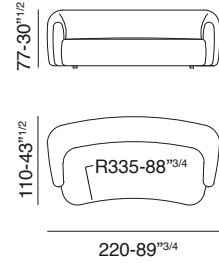

cod 85011

cod 85010

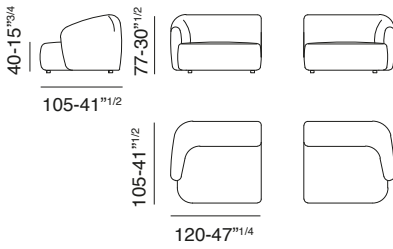

cod 85013

cod 85012

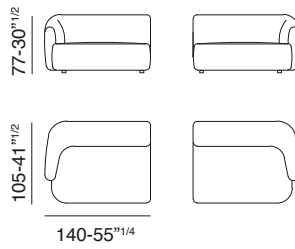

cod 85015

cod 85014

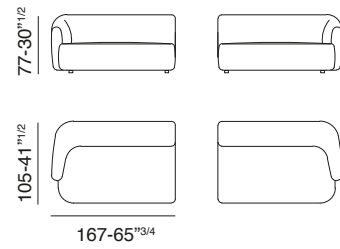

cod 85017

cod 85016

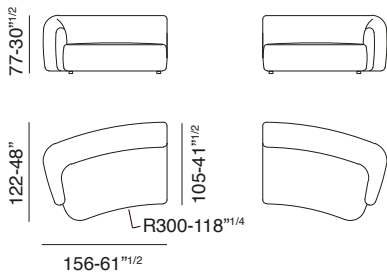

cod 85019

cod 85018

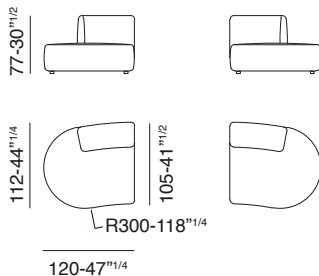

cod 85021

cod 85020

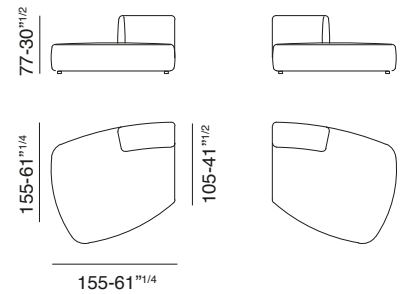

design: Gianluigi Landoni

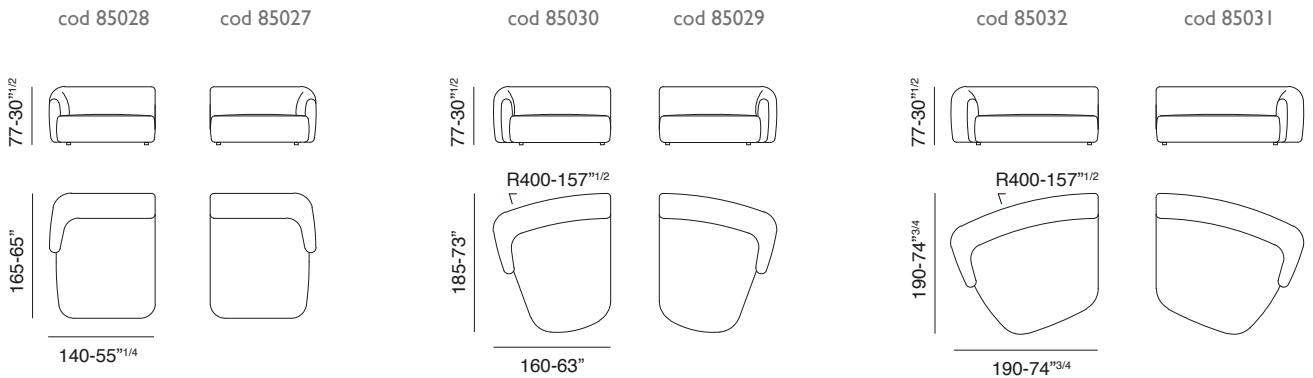
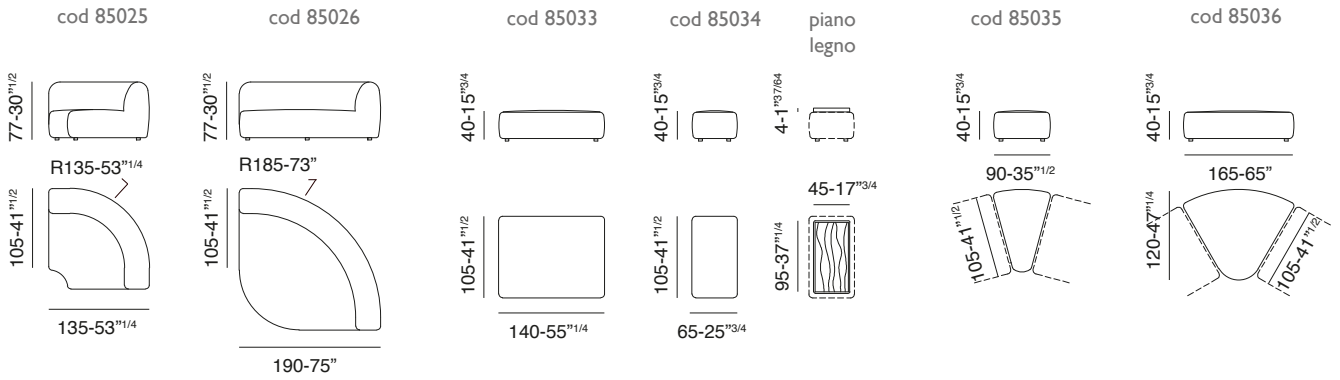
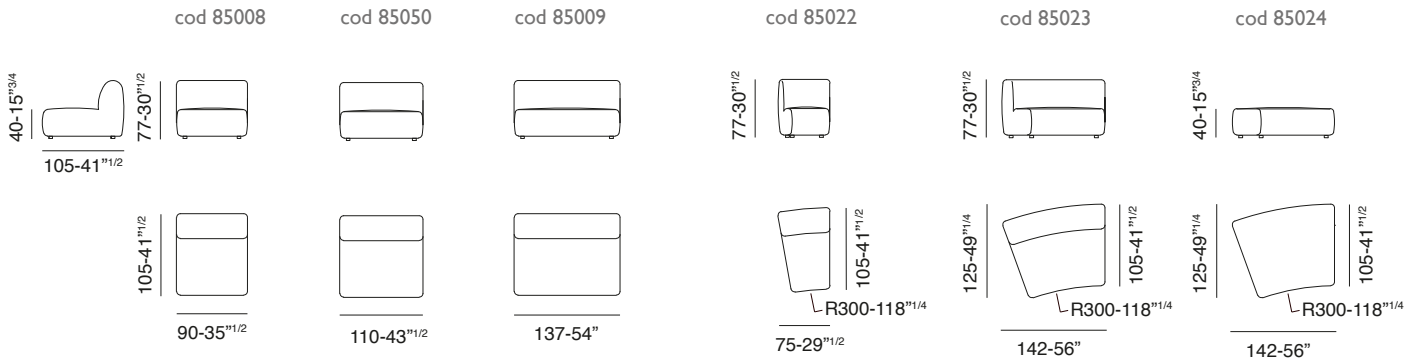

design: Gianluigi Landoni

cod 85037

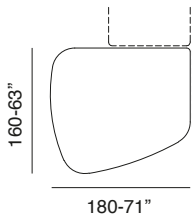

cod 85038

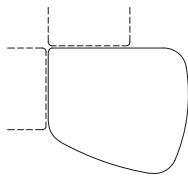

cod 85039

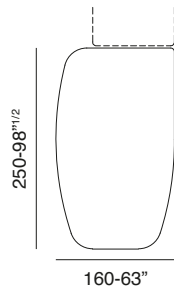
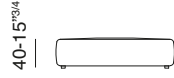

cod 85040

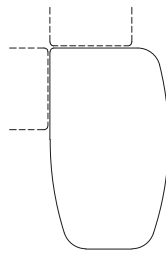

cod 85041

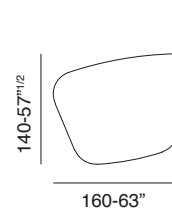
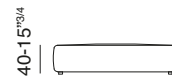

cod 85042

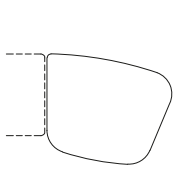
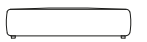

cod 85043

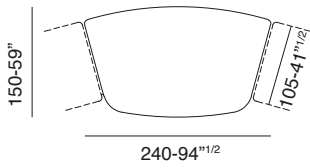
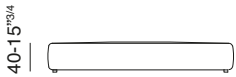

cod 85044

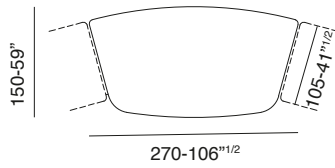
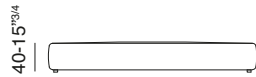

cod 85046

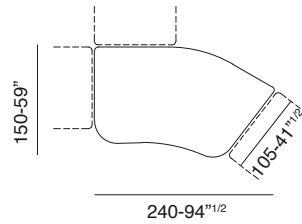
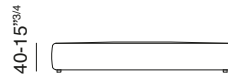

cod 85045

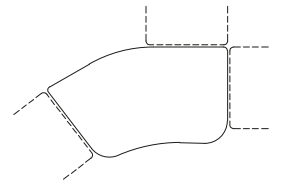

cod 85048

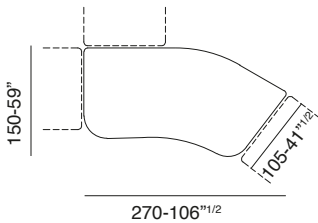
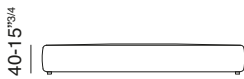

cod 85047

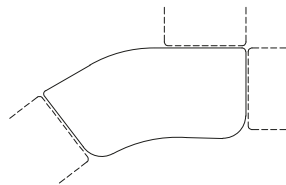

cod 85001

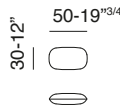

cod 85002

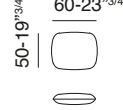

cod 85003

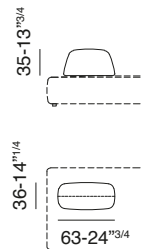

85_SHELL

design: Gianluigi Landoni

