

## CLASS design\_gianluigi landoni

### 680



**IT\_Descrizione prodotto**  
Divani, Poltrone, Pouf

**EN\_Description of the product**  
Sofas, Armchairs, Ottoman

**Caratteristiche tecniche**

**Struttura:** Massello di abete.  
**Molleggio:** Nastri elastici intrecciati.  
**Imbottitura:** Poliuretano espanso.  
**Cuscini seduta:** Inserto in poliuretano espanso avvolto da materassina in piuma.  
**Piedi:** Legno noce canaletto o metallo verniciato.  
**Rivestimento:** Rivestimento in tessuto o in pelle.  
Rivestimento in tessuto completamente sfoderabile.

**Technical features**

**Frame:** Solid fir-wood.  
**Springing:** Interlaced elastic bands.  
**Padding:** Polyurethane foam.  
**Seat cushions:** Core in polyurethane foam covered with a feather layer.  
**Feet:** Canaletto walnut or varnished metal.  
**Cover:** Fabric or leather cover. Fabric cover completely removable.

- B - Espanso densità portante / Foam supporting density
- C - Espanso densità soft / Foam soft density
- L - Fusto in legno / Wooden frame
- R - Resinato / Heated bonded polyester fibre
- P - Piuma / Feather

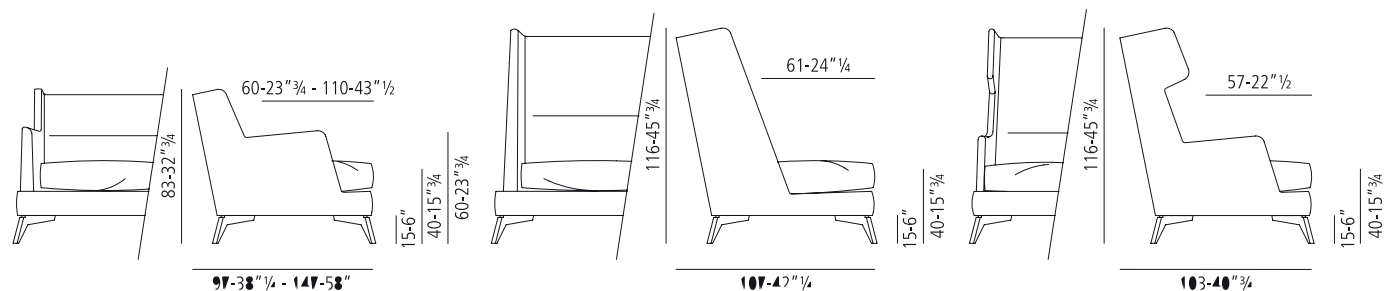
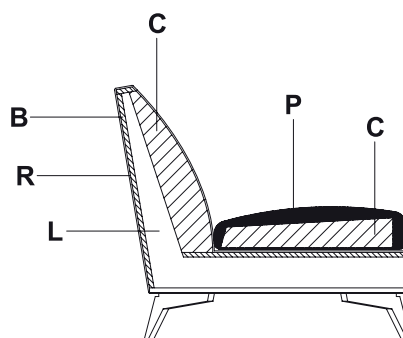

## 680

\_pouf  
\_ottoman



\_poltrona alta  
\_high armchair

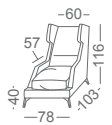

\_poltrona  
\_armchair

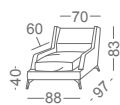

\_poltrona lunga  
\_long armchair

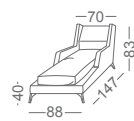

\_divano alto  
\_high back sofa

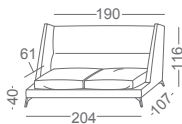

\_divano basso  
\_low back sofa

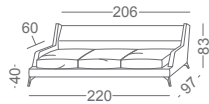

\_poltroncina  
\_small armchair

