

LOUIS & FLEA

Collection inspirée par le célèbre artiste de jazz, les suspensions *Louis* et les appliques *Fléa* jouent des effets de lumières avec le verre et le laiton. Modulables, créez vos compositions de « trompettes » à l'envi.



A collection inspired by the iconic jazz artist, the *Louis* pendants and *Fléa* wall lights play with lighting effects on the glass and the brass. Adjustable, you can arrange the “trumpets” as you wish.



LOUIS

Finitions Finishes

● Laiton satiné
SB Satin brass

● Graphite satiné
SG Satin graphite

● Nickel satiné
SN Satin nickel

● Cuivre satiné
SC Satin copper

Nuances du verre Glass colors

● Opale
Opal

● Opale et écaille
Opal and patterned

● Claire et écaille
Clear and patterned

Câble Cable

■ Tissu noir
Black textile

■ Tissu or
Gold textile

*La longueur standard des câbles est de 2 mètres mais elle peut être diminuée à l'installation.
The standard height of the cables is 2 meters (79") but can be adjusted to less during installation.*

Matériaux Material

Laiton massif
Solid Brass

Verrerie soufflée bouche
Mouth-blown glass

Câble textile
Textile cable

Source Lamping

LED intégrée 1500 lm 2700°K
Integrated LED 1500 lm 2700°K

Alim. électr. intégrée dans le pavillon
Int. power supply included in canopy

Variation. Veuillez nous contacter
Dimming. Please, contact us



Designer

Émilie Cathelineau

Louis XS

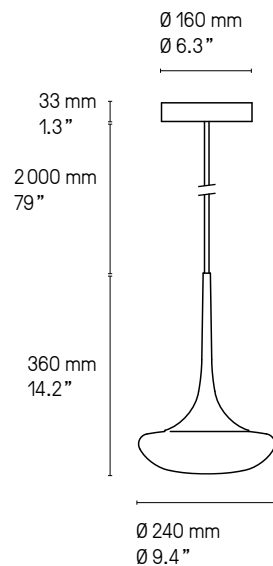

Louis XL

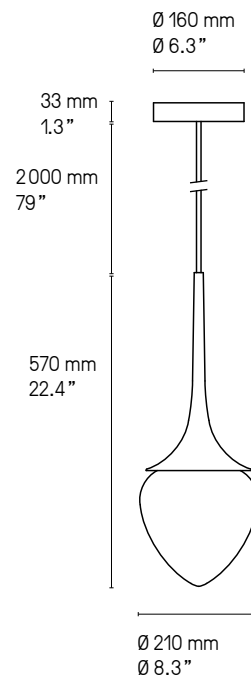

500 mm
19.7"

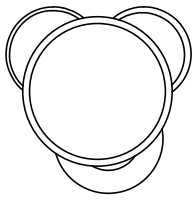

580 mm
22.8"

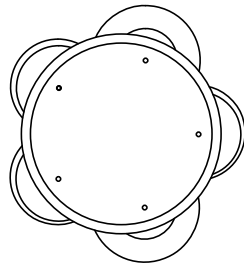

1100 mm
43.3"

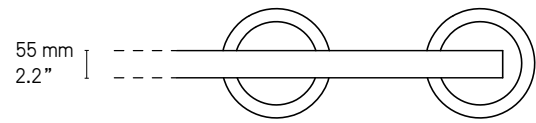

Ø 340 mm / 13.4"

Ø 300 mm / 11.8"

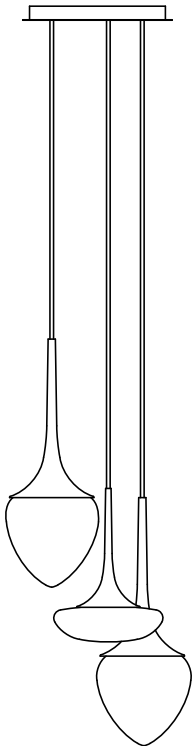

Ø 440 mm / 17.3"

Ø 400 mm / 15.7"

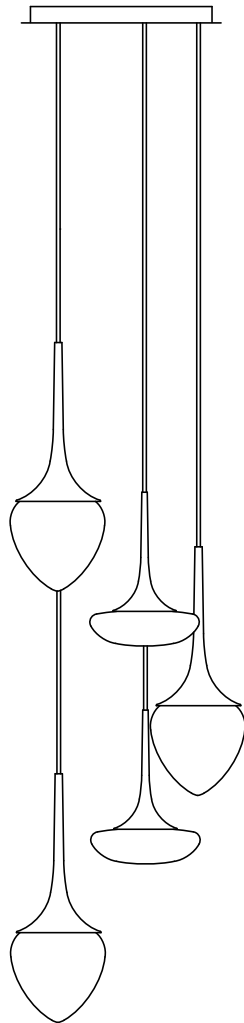

1000 mm / 39.4"

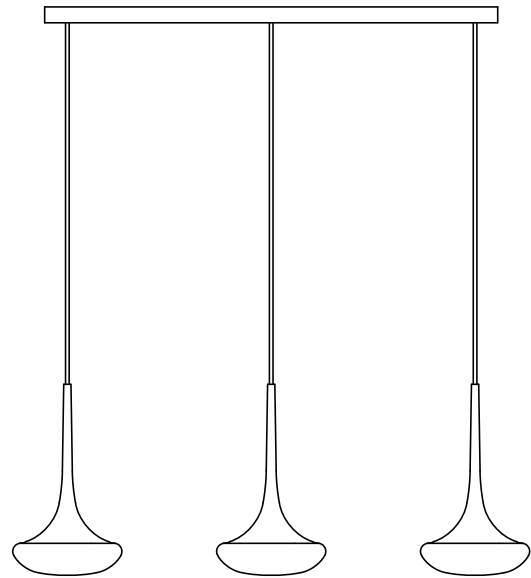

Il est possible de rassembler plusieurs suspensions sur un seul pavillon, circulaire ou rectangulaire. La version rectangulaire peut être adaptée à n'importe quelle longueur. La version circulaire a un diamètre maximum indiqué sur les croquis ci-dessus. Pour plus de renseignements, veuillez nous contacter.



It is possible to cluster several pendants from one single canopy, either rectangular or circular. The rectangular canopy can be custom-made into any size to suit your requirements. As for the circular canopy, available sizes are illustrated above. Please contact us for further information.



Suspension – Pendant Louis XS & XL SB

FLÉA

Finitions Finishes	 Laiton satiné	 Graphite satiné	 Nickel satiné	 Cuivre satiné
	SB Satin brass	SG Satin graphite	SN Satin nickel	SC Satin copper

Câble Cable	 Tissu noir	 Tissu or	<p><i>La longueur standard des câbles est de 2 mètres pour les suspensions et 15 cm pour les appliques mais elle peut être diminuée à l'installation. Autres longueurs sur demande.</i></p> <p><i>The standard height of the cables is 2 meters (79") for a pendant and 150 mm (5,9") for a wall light it can be adjusted to to less during installation. Custom heights available upon request.</i></p>
	Black textile	Gold textile	

Matériaux Material	Laiton massif	Verre pressé	Câble textile
	Solid Brass	Pressed clear glass	Textile cable

Source Lamping	G9 LED 5W max. non fournie	Not available for 110V	Variation*
	G9 LED 5W max. not included		Dimming*

Designer Émilie Cathelineau

* Les luminaires variables nécessitent l'utilisation d'ampoules compatibles avec la variation
All dimmable light fixture require the use of compatible bulbs

Applique – Wall light

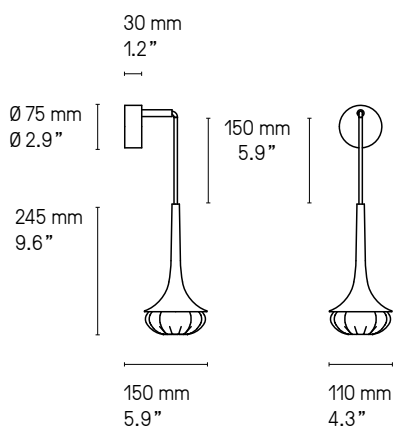

Applique – Wall light Flea SB

Suspension – Pendant

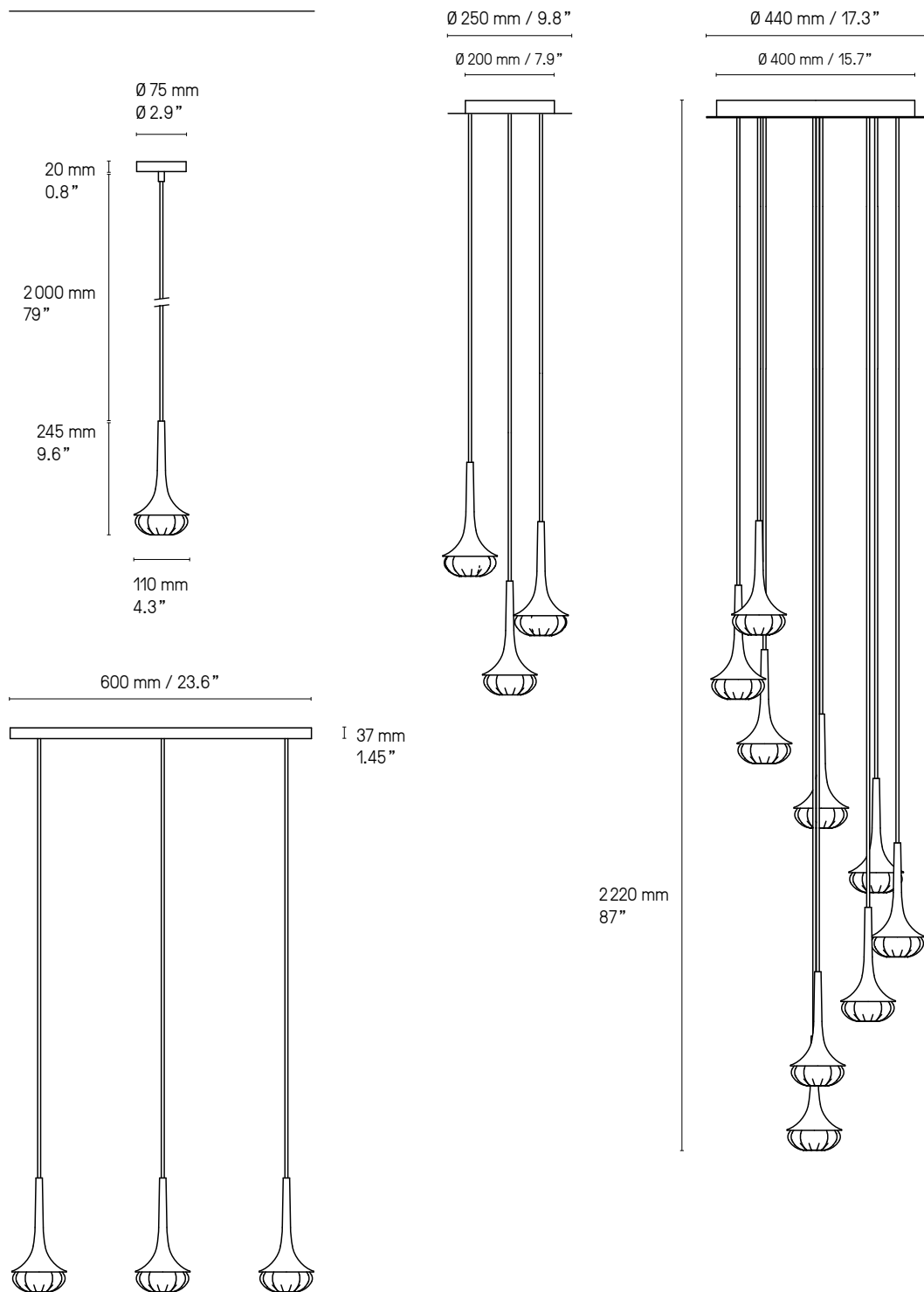

Il est possible de rassembler plusieurs suspensions sur un seul pavillon, circulaire ou rectangulaire. La version rectangulaire peut être adaptée à n'importe quelle longueur. La version circulaire a un diamètre maximum indiqué sur les croquis ci-dessus. Pour plus de renseignements, veuillez nous contacter.

It is possible to cluster several pendants from one single canopy, either rectangular or circular. The rectangular canopy can be custom-made into any size to suit your requirements. As for the circular canopy, available sizes are illustrated above. Please contact us for further information.

NUANCIER - FINISH OPTIONS



LAITON - BRASS

- | | |
|-------------------------------------|---|
| ① Laiton satiné
SB Satin brass | ② Graphite satiné
SG Satin graphite |
| ③ Nickel satiné
SN Satin nickel | ④ Cuivre satiné
SC Satin copper |
| ⑤ Laiton poli
PB Polished brass | ⑥ Graphite poli
PG Polished graphite |
| ⑦ Nickel poli
PN Polished nickel | ⑧ Cuivre poli
PC Polished copper |

ABAT-JOURS - LAMPSHADES



Drop Paper® 100



Drop Paper® 101

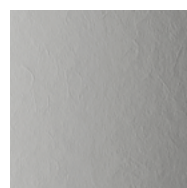

Drop Paper® 103



Chinette blanche
White chinette

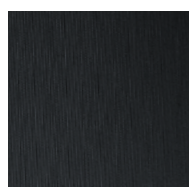

Chinette noire
Black chinette

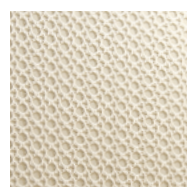

Duke
Duke

CÂBLES - CABLES

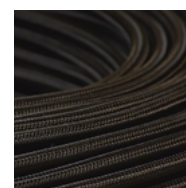

Tissu noir
Black textile



Tissu or
Gold textile

VERRERIE - GLASS



Opale
Opal

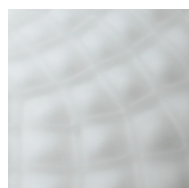

Opale et écaille
Opal and patterned



Claire et écaille
Clear and patterned

CONSEILS TECHNIQUES

Les caractéristiques techniques mentionnées dans ce document sont données à titre indicatif et sont susceptibles de subir des modifications. Ceci est lié à l'évolution rapide de la technologie LED.

Les dimensions sont approximatives et peuvent varier légèrement.

AMPOULES

Il est impératif de respecter les types et les puissances maximales préconisées sous peine de détériorer le luminaire. En cas de non-respect, la garantie ne pourra s'appliquer.

CONSEIL D'ENTRETIEN

Essuyage avec un chiffon doux, sans produits d'entretien. Nos produits étant vernis afin d'assurer la longévité du luminaire, il ne faut en aucun cas utiliser de produits détergents ou de solvants.

La société se réserve le droit de modifier, sans préavis, les caractéristiques de ses produits.

TECHNICAL ADVICE

The technical characteristics provided in this document are for information purposes only and are subject to change, due to permanent evolution of LED technology.

All dimensions are approximate and may vary slightly.

LIGHT BULBS

Use only the type of light bulb and maximum wattage shown otherwise you may damage the light fitting. Failure to use the correct light bulb and wattage will affect the warranty.

CARE INSTRUCTIONS

Wipe with a soft cloth –do not use any cleaning products. All our light fittings are lacquered to ensure the longevity of the product– under no circumstances use detergents or solvents.

The company reserves the right to modify its products at any time without notice.

CVL LUMINAIRES