

T8624D Chronotherm® IV Deluxe Programmable Multistage Thermostats

INSTALLATION INSTRUCTIONS

APPLICATION

The T8624D Chronotherm® IV Deluxe Programmable Multistage Thermostats provides electronic control of 24 Vac single-zone multistage systems.

Refer to Table 1 for a general description of the thermostats. All T8624 thermostats require a common wire to supply power.

Table 1. Description of T8624 Thermostats.

T8624	Changeover	System Selection	Fan Selection	Comments
D	Automatic	Heat-Off-Cool-Auto	On-Auto	System and fan selections are done by keyboard.



MERCURY NOTICE

If this control is replacing a control that contains mercury in a sealed tube, do not place your old control in the trash. Dispose of properly.

Contact your local waste management authority for instructions regarding recycling and the proper disposal of the old control.

3. Installer must be a trained, experienced service technician.
4. After completing installation, use these instructions to check out the product operation.

Location

Install the thermostat about 1.5m (5 ft) above the floor in an area with good air circulation at average temperature. See Fig. 1.

Do not install the thermostat where it can be affected by:

- drafts, or dead spots behind doors and in corners.
- hot or cold air from ducts.
- radiant heat from sun or appliances.
- concealed pipes and chimneys.
- unheated (uncooled) areas such as an outside wall behind the thermostat.

INSTALLATION

When Installing this Product...

1. Read these instructions carefully. Failure to follow the instructions can damage the product or cause a hazardous condition.
2. Check the ratings given in the instructions and on the product to make sure the product is suitable for your application.



Wallplate Installation

The thermostat can be mounted horizontally on the wall or on a 2 in. x 4 in. (50.8 mm x 101.6 mm) wiring box.

Position wallplate horizontally on the wall or on a 2 in. x 4 in. (50.8 mm x 101.6 mm) wiring box.

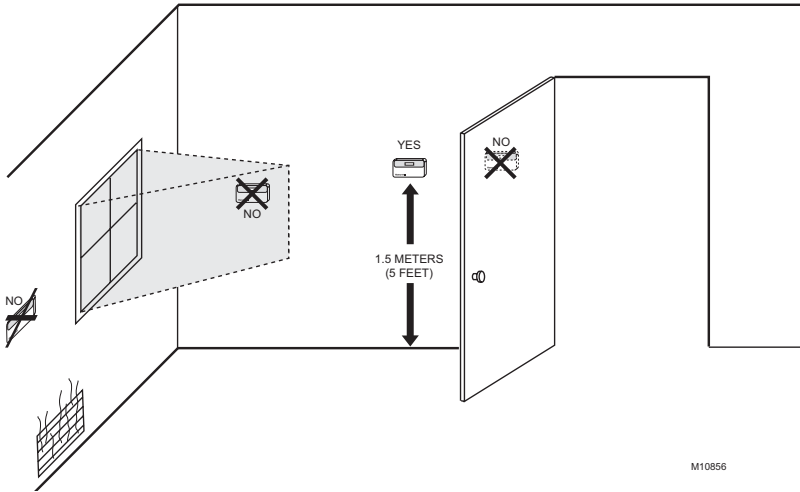

Fig. 1. Typical location of thermostat.

1. Position and level the wallplate (for appearance only). The thermostat will function correctly even when not level.
2. Use a pencil to mark the mounting holes. See Fig. 2.
3. Remove the wallplate from the wall and drill two 3/16 inch (76 mm) holes in the wall (if drywall) as marked. For firmer material such as plaster, drill two 7/32 inch (5.56 mm) holes. Gently tap anchors (provided) into the drilled holes until flush with the wall.
4. Position the wallplate over the holes, pulling wires through the wiring opening.
5. Loosely insert the mounting screws into the holes.
6. Tighten mounting screws.

WIRING

All wiring must comply with local electrical codes and ordinances. Refer to Fig. 3 for typical hookup. A letter code is located near each terminal for identification.



CAUTION

Electrical Shock Hazard.
Can cause electrical shock or equipment damage.

Disconnect power before beginning wiring.

1. Loosen the terminal screws on the wallplate and connect the system wires. See Fig. 4.

IMPORTANT

Use 18 gauge, color-coded thermostat cable for proper wiring.

2. Securely tighten each terminal screw.
3. Push excess wire back into the hole.
4. Plug the hole with nonflammable insulation to prevent drafts from affecting the thermostat.

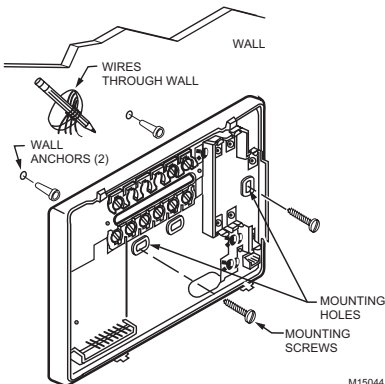

Fig. 2. Mounting the wallplate.

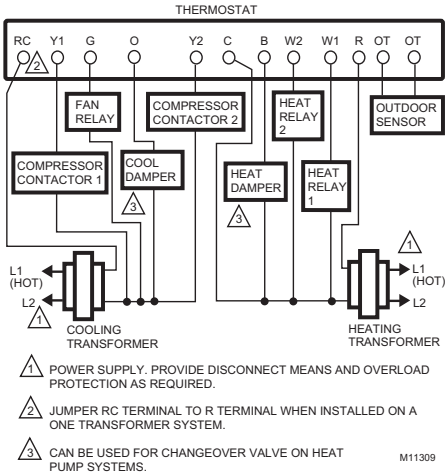

Fig. 3. Typical hookup of T8624D in a heat pump system.

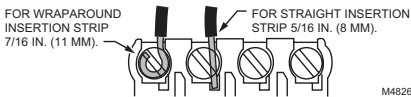

Fig. 4. Correct wiring technique.

Mounting Thermostat

1. Engage tabs at the top of the thermostat and wallplate. See Fig. 5.
2. Press lower edge of case to close and latch.

NOTE: To remove the thermostat from the wall, first pull out at the bottom of the thermostat; remove top last.

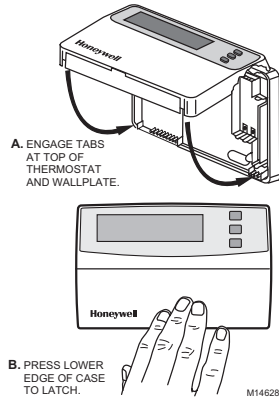

Fig. 5. Mounting thermostat on wallplate.

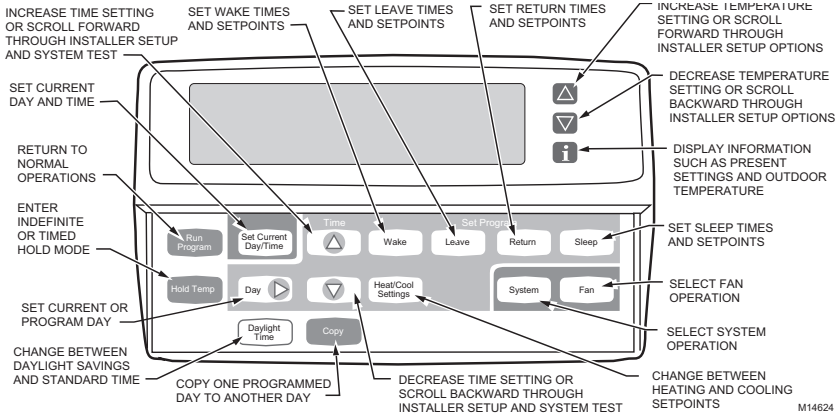

Fig. 6. T8624D key locations and descriptions.

Using Thermostat Keys

The thermostat keys are used to:

- set current day and time,
- program times and setpoints for heating and cooling,
- temporarily override program temperatures,
- display present setting,
- configure Installer Setup,
- check System Test,
- display outdoor temperature (select models),
- set the system operation,
- set the fan operation.

See Fig. 6 for the location of the keys.

SETTINGS

System and Fan Settings

The system default setting is Heat and the fan default setting is Auto. Use the System and Fan keys to change the settings. See Fig. 7. The fan settings can be set for each program period individually. The system selection is for all the program periods.

System settings control the thermostat operation as follows:

- Heat: The thermostat controls the heating.
- Off: Both the heating and cooling are off.
- Cool: The thermostat controls the cooling.
- Auto: The thermostat automatically changes between heating and cooling operation, depending on the indoor temperature.

Fan settings control the system fan as follows:

- On: Fan operates continuously.
- Auto: Fan operates with equipment.

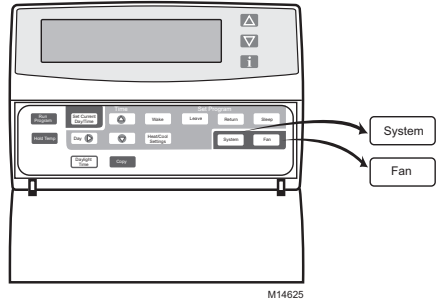

Fig. 7. T8624D System and Fan key locations.

NOTE: Always press the keys with your fingertip or similar blunt tool. Sharp instruments like a pen or pencil point can damage the keyboard.

Temperature Settings

Refer to Table 2 for the default program. If the daytime energy savings period is not used, press the period key (Leave or Return) until the time is blank. The fan setting feature is available on select thermostat models. See Owners Guide, form number 69-0940, for complete instructions on changing the program.

Table 2. Default Program Settings.

Period	Time	Heat Setpoint	Cool Setpoint	Fan Setting
Wake	6:00 AM	70°F (21°C)	78°F (25.5°C)	Auto
Leave	8:00 AM	62°F (16.5°C)	85°F (29.5°C)	Auto
Return	6:00 PM	70°F (21°C)	78°F (25.5°C)	Auto
Sleep	10:00 PM	62°F (16.5°C)	82°F (28°C)	Auto

INSTALLER SETUP

NOTE: For most applications, the thermostat factory settings will not need to be changed. Review the factory settings in Table 2 and if no changes are necessary, go to the Installer System Test section.

The Installer Setup is used to customize the thermostat to specific systems. Some of the options include temperature display, changeover, and outdoor temperature display. Installer Setup numbers are listed in Table 3. The table includes all the configuration options and the factory settings for the T8624.

A combination of key presses are required to use the Installer Setup feature.

- To enter the installer setup, press and hold the information **i** key with the increase **▲** and decrease **▼** keys until the first number is displayed. All display segments appear for approximately three seconds before the number is displayed. See Fig. 8 and 9.
- To advance to the next Installer Setup, press the Time **Δ** key.
- To change a setting, use the increase **▲** or decrease **▼** key.
- To scroll the Installer Setup numbers backward, press the Time **∇** key.
- To exit the Installer Setup, press Run Program.



Fig. 8. Display of all LCD segments..

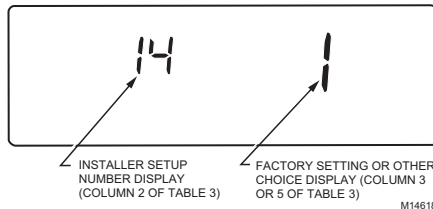

Fig. 9. Display of Installer Setup number and setting.

IMPORTANT

Only configurable numbers are shown on the device. Example: If thermostat does not have a System key, Installer Setup Number 12 will not be displayed. Review Table 3 factory settings and mark any desired changes in the Actual Setting column. When Installer Setup is complete, review the settings to confirm that they match the system.

Table 3. Thermostat Installer Setup Options.

Select	Installer Setup Number (Press Time Δ key to change)	Factory Setting		Other Choices (Press ▲ or ▼ key to change)		Actual Setting
		Display	Description	Display	Description	
Not Used.	1	—	—	—	—	—
Fan operation.	2	0	Conventional applications where equipment controls fan operation in heat mode	1	Heat pump and electric heat applications where thermostat controls fan operation in heat mode	—
Not Used.	3	—	—	—	—	—
Heating cycle rate. ^a	4	6	Stage 1	—	6—6 cph is fixed for stage 1.	—
	5		Stage 2	3 or 9	3—3 cph 6—6 cph factory setting for all stages of system 9—9 cph used for electric heat	
Not Used.	6 thru 11	—	—	—	—	—
System setting adjustment	12	1	Manual changeover	0 or 2	0—Auto changeover 2—Fixed auto changeover	—

^a The cycle rate for the last stage of heat is adjustable with 6 cph as the factory setting.

Table 3. Thermostat Installer Setup Options. (Continued)

Select	Installer Setup Number (Press Time Δ key to change)	Factory Setting		Other Choices (Press \blacktriangle or \blacktriangledown key to change)		Actual Setting
		Display	Description	Display	Description	
Adaptive Intelligent Recovery™ control.	13	0	Adaptive Intelligent Recovery™ control is activated (system starts early so setpoint is reached by start of program period).	1	Conventional recovery (system starts recovery at programmed time).	—
Degree temperature display	14	0	Temperature is displayed in °F	1	Temperature is displayed in °C	
Not Used.	15	—	—	—	—	—
Clock format.	16	0	12-hour clock format.	1	24-hour clock format.	
Not Used.	17 thru 18	—	—	—	—	—
Extended fan operation in heating	19	0	No extended fan operation after the call for heat ends.	1	Fan operation is extended 90 seconds after the call for heat ends.	
Extended fan operation in cooling	20	0	No extended fan operation after the call for cool ends.	1	Fan operation is extended 90 seconds after the call for cool ends.	
Not Used.	21 thru 23	—	—	—	—	—
Outdoor temperature display (models with OT terminals).	24	0	No outdoor temperature is displayed.	1	Outdoor temperature is displayed. Needs a C7089B1000 Outdoor Temperature Sensor to operate.	
Not Used.	25 thru 29	—	—	—	—	—
Deadband	30	3	Heating and cooling setpoints can be set no closer than 3°F (1.5°C).	4 thru 10	Heating and cooling setpoints can be set no closer than the chosen value: 4—4°F (2°C) 5—5°F (2.5°C) 6—6°F (3°C) 7—7°F (3.5°C) 8—8°F (4°C) 9—9°F (4.5°C) 10—10°F (5°C)	
Not Used.	31 and 32	—	—	—	—	—
Minimum off time for the compressor.	33	5	5 minutes minimum off time for the compressor.	0 thru 4	Minimum number of minutes (0 thru 5) the compressor will be off between calls for the compressor.	
Temperature range stops in heating.	34	90	Highest setpoint setting for heating.	40 to 89	Temperature range (1°F increments) of heating setpoint settings.	
Temperature range stops in cooling.	35	45	Lowest setpoint setting for cooling.	46 to 99	Temperature range (1°F increments) of cooling setpoint settings	
Not Used.	36	—	—	—	—	—

Table 3. Thermostat Installer Setup Options. (Continued)

Select	Installer Setup Number (Press Time Δ key to change)	Factory Setting		Other Choices (Press ▲ or ▼ key to change)		Actual Setting
		Display	Description	Display	Description	
Temperature display adjustment.	37	0	No difference in displayed temperature and actual room temperature.	-3 thru +3	1—Display adjusts to 1°F higher than actual room temperature. 2—Display adjusts to 2°F higher than actual room temperature. 3—Display adjusts to 3°F higher than actual room temperature. -1—Display adjusts to 1°F lower than actual room temperature. -2—Display adjusts to 2°F lower than actual room temperature. -3—Display adjusts to 3°F lower than actual room temperature.	
Furnace Air Filter Timer.	43	2	30 days (System run time).	0, 1, 3, 4	0 – Off 1 – 10 days 3 – 60 days 4 – 120 days (Time counted when heat, cool or fan is running.)	
Humidifier Pad Monitor.	44	0	Off	1, 2, 3	1 – 90 days 2 – 180 days 3 – 365 days (Time counted by calendar days in heat mode.)	
Ultraviolet Air Treatment (UV) System Lamp Monitor.	45	0	Off	1	1 – 365 days (Time counted by calendar days in any mode.)	

IMPORTANT

Review the settings to confirm that they match the system. Press Run Program to exit the Installer Setup. The thermostat has saved the Installer Setup changes and initiated a reset in order to operate using the new settings. Be sure to set the current day and time immediately.

NOTE: Sun=Sunday, Mon=Monday, Tue=Tuesday, Wed=Wednesday, Thu=Thursday, Fri=Friday, Sat=Saturday.

Setting Current Day and Time

1. Press Set Current Day/Time.

NOTE: On initial powerup or after an extended power loss, 1:00 pm flashes on the display until a key is pressed.

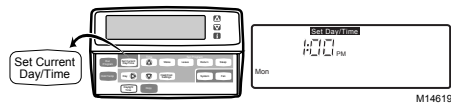

2. Press Day until the current day is displayed.

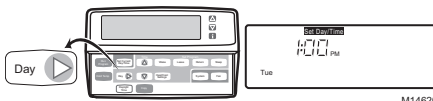

3. Press Time Δ or Time ▼ until the current time is displayed.

NOTE: Tapping the Set Current Day/Time changes the time in one-hour increments.

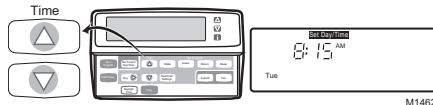

NOTE: If the current time is Daylight Savings Time, press Daylight Time until DST is displayed.

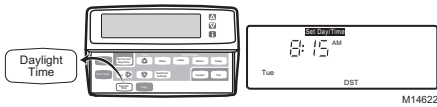

4. Press Run Program.

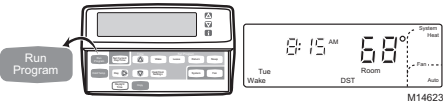

Viewing or Resetting Timer Settings

When the thermostat activates a timer, the thermostat flashes **Filter** until the timer resets.

1. Reset the timer by pressing the **i** key until the expired timer is displayed.



2. Press the Time key to reset the timer.

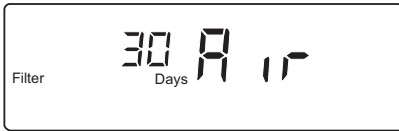

3. Press the Run Program key.

NOTE: You can view the number of days remaining at any time by pressing the **i** key three or four times. If more than one timer is active, all active timers show sequentially when pressing the **i** key several times.

INSTALLER SYSTEM TEST

Use the Installer System Test to check the thermostat operation. Refer to Table 4 for a list of the available system tests.

To start the system test:

CAUTION

The minimum off time for compressors is bypassed during the Installer System Test. Equipment damage can occur if the compressor is cycled too quickly.

Press and hold the increase **▲** and decrease **▼** keys at the same time until 10 appears. All segments of the display will be displayed before the 10 appears. See Fig. 10 and 11.

Table 4. Tests Available In Installer System Test.

Test Number	System Test Description
10-19	Heating equipment can be turned on and off.
30-39	Cooling equipment can be turned on and off.
40-49	Fan equipment can be turned on and off.
60 0 to 60 19	Keyboard keys test.
70-79	Thermostat information including date code and software versions are displayed.



Fig. 10. Display of all the segments of the LCD.



Fig. 11. Display of test number.

Refer to Table 5 for the directions and results of the specific tests.

Press Time **Δ** to advance to the next test and Time **∇** to go back to the previous test. Press Run Program to exit the system test

Table 5. Installer System Test Options.

Keys to Press	Test Number	Description
Heating Equipment System Test		
Time Δ	10	Enter heating equipment System Test.
\blacktriangle	11	Stage-one heat comes on. The system fan is also energized.
\blacktriangle	12	Stage-two heat comes on. Stage-one heat and system fan remain on.
\blacktriangledown	11	Stage-two heat turns off.
\blacktriangledown	10	Stage-one heat and system fan turn off.
Cooling Equipment System Test		
Time Δ	30	Change from heating to cooling equipment System Test.
\blacktriangle	31	Stage-one cool and system fan come on.
\blacktriangledown	32	Stage-two cool comes on. Stage-one cool and system fan remain on.
\blacktriangledown	31	Stage-two cool turns off.
\blacktriangledown	30	Stage-one cool and system fan turn off.
Fan Equipment System Test		
Time Δ	40	Change from cooling to fan equipment System Test.
\blacktriangle	41	Fan comes on.
\blacktriangledown	40	Fan turns off.
Key Operation System Test		
Time Δ	60	Change from fan to key operation System Test.

NOTE: Press any key and the displayed numbers will change. Press Time ∇ to go to the previous test and Time Δ to go to the next test. The Run Program key will not exit this test. Press Time Δ or Time ∇ and then the Run Program key to exit.

THERMOSTAT INFORMATION

1. Press the Time Δ key to access the thermostat information.



M14613

2. Press the increase \blacktriangle key to display the production date code. The first two large digits are the month and the third digit is the last digit of the year (Example: 027 = February 1997).



M14614

3. Press the increase \blacktriangle key again to display the software identification code. (Example: 02 = software ID code 2)



M14615

4. Press the increase \blacktriangle key again to display the software revision number (Example: 001 = Revision number 1).



M14616

5. Press the increase \blacktriangle key again to display the EEPROM identification code. (Example: 314 = EEPROM ID 314)



M14617

6. Press the Run Program key to exit the system test. The system test times out after four minutes without any key presses.

CHECKOUT

Outdoor Temperature Sensor (Select Models)

Allow the outdoor temperature sensor to absorb the outdoor air for a minimum of five minutes before taking a reading.

TROUBLESHOOTING GUIDE

Table 6. Troubleshooting Guide.

Symptom	Possible Cause	Action
Display will not come on.	Thermostat is not being powered.	<ul style="list-style-type: none"> • Check for 24 Vac between R and C terminals. <ul style="list-style-type: none"> — If missing 24 Vac: <ul style="list-style-type: none"> — check if the circuit breaker is tripped—reset the circuit breaker. — check if the system fuse is blown—replace the fuse. — check if the power switch on the HVAC equipment is in the Off position—set to the On position. — check wiring between thermostat and HVAC equipment—replace any broken wires and tighten any loose connections. — If 24 Vac is present, proceed with troubleshooting
Temperature display is incorrect.	Room temperature display has been reconfigured.	Enter Installer Setup number 37 and reconfigure the display.
	Thermostat is configured for °F or °C display.	Enter Installer Setup number 14 and reconfigure the display.
	Bad thermostat location.	Relocate the thermostat.
Temperature settings will not change. (Example: Cannot set the heating higher or the cooling lower.)	The upper or lower temperature limits were reached.	<ul style="list-style-type: none"> • Check the temperature setpoints: <ul style="list-style-type: none"> • Heating limits are 40 to 90°F (7 to 31°C). • Cooling limits are 48 to 99°F (9 to 37°C).
	The setpoint temperature range stops were configured.	Check Installer Setup numbers 34 and 35 and reconfigure the setpoint stops.
Heating will not come on.	No power to the thermostat.	<ul style="list-style-type: none"> • Check for 24 Vac between R and W terminals. <ul style="list-style-type: none"> — If missing 24 Vac: <ul style="list-style-type: none"> — check if the circuit breaker is tripped—reset the circuit breaker. — check if the system fuse is blown—replace the fuse. — check if the power switch on the HVAC equipment is in the Off position—set to the On position. — check wiring between thermostat and HVAC equipment—replace any broken wires and tighten any loose connections. — If 24 Vac is present, proceed with troubleshooting.
	Thermostat minimum off time is activated.	Wait up to five minutes for the system to respond.
	System selection is not set to Heat.	Set system selection to Heat.
	Heating setpoint is below room temperature.	Check heating setpoint. Set heating setpoint to desired temperature.
Cooling will not come on.	No power to the thermostat.	<ul style="list-style-type: none"> • Check for 24 Vac between R or RC. <ul style="list-style-type: none"> — If missing 24 Vac: <ul style="list-style-type: none"> — check if the circuit breaker is tripped—reset the circuit breaker. — check if the system fuse is blown—replace the fuse. — check if the power switch on the HVAC equipment is in the Off position—set to the On position. — check wiring between thermostat and HVAC equipment—replace any broken wires and tighten any loose connections. — If 24 Vac is present, proceed with troubleshooting.
	Thermostat minimum off time is activated.	<ul style="list-style-type: none"> • Wait up to five minutes for the system to respond. • Enter Installer Setup number 33. Reconfigure minimum off time (if required).
	System selection is not set to Cool.	Set system selection to Cool.
	Cool setpoint is above room temperature.	Check cooling setpoint. Set cooling setpoint to desired temperature.

Table 6. Troubleshooting Guide. (Continued)

Symptom	Possible Cause	Action
System on indicator (flame=heat, snowflake=cool) is displayed, but no warm or cool air is coming from the registers.	Heating or cooling equipment is not operating.	Verify operation of heating or cooling equipment in self-test.
Outdoor temperature not displayed ^a	Option not activated.	Enter Installer Setup number 24 and set to 1. Thermostat must have OT terminals and a C7089B1000 installed.
Outdoor temperature display is incorrect ^a	Outdoor sensor is connected incorrectly.	Refer to C7089B1000 Installation Instructions and check wiring between the thermostat and sensor.
	Wrong sensor.	Replace sensor with C7089B1000 Sensor.

^aSelect models.

Honeywell

Automation and Control Solutions

Honeywell
 1985 Douglas Drive North
 Golden Valley, MN 55422

Honeywell Limited-Honeywell Limitée
 35 Dynamic Drive
 Scarborough, Ontario
 M1V 4Z9

